

BH-B521



Replaces

BOSCH :
1-194-336-035

CHRYSLER :
5123991

Unit no.

BOSCH
0-120-400-944

BH-B531

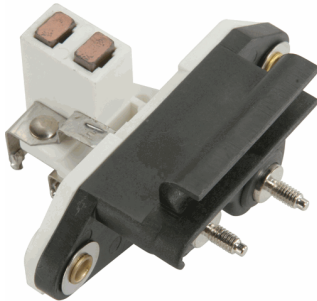

Replaces

BOSCH :
1-194-336-038 5226848

BH-ND01



Replaces

DENSO :

021620-2180 021620-2630

BH-ND03

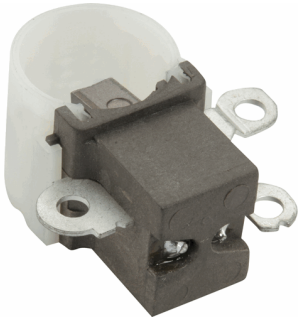

Replaces

DENSO :

021620-2430

BH-ND06

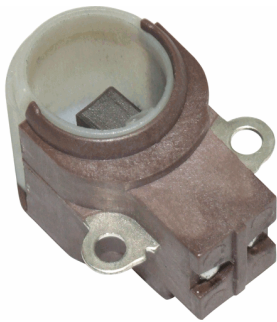

Unit no.

DENSO

104210-3512

FORD

3M5T-10300PC

BH-ND08

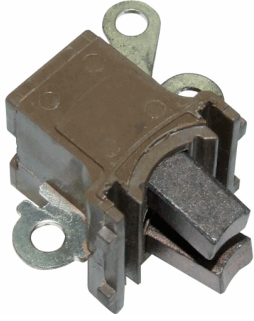

Unit no. [redacted]
HYUNDAI
37300-3C170

BH-ND10



Replaces [redacted]
DENSO :
021620-2720
TOYOTA :
27370-42010

Unit no. [redacted]
DENSO
100211-6030 100211-6031 100211-6050 100211-6051

BH-ND11

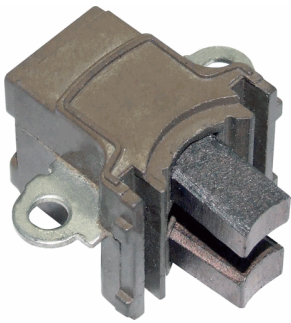

Replaces [redacted]
DENSO :
021620-3001

Unit no. [redacted]
DENSO
421000-0030 421000-0021 421000-0022 421000-0023 421000-0024 421000-0025
421000-0026 421000-0027 421000-0028

BH-ND12



Unit no.

DENSO

104210-205	104210-208	104210-209	104210-289	104210-420	104210-422
104210-423	104210-442	104210-447	104210-454	104210-470	104210-492
104210-551	104210-563	104210-616	421000-022	421000-023	421000-038
104210-6101					

FORD

7C3T-10300EE

BH-H01



Replaces

HITACHI :
L170G-2330

Unit no.

HITACHI

LR170-501C	LR170-502B	LR170-502C	LR170-503	LR170-504	LR170-504B
LR170-504C	LR170-505E	LR170-511	LR170-511B	LR170-512B	LR170-512C

BH-H02

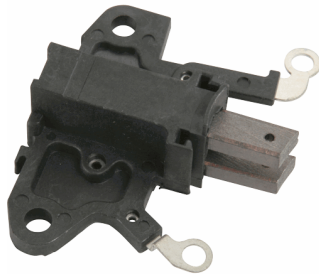

Unit no.

HITACHI

LR1100-704B	LR1100-709	LR160-727	LR170-745	LR170-748	LR170-748B
LR180-741H	LR180-744	LR180-751	LR190-729		

BH-M01



Unit no.

CHRYSLER

4661998

4671041

4686106

4793189

4793190

MITSUBISHI

A2T81192

A2T81292

A2T81391

TB-B001

*Terminal Block

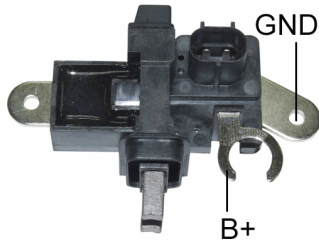

Replaces

BOSCH :

6-004-MR0-000 F-00M-145-250 F-00M-145-426 F-00M-145-477

Unit no.

BOSCH

0-124-425-001	0-124-515-084	0-124-515-115	0-124-525-002	0-124-525-003	0-124-525-004
0-124-525-005	0-124-525-007	0-124-615-018	0-124-615-032	6-004-MA5-001	6-004-ML0-001
6-004-ML0-002	6-004-ML0-004	6-004-ML0-005			

CHRYSLER

56028237	56028237AB	56028238	56028238AB	56028239	56028239AB
56028241	56028560AA	56041120AC	56041322	56041322AB	

VR-B026

*Soft Start
 *8.5 sec. LRC
 *Short Circuit Protection
 *Voltage Set Point: 14.5V

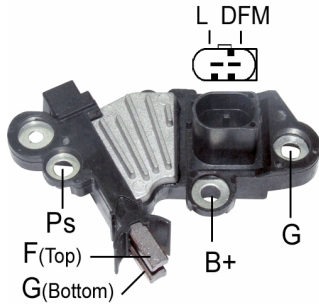

Replaces

BOSCH :

F-00M-346-010 F-00M-346-015 F-00M-346-026 F-00M-346-087

Unit no.

BOSCH

0-121-615-001 0-121-615-002 0-121-615-003

FORD

6C1T-10300AA 6C1T-10300AB 6C1T-10300AC

VR-B029

Replaces

BOSCH :

F-00M-346-029 F-00M-346-053 F-00M-346-136

Unit no.

BOSCH

0-121-615-013 0-121-615-029 0-121-715-004

VR-B033

*BSS Connections

Replaces**BMW :**

12317551254 12317551256 12317561924 12317561939

BOSCH :

F-00M-346-013 F-00M-346-024 F-00M-346-033 F-00M-346-089

Unit no.**BMW**12317542351 12317550469 12317551254 12317551256 12317551256 12317555926
12317557789 12317558219 12317558220 12317560985 12317560986 12317582699**BOSCH**0-121-715-012 0-121-715-016 0-121-715-017 0-121-715-018 0-121-715-112 0-121-715-116
0-121-715-118**Used On****BMW**128i 3.0L 2008-2010
323i 2.5L 2007-2009
328i 3.0L 2007-2010
330Ci 3.0L 2007-2008
528i 3.0L 2008-2010
X3 3.0L 2007-2010
X5 3.0L 2007-2008**VR-B056**

*Voltage Set Point: 13.8V

* LIN-1

* 9600 Baud Rate (4 Byte)

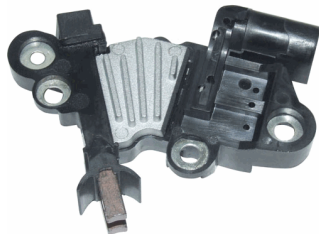
**Replaces****BOSCH :**

F-00M-346-005 F-00M-346-019 F-00M-346-056

VOLVO :

300667453 300667454

Unit no.**BOSCH**0-120-000-003 0-120-000-029 0-121-615-005 0-121-615-006 0-121-615-007 0-121-615-008
0-121-615-009 0-121-615-014 0-121-615-021 0-121-615-028 0-121-715-002 0-121-715-008
0-121-715-024 0-121-715-032**Used On****FORD**Mondeo 2.2L DSL 2008-
Galaxy 2.0L TDCi 2006-**VOLVO**XC90 4.4L 2005-2008
S80 4.4L 2006-2007

VR-B100

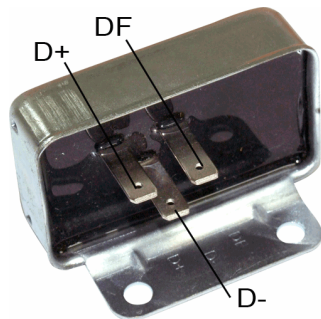

*24V
 *Inactive Lamp
 *Voltage Set Point:28.0V

Replaces

BOSCH :
 9-190-085-000

Unit no.

BOSCH					
9-120-080-039	9-120-080-049	9-120-080-055	9-120-080-058	9-120-080-064	9-120-080-067
9-120-080-069	9-120-080-073	9-120-080-075	9-120-080-085	9-120-080-094	9-120-080-103
9-120-080-104	9-120-080-105	9-120-080-106	9-120-080-113	9-120-080-146	9-120-080-150

VR-B101

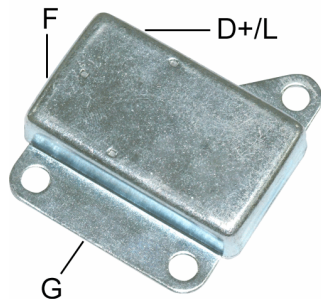

*Inactive Lamp
 *Voltage Set Point: 14.0V

Replaces

BOSCH :
 9-190-087-003

Unit no.

BOSCH					
9-120-080-041	9-120-080-061	9-120-080-072	9-120-080-090	9-120-080-122	F-000-LD0-108

VR-B102

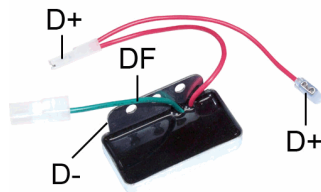

*B-Circuit
 *Inactive Lamp
 *Voltage Set Point:14.2V

Replaces

BOSCH :
 9-190-457-007
VOLKSWAGEN :
 0409038032

Unit no.

BOSCH
 9-120-450-998

VR-B103

*Voltage Set Point: 14.0V

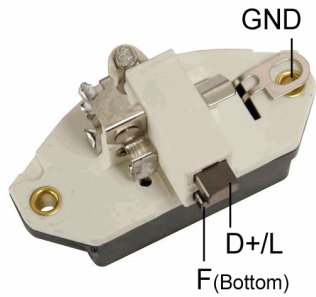

Replaces

BOSCH :

9-190-087-026 9-190-087-032

Unit no.

BOSCH

0-120-484-011	0-120-484-205	9-120-080-153	9-120-080-165	9-120-080-168	9-120-080-169
9-120-080-170	9-120-080-171	9-120-080-172	9-120-080-173	9-120-080-180	9-120-080-198
9-120-080-203	9-120-080-208	9-120-080-211	9-120-080-213		

VR-B104

*Voltage Set Point: 14.2V

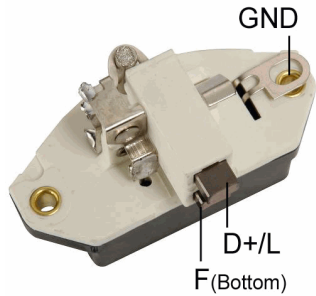

Replaces

BOSCH :

9-190-087-028

Unit no.

BOSCH

9-120-080-161	9-120-080-163	9-120-080-164	9-120-080-167	9-120-080-175	9-120-080-176
9-120-080-177	9-120-080-178	9-120-080-179	9-120-080-185	9-120-080-186	9-120-080-190
9-120-080-191	9-120-080-192	9-120-080-193	9-120-080-194		

VR-B137

- * Soft Start
- * 8.5 sec. LRC
- * Short Circuit Protection
- * Voltage Set Point: 14.5V

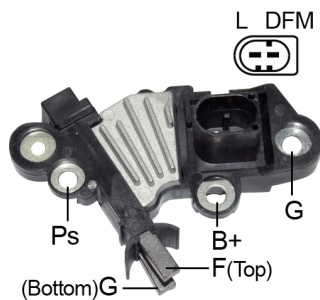

Replaces

BOSCH :

F-00M-346-137

Unit no.

BOSCH

0-121-715-003

VR-B160

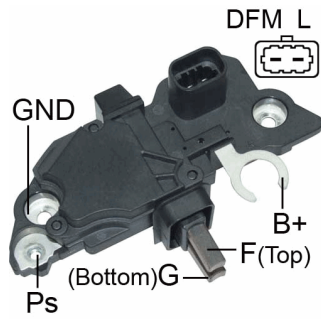

- *Soft Start
- *8.5 sec. LRC
- *Short Circuit Protection
- *Voltage Set Point: 14.5V

Replaces

BOSCH :

F00M144109 F00M144160

Unit no.

BOSCH

0-124-325-163	0-124-325-171	0-124-325-172	0-124-325-221	0-124-425-050	0-124-425-057
0-124-425-058	0-124-425-059	0-124-425-060	0-124-425-084	0-124-425-085	0-124-425-086
0-124-425-087	0-124-425-096	0-124-425-097			

VR-B190

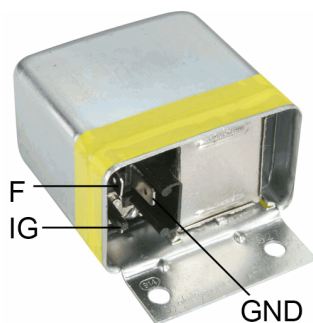

*Mechanic Type
*Voltage Set Point: 14.8V

Replaces

ALFA ROMEO :

530165

AUDI/VW :

021903803A	043903803B	059903803A	21903803	28903803	411903803A
59903803					

BMW :

01244409	1350052	1355456	8708000		
----------	---------	---------	---------	--	--

BOSCH :

0-190-600-001	0-190-600-002	0-190-600-003	0-190-600-004	0-190-600-005	0-190-600-006
0-190-600-007	0-190-600-008	0-190-600-009	0-190-600-010	0-190-600-011	0-190-600-012
0-190-600-013	0-190-600-014	0-190-600-015	0-190-600-016	0-190-600-017	0-190-600-018
0-190-600-020	0-190-600-021	0-190-601-001	0-190-601-002	0-190-601-003	0-190-601-006
0-190-601-007	0-190-601-008	0-190-601-009	0-190-601-010	0-190-601-011	0-190-601-012
0-190-601-013	0-190-601-017	0-190-601-018	0-192-062-001	0-192-062-002	0-192-062-004
0-192-062-005	0-192-062-007	9-190-085-001	9-190-087-011		

FAUN :

1713068

FIAT :

4224467

FORD :

11436766	11444238	11444273			
----------	----------	----------	--	--	--

IHC :

3136411R92	3144046R1				
------------	-----------	--	--	--	--

ISKRA :

11-125-009	11-125-015	11-125-106	AER2901	AER2902	AER3003
------------	------------	------------	---------	---------	---------

JOHN DEERE :

AT31413

KLOCKNER-HUMBOL-DEUTZ :

1160363EF8976	1160363EF8976-1	T1H7615	T4H7615		
---------------	-----------------	---------	---------	--	--

LAMBORGHINI :

29429600

LIEBHERR :

6930211

LUCAS :

21931004	21931013	37697	NCB205	NCB403	
----------	----------	-------	--------	--------	--

MAGIRUS-DEUTZ :

1160363	1160376				
---------	---------	--	--	--	--

MAGNETI MARELLI :

63400006	64800001				
----------	----------	--	--	--	--

MAN :

51256017037	81256010002	81256010003	81256010004	81256010005	81256010021
90801101270					

MASSEY FERGUSON :

1718347M1

MERCEDES-BENZ :

11545106	11546806	11546906	11548406	11548506	1548506
21541506	21542806	21543006	21543606	21547406	

OPEL :

1204226	1204229	1204230	1204231	1204235	1204239
1204254	1204439				

PORSCHE :

90160320301	90160320600	90160320601	90160320602		
-------------	-------------	-------------	-------------	--	--

RENAULT :

5000255685	5000273021	5001001392	7701014809		
------------	------------	------------	------------	--	--

SAAB :

7334634

SCANIA :

VR-B190

229511 263903

SEAT :

HB90600000

SEV MARCHAL :

72160602	72160702	72160902	72210002	72317102	72710502
72711102	72717002	72717202	72717302	72717402	

STEYR :

609F090019 614090017

VALEO :

505043 78700 97163 NC328

VALEO(DUCELLIER) :

510003 519002 8375

VALEO(MOTOROLA) :

9RH7005

VALEO(PARIS RHONE) :

AYC2112 YL414

VOLVO :

01214719	1234519	1308030	241534	241808	241960
246585	248279	530878	531914	588950	6212039

Unit no.**BOSCH**

0-120-400-522	0-120-400-537	0-120-400-607	0-120-400-620	0-120-400-630	0-120-400-654
0-120-400-716	0-120-400-722	0-120-400-726	0-120-400-728	0-120-400-758	0-120-400-764
0-120-400-767	0-120-400-771	0-120-400-803	0-120-400-808	0-120-400-815	0-120-400-840
0-120-400-852	0-120-400-858	0-120-400-869	0-120-400-912	0-120-450-001	

FORD

E8GY-10346-A E8GY-10346-B E9BZ-10346-A

HYUNDAI

37300-21013 37300-21320 37900-21030

MANDO

AR160A

VR-B191

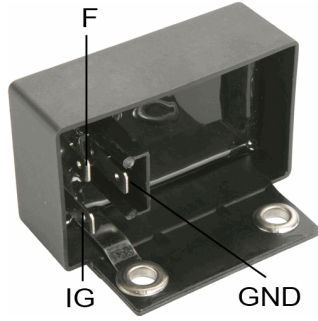

*Electronic Type
*Voltage Set Point: 14.5V

Replaces

ALFA ROMEO :

530165

AUDI/VW :

021903803A 043903803B 059903803A 21903803 28903803 411903803A
59903803

BMW :

01244409 1350052 1355456 8708000

BOSCH :

136325 0190062001 0190062002 0190062004 0190062005 0190062007
0190601011 9190085001 9190087011 0190600001 0190600002 0190600003
0190600004 0190600005 0190600006 0190600007 0190600008 0190600009
0190600010 0190600011 0190600012 0190600013 0190600014 0190600015
0190600016 0190600017 0190600018 0190600020 0190600021 0190601001
0190601002 0190601003 0190601006 0190601007 0190601008 0190601009
0190601010 0190601011 0190601012 0190601013 0190601017 0190601018
0192062001 0192062002 0192062004 0192062005 0192062007 9190085001

FAUN :

1713068

FIAT :

4224467

FORD :

11436766 11444238 11444273

IHC :

3136411R92 3144046R1

ISKRA :

11-125-009 11-125-015 11-125-106 AER2901 AER2902 AER3003

JOHN DEERE :

AT31413

KLOCKNER-HUMBOL-DEUTZ :

1160363EF8976 1160363EF8976-1 T1H7615 T4H7615

LAMBORGHINI :

29429600

LIEBHERR :

6930211

LUCAS :

21931004 21931013 37697 NCB205 NCB403

MAGIRUS-DEUTZ :

1160363 1160376

MAGNETI MARELLI :

63400006 64800001

MAN :

51256017037 8125601002 8125601003 8125601004 8125601005 81256010021
90801101270

MASSEY FERGUSON :

1718347M1

MERCEDES-BENZ :

11545106 11546806 11546906 11548406 11548506 1548506
21541506 21542806 21543006 21543606 21547406

OPEL :

1204226 1204229 1204230 1204231 1204235 1204239
1204254 1204439

PORSCHE :

90160320301 90160320600 90160320601 90160320602

RENAULT :

5000255685 5000273021 5001001392 7701014809

SAAB :

7334634

VR-B191**SCANIA :**

229511 263903

SEAT :

HB90600000

SEV MARCHAL :

72160602	72160702	72160902	72210002	72317102	72710502
72711102	72717002	72717202	72717302	72717402	

STEYR :

609F090019 614090017

VALEO :

505043 78700 97163 NC328

VALEO(DUCELLIER) :

510003 519002 8375

VALEO(MOTOROLA) :

9RH7005

VALEO(PARIS RHONE) :

AYC2112 YL414

VOLVO :

01214719	1234519	1308030	241534	241808	241960
246585	248279	530878	531914	588950	6212039

Unit no.**BOSCH**

0-120-400-522	0-120-400-537	0-120-400-607	0-120-400-620	0-120-400-630	0-120-400-654
0-120-400-716	0-120-400-722	0-120-400-726	0-120-400-728	0-120-400-758	0-120-400-764
0-120-400-767	0-120-400-771	0-120-400-803	0-120-400-808	0-120-400-815	0-120-400-840
0-120-400-852	0-120-400-858	0-120-400-869	0-120-400-912	0-120-450-001	

FORD

E8GY-10346A E8GY-10346B E9BZ-10346A

HYUNDAI

37300-21013 37300-21320 37900-21030

MANDO

AR160A

VR-B192

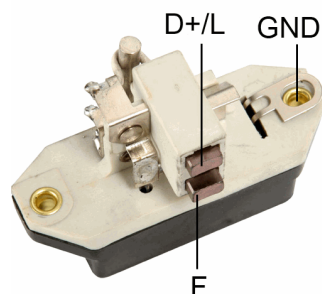

*For 32mm OD slip ring
*Voltage Set Point: 14.7V

Replaces

AUDI/VW :

028903803A	049903803B	049903803E	049903803F	059903803B	059903803C
070903803A	52903803	53903803	63903803		

BOSCH :

0-192-052-001	0-192-052-002	0-192-052-003	0-192-052-004	0-192-052-005	0-192-052-006
0-192-052-008	0-192-052-011	0-192-052-012	0-192-052-013	0-192-052-014	0-192-052-017
0-192-052-018	0-192-052-019	0-192-052-022	0-192-052-026	0-192-052-028	0-192-052-031

FIAT :

4475269	9927829	9934791			
---------	---------	---------	--	--	--

FORD :

1477502	71BB-10316AA				
---------	--------------	--	--	--	--

MAGIRUS-DEUTZ :

42484638					
----------	--	--	--	--	--

MAGNETI MARELLI :

64808010	64808011	64808100	RTT110A	RTT110AB	RTT110ABT
----------	----------	----------	---------	----------	-----------

MERCEDES-BENZ :

21540606	21541806	21542506	21545806		
----------	----------	----------	----------	--	--

OPEL :

1204244					
---------	--	--	--	--	--

VALEO :

505055					
--------	--	--	--	--	--

VALEO(MOTOROLA) :

9RC7062					
---------	--	--	--	--	--

VOLVO :

244332					
--------	--	--	--	--	--

Unit no.

BOSCH

0-120-339-526	0-120-339-527	0-120-339-528	0-120-489-293	0-120-489-309	0-120-489-475
0-120-489-501	0-120-489-519	0-120-489-521	0-120-489-523	0-120-489-532	0-120-489-534
0-120-489-544	0-120-489-550	0-120-489-556	0-120-489-582	0-120-489-587	0-120-489-588
0-120-489-590	0-120-489-602	0-120-489-608	0-120-489-609	0-120-489-610	0-120-489-615
0-120-489-620	0-120-489-621	0-120-489-622	0-120-489-627	0-120-489-628	0-120-489-629
0-120-489-630	0-120-489-641	0-120-489-642	0-120-489-649	0-120-489-650	0-120-489-651
0-120-489-652	0-120-489-655	0-120-489-657	0-120-489-660	0-120-489-683	0-120-489-685
0-120-489-686	0-120-489-687	0-120-489-711	0-120-489-712	0-120-489-735	0-120-489-742
0-120-489-751	0-120-489-775	0-120-489-818	0-120-489-819	0-120-489-822	0-120-489-826
0-120-489-830	0-120-489-832	0-120-489-834	0-120-489-835	0-120-489-843	0-120-489-860
0-120-489-864	0-120-489-867	0-120-489-874	0-120-489-875	0-120-489-876	0-120-489-877
0-120-489-897	0-120-489-898	0-120-489-955	0-120-489-957	9-120-143-216	

VR-B193M

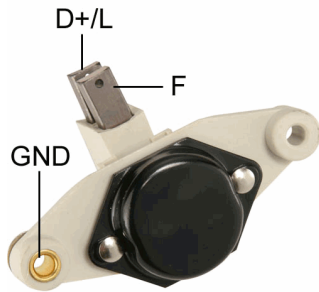

- *VR-B193M:V Setting 14.7V
- *VR-B193ML:V Setting 14.2V
- *VR-B193MA:V Setting 15.0V
- *VR-B193MH:Heavy duty;V Setting 14.7V
- *For 32mm OD slip ring

Replaces

ALFA ROMEO :

7001656

BMW :

12311268073 12311268387 12311286073 12311710732

BOMAG :

5710950 5710957

BOSCH :

0192052003 0192052018 2197311090 1197311000 1197311001 1197311002

1197311090

DELCO :

9009353

DELCO REMY (LUCAS) :

21221347

FENDT :

K830060011010

FIAT :

42490291 4474755 4731653 82302913 9933186 9936532

9940343 9950085

FORD :

5011364 6036646 6057627 74GB-10316AA 78GB-10316AA 81DB-110316AA

A830X-10316FA

GM :

90009353

IHC :

3079037R91 3079123R91

ISKRA :

10-120-110 11-125-003 11-125-040 11-125-049 11-125-073 11-125-117

11-125-121 AER1503 AER1527 AER7201 AER7207 NRE121301

JOHN DEERE :

AL36101 AZ24490

KLOCKNER-HUMBOL-DEUTZ :

1173068 1177496 1306557 1320407 8122153

LAMBORGHINI :

294295100 294390903 296195100

LUCAS :

1221152 21221347 21221373 21221411 21931009 UCB400

UCB412

MAGNETI MARELLI :

64808012 64808109

MAN :

81256016020

MASSEY FERGUSON :

3188023M1

MERCEDES-BENZ :

21543206

OPEL :

1204246 1204252

SAAB :

8558306 8559577 8581779

SEAT :

3894469 3899291 NG98102329

STEYR :

30800090740 61000090742

VALEO :

505-055 NB411

VR-B193M

Unit no.

BOSCH

0-120-339-515	0-120-339-516	0-120-339-521	0-120-339-531	0-120-469-501	0-120-469-502
0-120-469-503	0-120-469-504	0-120-469-505	0-120-469-513	0-120-469-514	0-120-469-515
0-120-469-524	0-120-469-525	0-120-469-528	0-120-469-533	0-120-469-538	0-120-469-539
0-120-489-050	0-120-489-500	0-120-489-508	0-120-489-509	0-120-489-510	0-120-489-511
0-120-489-520	0-120-489-526	0-120-489-527	0-120-489-535	0-120-489-541	0-120-489-542
0-120-489-546	0-120-489-547	0-120-489-548	0-120-489-557	0-120-489-558	0-120-489-559
0-120-489-560	0-120-489-561	0-120-489-562	0-120-489-567	0-120-489-568	0-120-489-569
0-120-489-581	0-120-489-592	0-120-489-593	0-120-489-594	0-120-489-595	0-120-489-600
0-120-489-601	0-120-489-606	0-120-489-607	0-120-489-613	0-120-489-614	0-120-489-616
0-120-489-617	0-120-489-618	0-120-489-619	0-120-489-623	0-120-489-624	0-120-489-631
0-120-489-632	0-120-489-646	0-120-489-647	0-120-489-648	0-120-489-653	0-120-489-654
0-120-489-659	0-120-489-664	0-120-489-665	0-120-489-666	0-120-489-667	0-120-489-668
0-120-489-669	0-120-489-670	0-120-489-671	0-120-489-698	0-120-489-699	0-120-489-713
0-120-489-714	0-120-489-715	0-120-489-716	0-120-489-717	0-120-489-718	0-120-489-720
0-120-489-732	0-120-489-743	0-120-489-744	0-120-489-745	0-120-489-746	0-120-489-747
0-120-489-748	0-120-489-749	0-120-489-753	0-120-489-755	0-120-489-758	0-120-489-771
0-120-489-772	0-120-489-774	0-120-489-777	0-120-489-778	0-120-489-782	0-120-489-783
0-120-489-785	0-120-489-786	0-120-489-788	0-120-489-797	0-120-489-798	0-120-489-800
0-120-489-805	0-120-489-806	0-120-489-820	0-120-489-821	0-120-489-823	0-120-489-824
0-120-489-828	0-120-489-841	0-120-489-843	0-120-489-844	0-120-489-849	0-120-489-850
0-120-489-857	0-120-489-858	0-120-489-859	0-120-489-865	0-120-489-866	0-120-489-868
0-120-489-869	0-120-489-870	0-120-489-871	0-120-489-872	0-120-489-873	0-120-489-892
0-120-489-893	0-120-489-896	0-120-489-913	0-120-489-914	0-120-489-915	0-120-489-916
0-120-489-937	0-120-489-938	0-120-489-942	0-120-489-943		

ISKRA

11201068	11201071	11201077	11201078	11201117	11201143
11201146	11201147	11201167	11201220	11201222	AAK1114
AAK1117	AAK1118	AAK1119	AAK1137	AAK1148	AAK1151
AAK1152	AAK1163	AAK1182	AAK1183	AAK1185	

VR-B194

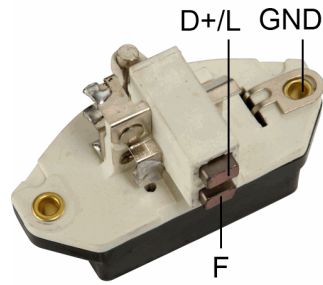

*VR-B194:V Setting 14.7V
 *VR-B194L:V Setting 14.2V
 *For 28mm OD slip ring

Replaces

BOSCH :

0-192-052-015	0-192-052-016	0-192-052-020	0-192-052-021	0-192-052-024	0-192-052-025
0-192-052-027	0-192-052-029	0-192-052-032	0-192-052-035	9-190-067-001	9-190-067-003
9-190-067-005	9-190-067-011				

IHC :

3079412R92

ISKRA :

11-125-094 AER1519

JOHN DEERE :

AL30420 AL35999 AL65077

KLOCKNER-HUMBOL-DEUTZ :

1308784

MERCEDES-BENZ :

21544006

SAAB :

8559585

SCANIA :

280942

VOLVO :

1323467 244489 244612

Unit no.

BOSCH

0-120-468-028	0-120-469-522	0-120-469-532	0-120-469-629	0-120-469-630	0-120-469-687
0-120-469-853	0-120-469-905	0-120-469-956	0-120-484-002	0-120-484-003	0-120-484-017
0-120-488-218	0-120-489-032	0-120-489-156	0-120-489-317	0-120-489-387	0-120-489-658
0-120-489-703	0-120-489-704	0-120-489-708	0-120-489-709	0-120-489-723	0-120-489-724
0-120-489-725	0-120-489-726	0-120-489-729	0-120-489-737	0-120-489-757	0-120-489-779
0-120-489-891	0-120-489-900	0-120-489-902	0-120-489-995	0-120-489-996	9-120-060-910

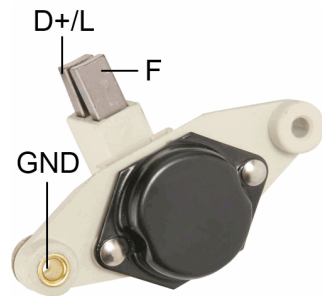
VR-B195M

*V setting 14.7V
 *VR-B195ML:V setting 14.2V
 *VR-B195MA:V setting 15.0V
 *VR-B195MH:Heavy duty;V setting 14.7V
 *For 28mm OD slip ring

Replaces**AUDI/VW :**

068903803B	068903803D	68903803	J2700004010
------------	------------	----------	-------------

BMW :

12311726002

BOSCH :

1-197-311-004	1-197-311-005	1-197-311-006	1-197-311-010	1-197-311-011	1-197-311-012
1-197-311-013	1-197-311-021	1-197-311-024	1-197-311-028	9-191-337-303	

DELCO REMY (LUCAS) :

21221432

FIAT :

60743997	60751439	9938171	9942848	9942885	9960176
----------	----------	---------	---------	---------	---------

FORD :

1640169	6113735	82BB-10316AA	E5RD-10316BA
---------	---------	--------------	--------------

GM :

90349704	90349907
----------	----------

KLOCKNER-HUMBOL-DEUTZ :

1318548	8121111
---------	---------

LUCAS :

21221349	UCB403
----------	--------

OPEL :

1204253	1204256	1204259	90007041	90349704
---------	---------	---------	----------	----------

PORSCHE :

92860315300	94460314100	94460314101
-------------	-------------	-------------

SEAT :

3899919

VR-B195M

Unit no.

BOSCH

0-120-468-001	0-120-468-002	0-120-468-003	0-120-468-004	0-120-468-005	0-120-468-007
0-120-468-008	0-120-468-013	0-120-468-014	0-120-468-017	0-120-468-018	0-120-468-019
0-120-468-020	0-120-468-022	0-120-468-023	0-120-468-025	0-120-468-026	0-120-468-027
0-120-468-029	0-120-468-030	0-120-468-031	0-120-468-032	0-120-468-033	0-120-468-042
0-120-468-043	0-120-468-050	0-120-468-051	0-120-468-052	0-120-468-056	0-120-468-062
0-120-468-064	0-120-468-067	0-120-468-068	0-120-468-074	0-120-468-102	0-120-468-103
0-120-469-541	0-120-469-542	0-120-469-545	0-120-469-546	0-120-469-548	0-120-469-551
0-120-469-552	0-120-469-553	0-120-469-554	0-120-469-556	0-120-469-558	0-120-469-559
0-120-469-560	0-120-469-561	0-120-469-566	0-120-469-581	0-120-469-582	0-120-469-586
0-120-469-588	0-120-469-593	0-120-469-594	0-120-469-595	0-120-469-600	0-120-469-603
0-120-469-604	0-120-469-606	0-120-469-607	0-120-469-610	0-120-469-617	0-120-469-618
0-120-469-619	0-120-469-621	0-120-469-622	0-120-469-623	0-120-469-624	0-120-469-631
0-120-469-632	0-120-469-633	0-120-469-636	0-120-469-637	0-120-469-638	0-120-469-648
0-120-469-649	0-120-469-661	0-120-469-662	0-120-469-671	0-120-469-672	0-120-469-674
0-120-469-675	0-120-469-689	0-120-469-690	0-120-469-696	0-120-469-697	0-120-469-698
0-120-469-700	0-120-469-701	0-120-469-702	0-120-469-705	0-120-469-706	0-120-469-707
0-120-469-708	0-120-469-709	0-120-469-711	0-120-469-712	0-120-469-721	0-120-469-727
0-120-469-728	0-120-469-729	0-120-469-731	0-120-469-732	0-120-469-733	0-120-469-734
0-120-469-735	0-120-469-739	0-120-469-740	0-120-469-741	0-120-469-742	0-120-469-743
0-120-469-749	0-120-469-754	0-120-469-757	0-120-469-758	0-120-469-759	0-120-469-768
0-120-469-775	0-120-469-776	0-120-469-777	0-120-469-778	0-120-469-779	0-120-469-782
0-120-469-783	0-120-469-800	0-120-469-802	0-120-469-804	0-120-469-805	0-120-469-808
0-120-469-809	0-120-469-810	0-120-469-822	0-120-469-823	0-120-469-831	0-120-469-839
0-120-469-845	0-120-469-846	0-120-469-864	0-120-469-865	0-120-469-868	0-120-469-869
0-120-469-902	0-120-469-903	0-120-469-910	0-120-469-914	0-120-469-918	0-120-469-919
0-120-469-922	0-120-469-924	0-120-469-953	0-120-469-975	0-120-469-976	0-120-469-977
0-120-469-985	0-120-484-004	0-120-484-005	0-120-484-006	0-120-484-008	0-120-484-009
0-120-484-010	0-120-484-012	0-120-484-013	0-120-484-014	0-120-484-157	0-120-484-159
0-120-484-161	0-120-484-165	0-120-484-167	0-120-484-169	0-120-484-171	0-120-484-173
0-120-484-175	0-120-484-191	0-120-484-193	0-120-484-201	0-120-484-203	0-120-484-204
0-120-488-102	0-120-488-103	0-120-488-119	0-120-488-163	0-120-488-167	0-120-488-169
0-120-488-171	0-120-488-202	0-120-488-219	0-120-489-002	0-120-489-003	0-120-489-004
0-120-489-005	0-120-489-006	0-120-489-007	0-120-489-008	0-120-489-009	0-120-489-010
0-120-489-011	0-120-489-014	0-120-489-015	0-120-489-017	0-120-489-028	0-120-489-029
0-120-489-030	0-120-489-031	0-120-489-036	0-120-489-037	0-120-489-038	0-120-489-040
0-120-489-041	0-120-489-042	0-120-489-072	0-120-489-073	0-120-489-076	0-120-489-080
0-120-489-081	0-120-489-090	0-120-489-091	0-120-489-094	0-120-489-104	0-120-489-105
0-120-489-115	0-120-489-128	0-120-489-129	0-120-489-130	0-120-489-131	0-120-489-133
0-120-489-134	0-120-489-152	0-120-489-153	0-120-489-167	0-120-489-170	0-120-489-171
0-120-489-195	0-120-489-196	0-120-489-197	0-120-489-200	0-120-489-205	0-120-489-207
0-120-489-208	0-120-489-209	0-120-489-210	0-120-489-211	0-120-489-228	0-120-489-229
0-120-489-237	0-120-489-244	0-120-489-248	0-120-489-249	0-120-489-282	0-120-489-283
0-120-489-287	0-120-489-296	0-120-489-360	0-120-489-361	0-120-489-362	0-120-489-363
0-120-489-364	0-120-489-365	0-120-489-367	0-120-489-369	0-120-489-370	0-120-489-377
0-120-489-378	0-120-489-379	0-120-489-382	0-120-489-386	0-120-489-418	0-120-489-420
0-120-489-421	0-120-489-423	0-120-489-434	0-120-489-448	0-120-489-455	0-120-489-480
0-120-489-483	0-120-489-484	0-120-489-549	0-120-489-888	0-120-489-889	0-120-489-903
0-120-489-904	0-120-489-905	0-120-489-906	0-120-489-961	0-120-489-966	0-120-489-967
0-120-489-968	0-120-489-976	0-120-489-980	0-120-489-981	0-120-489-982	0-120-489-983
0-120-489-986	0-120-489-987	0-120-489-992	0-120-489-993		

VR-B196M

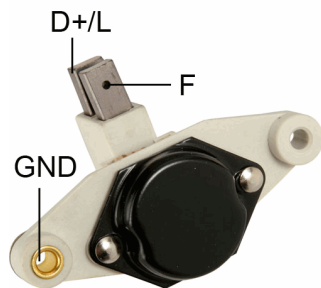

*With Resistor
 *For 28mm OD slip ring
 *VR-B196M:V Setting 14.7V
 *VR-B196ML:V Setting 14.2V

Replaces

BMW :

12311279548 12321271644 12321711399 1711391

BOSCH :

1197311003 1197311007 1197311009 1197311018 1197311023 1197311039
 1197311008 1197311022 1197311035 1197311800 2197311022 137127
 2197311008

DELCO REMY (LUCAS) :

21221416

FERRARI :

0121840

FIAT :

60743883

FORD :

86GB10316AA

LUCAS :

21221412 UCB413 21221416

MERCEDES-BENZ :

21544106 21545106 21547206

PEUGEOT :

5761.47 5761.59

SAAB :

8559619 8571846

SEAT :

3980592

Unit no.

BOSCH

0-120-468-009	0-120-468-010	0-120-468-011	0-120-468-015	0-120-468-016	0-120-468-035
0-120-468-036	0-120-468-045	0-120-468-046	0-120-468-059	0-120-469-543	0-120-469-544
0-120-469-545	0-120-469-547	0-120-469-555	0-120-469-557	0-120-469-563	0-120-469-564
0-120-469-567	0-120-469-568	0-120-469-583	0-120-469-584	0-120-469-589	0-120-469-608
0-120-469-609	0-120-469-611	0-120-469-620	0-120-469-644	0-120-469-645	0-120-469-664
0-120-469-665	0-120-469-668	0-120-469-669	0-120-469-670	0-120-469-680	0-120-469-681
0-120-469-682	0-120-469-683	0-120-469-684	0-120-469-685	0-120-469-744	0-120-469-745
0-120-469-785	0-120-469-786	0-120-469-787	0-120-469-793	0-120-469-811	0-120-469-812
0-120-469-881	0-120-469-882	0-120-469-896	0-120-469-897	0-120-469-927	0-120-469-928
0-120-469-935	0-120-469-992	0-120-469-993	0-120-488-120	0-120-488-121	0-120-488-122
0-120-489-006	0-120-489-025	0-120-489-026	0-120-489-061	0-120-489-064	0-120-489-065
0-120-489-066	0-120-489-069	0-120-489-070	0-120-489-078	0-120-489-079	0-120-489-149
0-120-489-150	0-120-489-183	0-120-489-184	0-120-489-189	0-120-489-190	0-120-489-232
0-120-489-233	0-120-489-234	0-120-489-242	0-120-489-253	0-120-489-254	0-120-489-259
0-120-489-274	0-120-489-275	0-120-489-286	0-120-489-294	0-120-489-325	0-120-489-326
0-120-489-327	0-120-489-328	0-120-489-330	0-120-489-354	0-120-489-355	0-120-489-356
0-120-489-357	0-120-489-358	0-120-489-395	0-120-489-404	0-120-489-405	0-120-489-451
0-120-489-452	0-120-489-881	0-120-489-882	0-120-489-917	0-120-489-918	0-120-489-928
0-120-489-930	0-120-489-932	0-120-489-933	0-120-489-935	0-120-489-936	0-120-489-971
0-120-489-972	0-120-489-974	0-120-489-975	0-120-489-997		

VR-B196MH

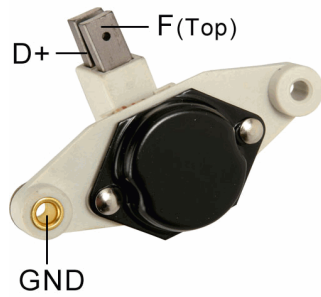

- *For 28mm OD slip ring
- *With 68 ohm Resistor
- *Heavy duty type
- *Voltage Set Point:14.7V

Replaces

AUDI/VW :

34903803

BOSCH :

1-197-311-008	1-197-311-022	1-197-311-026	1-197-311-027	1-197-311-035	1-197-311-038
1-197-311-040	1-197-311-041	1-197-311-050	1-197-311-800		

CITROEN :

9405761558

FORD :

6165056 86GB-10316AA

MERCEDES-BENZ :

21547902 21547906

PEUGEOT :

5761.55

PORSCHE :

96460314100

SAAB :

8590549

VOLVO :

1324617 3523710-6

VR-B197

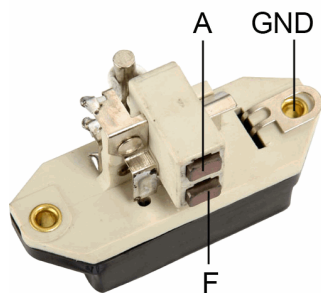

*24V
 *For 32mm OD slip ring
 *Voltage Set Point:28.3V

Replaces

BOSCH :

0-192-053-001 0-192-053-002 0-192-053-004 0-192-053-007 0-192-053-008 0-192-053-027

FIAT :

4701484 79022473 9988935

IHC :

3079147R91

ISKRA :

11-125-004 11-125-055 AER1403 AER1504 AER1507

IVECO :

9988935

KLOCKNER-HUMBOL-DEUTZ :

1306480 4701484 8122154

LUCAS :

21221125 21221348 UCB402

MAGIRUS-DEUTZ :

4701484

MAGNETI MARELLI :

64800007

MAN :

81256016013 81256016017

STEYR :

61500090706

VALEO :

505059 NB412

VALEO(MOTOROLA) :

9RC8090

VOLVO :

244344 244426

Unit no.

BOSCH

0-120-339-537 0-120-339-538 0-120-469-509 0-120-489-481 0-120-489-638 0-120-489-639

0-120-489-640 0-120-489-661 0-120-489-682 0-120-489-793 0-120-489-794 0-120-489-795

0-120-489-796 9-120-144-101 9-120-144-102 9-120-144-103 9-120-144-104 9-120-144-105

9-120-144-106 9-120-144-107 9-120-144-109 9-120-144-110

VR-B198

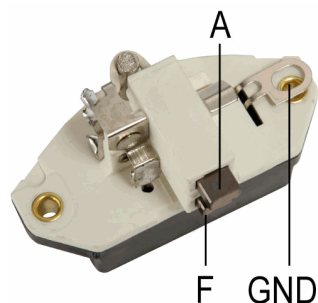

*24V
 *For 28mm OD slip ring
 *Voltage Set Point:28.3V

Replaces

BOSCH :

0192053005	0192053006	0192053011	0192053013	0192053016	0192053017
0192053018	0192053019	0192053022	0192053023		

DELCO REMY (LUCAS) :

21221350

FORD :

6094906

IHC :

3079392R91

ISKRA :

11-125-095 AER1520

IVECO :

79078923

KLOCKNER-HUMBOL-DEUTZ :

1171370 8122152

LIEBHRR :

5004185 5603582

LUCAS :

21931011 UCB404

MAN :

81256016014 81256016016 81256016023 81256016024 81256016027 81256016031

MERCEDES-BENZ :

21543806 21543906 21544706 21544906 21546406 21546706

21547606

SONACOME :

1117344

STEYR :

61200090707 61500090729

Unit no.

BOSCH

0-120-468-037	0-120-469-518	0-120-469-519	0-120-469-520	0-120-469-521	0-120-469-523
0-120-469-527	0-120-469-549	0-120-469-562	0-120-469-569	0-120-469-580	0-120-469-585
0-120-469-592	0-120-469-653	0-120-469-686	0-120-469-691	0-120-469-753	0-120-469-773
0-120-469-807	0-120-469-843	0-120-469-849	0-120-469-851	0-120-469-855	0-120-469-890
0-120-469-959	0-120-488-125	0-120-488-133	0-120-488-136	0-120-488-137	0-120-488-232
0-120-489-023	0-120-489-033	0-120-489-034	0-120-489-035	0-120-489-053	0-120-489-055
0-120-489-071	0-120-489-221	0-120-489-225	0-120-489-230	0-120-489-231	0-120-489-284
0-120-489-320	0-120-489-412	0-120-489-413	0-120-489-643	0-120-489-684	0-120-489-702
0-120-489-707	0-120-489-727	0-120-489-730	0-120-489-733	0-120-489-885	0-120-623-052
0-120-689-502	0-120-689-504	0-120-689-505	0-120-689-506	0-120-689-507	0-120-689-508
0-120-689-510	0-120-689-511	0-120-689-513	0-120-689-514	0-120-689-516	0-120-689-517
0-120-689-520	0-120-689-521	0-120-689-522	0-120-689-523	0-120-689-525	0-120-689-526
0-120-689-527	0-120-689-528	9-120-144-121	9-120-144-125	9-120-144-130	9-120-144-133

VR-B199-3

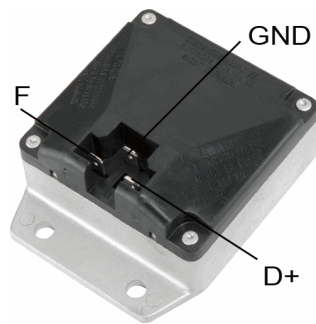

*24V
*Voltage Set Point:28.3V

Replaces

BOSCH :

0-192-033-001 0-192-033-002 0-192-033-004

FORD :

11635831

IHC :

3055449R91 3132862R1

KLOCKNER-HUMBOL-DEUTZ :

114440747 1161178 2404414 B25N92117J N92117T1 S1H7615

LANCIA :

82243312 82294110

LIEBHRR :

6000094 6912707

LUCAS :

21931016 NCB407

MAGNETI MARELLI :

64800004

MAN :

30535010001 51256017029 51256017036 51256017041 51256017046 81256010008
81256010014 81256016007

MASSEY FERGUSON :

2945680M1

MERCEDES-BENZ :

11547006 11548106 11549106 21540506

RENAULT :

7701008802

SCANIA :

225662

STEYR :

610090021

VERSORGUNGS :

2920-12-158-8890

VOLVO :

102746

VOLVO/DAF :

241630 249264 870864

VR-B199-3A

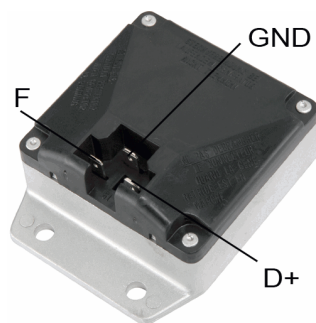

*Voltage Set Point:14.5V

Replaces

BOSCH :

9-190-087-005

VR-B199-4

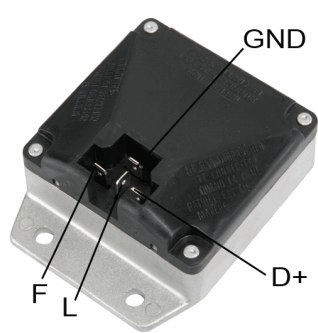

*24V
*Voltage Set Point:28.3V

Replaces

BOSCH :

0-192-033-003 0-192-033-005

FAUN :

1713071

IHC :

3144931R1

KLOCKNER-HUMBOL-DEUTZ :

1162829 2404417 8122110 S4H7615

LANCIA :

82301179

LIEBHRR :

6201558 6912701

LUCAS :

21931015 NCB406

MAGIRUS-DEUTZ :

1162829

MAGNETI MARELLI :

64800005

MAN :

81256010010 81256010011 90801101322

MASSEY FERGUSON :

2868511M91

MERCEDES-BENZ :

11548806 21540206 3505477102

RENAULT :

26563108 7701012214 7701015670

VOLVO/DAF :

4785003

VR-B200H

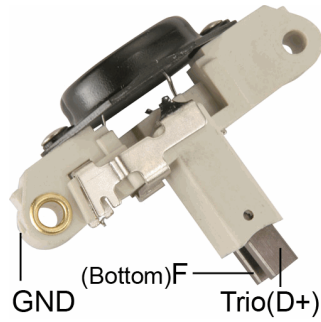

*w/o resistor
 *Heavy Duty
 *Voltage Set Point:14.6V

Replaces

AUDI/VW :

021903803B 028903803B 028903803C 78903803

BOSCH :

1197311212	1197311223	1197311224	1197311225	1197311227	1197311236
1197311238	1197311175	1197311277	1197311548	1127311527	1197311527
1197311540	1197311214	1197311220	1197311221	1197311222	1197311228
1197311229	1197311232	1197311233	1197311235	1197311237	1197311241
1197311519	1197311522	1197311528	1197311521		

DELCO :

90487255

MERCEDES-BENZ :

21548502

NISSAN :

23215-72J00

VALEO :

572587

Unit no.

BOSCH

0-120-465-007	0-120-465-008	0-120-465-010	0-120-465-020	0-120-465-021	0-120-465-028
0-120-465-031	0-120-485-015	0-120-485-018	0-120-485-023	0-120-485-025	0-120-485-026
0-120-485-034	0-120-485-036	0-120-485-038	0-120-485-039	0-120-485-043	0-120-485-044
0-120-485-048	0-120-505-005	0-123-120-001	0-123-214-002	0-123-310-001	0-123-310-002
0-123-315-001	0-123-315-002	0-123-315-003	0-123-315-006	0-123-340-002	0-123-340-003
0-123-340-005	0-123-505-010	0-123-510-001	0-123-510-062		

VR-B201H

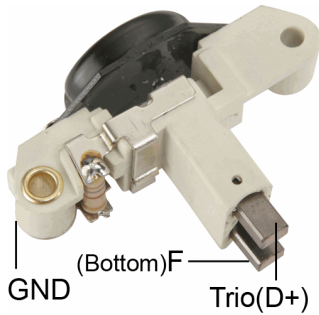

*w/180 ohm resistor
 *Heavy Duty
 *Voltage Set Point:14.6V

Replaces

BOSCH :

1197311211	1197311213	1197311217	1197311219	1197311242	1197311533
1197311556					

MERCEDES-BENZ :

0021548106	0021548206	0021548506	0021548706	0021549206	0022159106
0031540606					

PEUGEOT :

5761.85	5761.86	95644494			
---------	---------	----------	--	--	--

VALEO :

3544570					
---------	--	--	--	--	--

Unit no.

BOSCH

0-120-465-004	0-120-465-006	0-120-465-012	0-120-465-013	0-120-465-014	0-120-465-015
0-120-465-016	0-120-465-017	0-120-485-011	0-120-485-012	0-120-485-022	0-123-213-007
0-123-315-005					

VR-B202

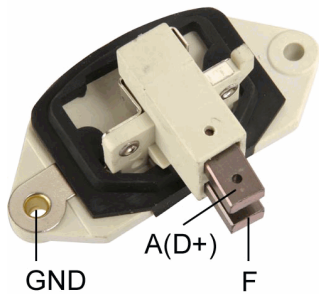

*For 28mm OD slip ring
 *Voltage Set Point:14.7V

Replaces

BOMAG :

5710956					
---------	--	--	--	--	--

BOSCH :

0192052033	0192053032	1197311031	1197311043	2197311026	2197311028
2197311029	9190087020	9190087023	0192052035	1197311029	1197311030
1197311034	1197311045				

KLOCKNER-HUMBOL-DEUTZ :

1173069	1177145	1178644			
---------	---------	---------	--	--	--

MERCEDES-BENZ :

1541805	21543706				
---------	----------	--	--	--	--

Unit no.

BOSCH

0-120-469-526	0-120-469-540	0-120-469-762	0-120-484-001	0-120-484-017	0-120-488-185
0-120-488-209	0-120-489-022	0-120-489-315	0-120-489-710	0-120-489-756	

VR-B202L

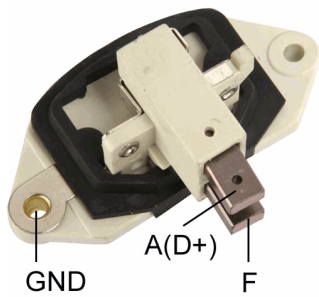

*For 28mm OD slip ring
 *Voltage Set Point: 14.2V
 *Same as VR-B202 but with lower volts setting

VR-B203

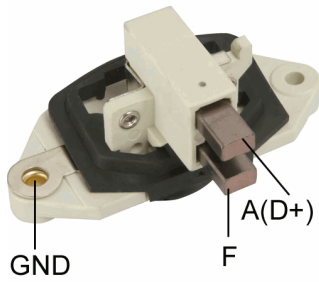

*24V
 *For 28mm OD slip ring
 *Volts setting 28.3V

Replaces

BOSCH :					
1197311300	1197311301	1197311304	0192053011	1197311305	1197311306
1197311307	2197311301	6033RD0002			

KLOCKNER-HUMBOL-DEUTZ :
 1178336

MERCEDES-BENZ :
 1541705 21548406

SCANIA :
 117253 305160 362645

VOLVO :
 1606935 1625880 1698185 3239266 9600908

Unit no.

BOSCH					
0-120-468-053	0-120-468-065	0-120-468-066	0-120-469-518	0-120-469-549	0-120-469-562
0-120-469-569	0-120-469-634	0-120-469-643	0-120-469-673	0-120-469-761	0-120-469-763
0-120-469-797	0-120-469-891	0-120-469-900	0-120-469-920	0-120-469-959	0-120-469-960
0-120-488-153	0-120-488-224	0-120-489-192	0-120-489-303	0-120-489-316	0-120-489-411
0-120-489-643	0-120-489-728	0-120-489-730	0-120-489-731	0-120-489-827	0-120-489-886
0-120-489-944	9-120-144-116	9-120-144-117	9-120-144-119	9-120-144-120	9-120-144-122
9-120-144-123	9-120-144-127	9-120-144-129	9-120-144-131	9-120-144-132	

VR-B204

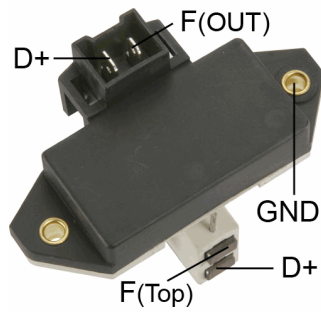

*For 28mm OD slip ring
*Voltage Set Point: 14.7V

Replaces

BOSCH :
0-192-052-023

Unit no.

BOSCH
0-120-489-059 0-120-489-999 9-120-144-219 9-120-144-220 9-120-144-232 9-120-144-233

VR-B205

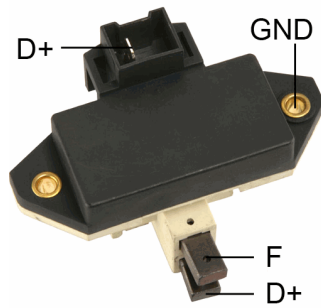

*For 28mm OD slip ring
*Voltage Set Point: 14.7V

Replaces

BOSCH :
0-192-052-030
TALBOT :
43269200

Unit no.

BOSCH
9-120-144-231

VR-B206

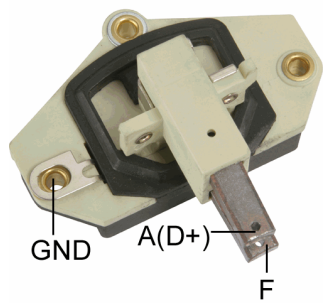

*24V
 *For 28mm OD slip ring
 *Voltage Set Point:28.3V

Replaces

BOSCH :

0-192-053-003 0-192-053-009 0-192-053-012 0-192-053-014 0-192-053-025 1-197-311-315

IVECO :

93157259

KLOCKNER-HUMBOL-DEUTZ :

1320082 1320381 8122275

MAN :

81256016015 81256016021 81256016025 81256016030

MERCEDES-BENZ :

21543506 21545506 21546806

VOLVO :

1698764

Unit no.

BOSCH

0-120-689-503 0-120-689-512 0-120-689-515

VR-B207

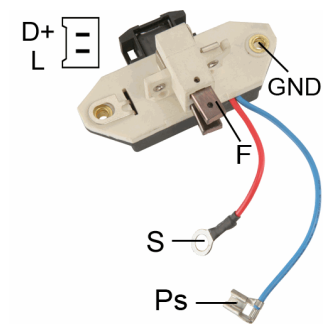

*For 28mm OD slip ring
 *Voltage Set Point:14.7V

Replaces

BOSCH :

9-191-337-302 9-191-337-306

Unit no.

BOSCH

9-120-144-257 9-120-144-258 9-120-144-260 9-120-144-262 9-120-144-264 9-120-144-267
 9-120-144-268 9-120-144-272 9-120-144-274 9-120-144-276 9-120-144-278 9-120-144-284
 9-120-144-286 9-120-144-298 9-120-144-303

VR-B208H

*Same as VR-B201H except with 68 Ohm Resistor
 *Voltage Set Point: 14.6V

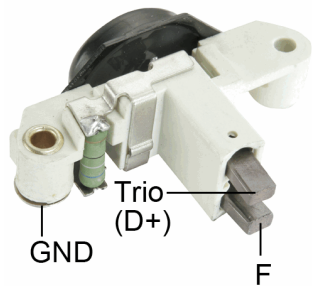

Replaces

BOSCH :

1-197-311-234 1-197-311-239 1-197-311-514

Unit no.

BOSCH

0-120-465-006 0-123-510-017 0-123-545-003

VR-B209

*24V
 *Same as VR-B203 but with higher volts setting(28.5V)

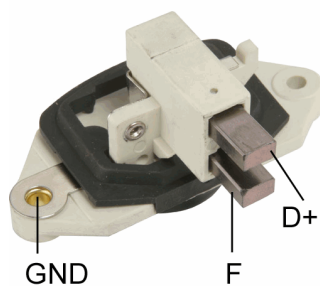

Replaces

BOSCH :

1197311304 1197311324 6033RD2006

MERCEDES-BENZ :

21548406

SCANIA :

117253 362645

VOLVO :

1606935 1625880

Unit no.

BOSCH

0-120-468-065	0-120-468-066	0-120-468-093	0-120-468-094	0-120-468-114	0-120-468-116
0-120-468-118	0-120-468-124	0-120-468-129	0-120-468-130	0-120-469-010	0-120-469-014
0-120-469-018	0-120-469-022	0-120-469-023	0-120-469-031	0-120-469-523	0-120-469-549
0-120-469-569	0-120-469-673	0-120-469-679	0-120-469-763	0-120-469-798	0-120-469-900
0-120-469-959	0-120-469-960	0-120-469-978	0-120-469-999		

VR-B210

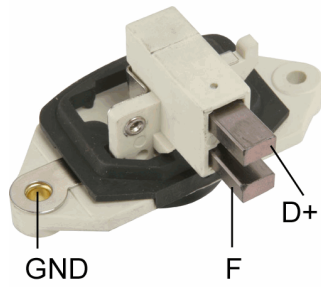

*24V
 *Same as VR-B203 but with higher volts setting(29.0V)

Replaces

BOSCH :
 1-197-311-309

Unit no.

BOSCH					
0-120-468-053	0-120-468-065	0-120-468-066	0-120-469-518	0-120-469-549	0-120-469-562
0-120-469-569	0-120-469-634	0-120-469-643	0-120-469-673	0-120-469-761	0-120-469-763
0-120-469-797	0-120-469-891	0-120-469-900	0-120-469-920	0-120-469-959	0-120-469-960
0-120-488-153	0-120-488-224	0-120-489-192	0-120-489-303	0-120-489-316	0-120-489-411
0-120-489-643	0-120-489-728	0-120-489-730	0-120-489-731	0-120-489-827	0-120-489-886
0-120-489-944	9-120-144-116	9-120-144-117	9-120-144-119	9-120-144-120	9-120-144-122
9-120-144-123	9-120-144-127	9-120-144-129	9-120-144-131	9-120-144-132	

VR-B211

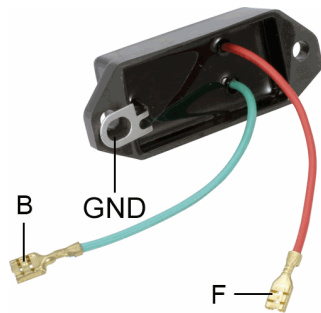

*Voltage Set Point:14.2V

Replaces

BOSCH :
 9-121-080-303 9-190-087-003
VW/BRAZIL :
 409038031

Unit no.

BOSCH			
9-120-080-061	9-120-080-072	9-120-080-090	9-120-080-122

VR-B212

*Voltage Set Point:14.7V

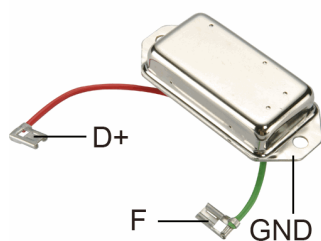

Replaces

BOSCH :

9-190-457-006

Unit no.

BOSCH

9-120-450-044	9-120-450-071	9-120-450-077	9-120-450-085	9-120-450-090	9-120-450-092
9-120-450-100	9-120-450-102	9-120-450-105	9-120-450-107	9-120-450-113	9-120-450-118
9-120-450-119	9-120-450-131				

VR-B213

*Voltage Set Point:14.2V

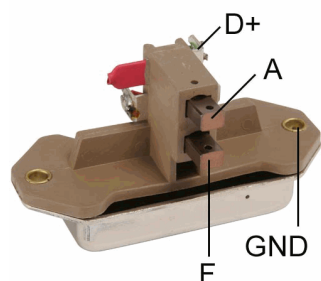

Unit no.

BOSCH

9-120-450-041	9-120-450-043	9-120-450-073	9-120-450-078	9-120-450-084	9-120-450-086
9-120-450-087	9-120-450-088	9-120-450-089	9-120-450-094	9-120-450-096	9-120-450-110
9-120-450-125	9-120-450-126	9-120-450-129	9-120-450-133		

VR-B215

*Electronic Type
*Voltage Set Point:14.5V

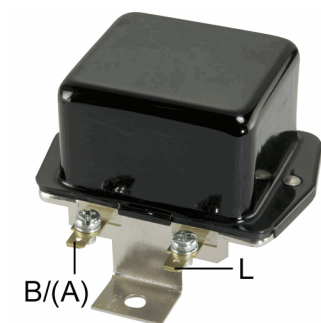

Replaces

BOSCH :

9-190-455-001 9-190-455-009

VR-B217H

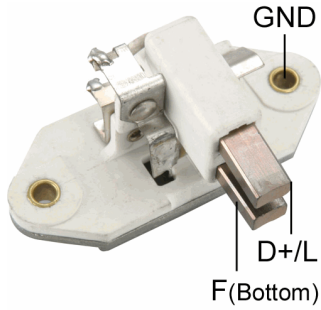

*Heavy Duty
*Voltage Set Point:14.2V

Replaces

BOSCH :
9-190-087-040

VR-B218

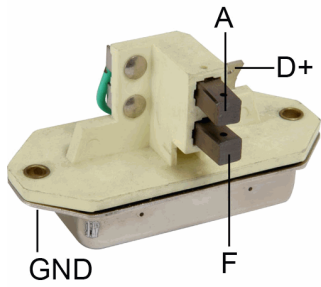

*Voltage Set Point:14.2V

Replaces

BOSCH :
9-190-457-002

Unit no.

BOSCH
9-120-450-006 9-120-450-134 9-120-450-137 9-120-456-024

VR-B219

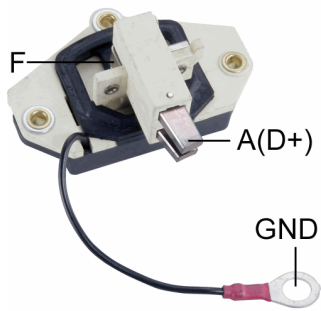

*24V
*For 28mm OD slip ring
*Bus Type Regulator
*Scania Autobus with Mercedes Engine
*Voltage Set Point:28.3V

Replaces

BOSCH :
9190457003 192053021 1197311319 1197311320 9152053021 9190457048

Unit no.

BOSCH
9-120-456-003 9-120-456-014 9-120-456-016 9-120-456-028

VR-B220

*Voltage Set Point:14.7V

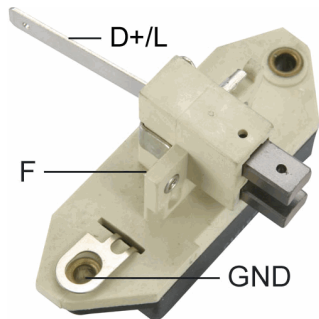

Replaces

BOSCH :

0192052007 1197311047 9191337311 0192052010

LUCAS :

UCB407

MAGNETI MARELLI :

940038005

Unit no.

BOSCH

0-120-489-506 0-120-489-565 0-986-031-120

VR-B221

* L Terminal Drives Choke

*Soft Start

*8.5 sec. LRC

*Voltage Set Point:14.4V

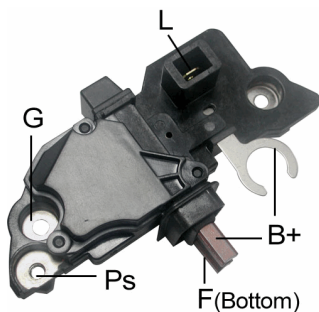

Replaces

BOSCH :

F-00M-145-229

Unit no.

BOSCH

0-124-515-017 0-124-515-054 0-124-525-001 0-124-525-014 0-124-525-029

VOLVO

9442841

VR-B222

*For 14mm OD slip ring
*Voltage Set Point:14.6V

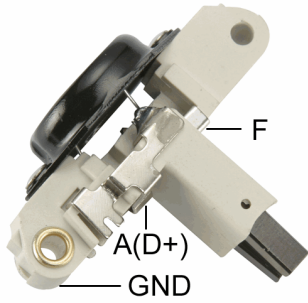

Replaces

AUDI/VW :
028903803D

BOSCH :
1197311500 1197311523 1197311530 1197311531 1197311548

Unit no.

BOSCH
0-123-325-005 0-123-325-006 0-123-505-011 0-123-505-012 0-123-505-013 0-123-510-046
0-123-510-047 0-123-515-014 0-123-515-017 0-123-515-018 0-123-515-020 0-123-515-021

VR-B224B

*24V
*Voltage Set Point:28.3V

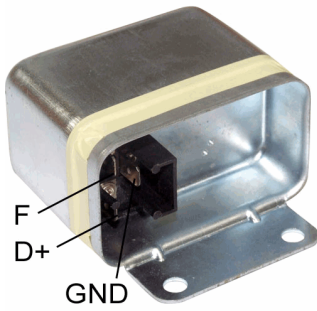

Replaces

BOSCH :
9-190-085-000

Unit no.

BOSCH
9-120-080-039 9-120-080-049 9-120-080-055 9-120-080-058 9-120-080-064 9-120-080-067
9-120-080-069 9-120-080-073 9-120-080-075 9-120-080-085 9-120-080-086 9-120-080-094
9-120-080-103 9-120-080-104 9-120-080-105 9-120-080-106

VR-B225

*For 14mm OD slip ring
*Voltage Set Point:14.7V

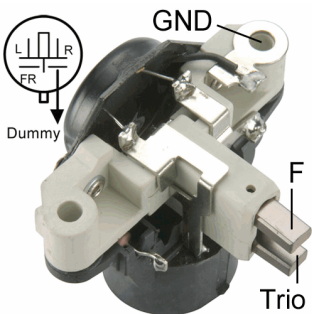

Replaces

BOSCH :
1-119-311-231 1-197-311-231

Unit no.

BOSCH
0-123-315-020 0-123-315-007

VR-B226

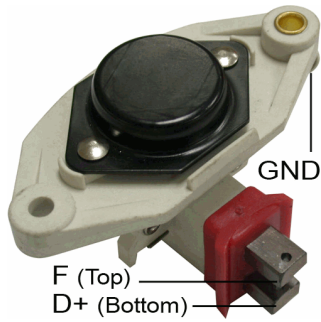

*24V
 *For 28mm OD slip ring
 *Voltage Set Point:28.3V

Replaces

BOSCH :
 9-191-337-310

Unit no.

BOSCH
 0-120-469-103 6033GB3047

VR-B229

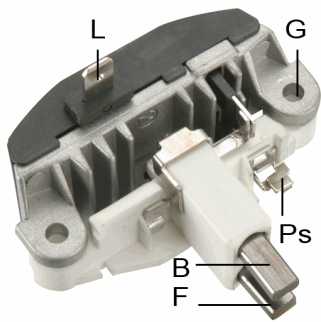

*For 14mm OD slip ring
 *Voltage Set Point:14.2V

Replaces

BOSCH :
 1-197-311-518 1-197-311-520

Unit no.

BOSCH
 0-123-315-016 0-123-315-021 0-123-505-014 0-123-505-015 0-123-505-016

VR-B235

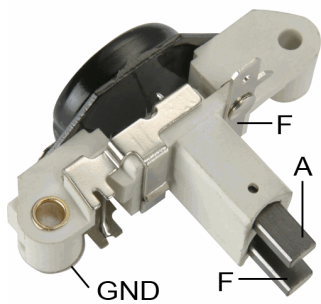

*For 14mm OD slip ring
 *Voltage Set Point:14.6V

Replaces

BOSCH :
 1-197-311-511

Unit no.

BOSCH
 0-123-505-017 0-123-510-007 0-123-510-008 0-123-510-028 0-123-515-003 0-123-515-008
 0-123-515-009 0-123-515-011 0-123-515-012 0-123-515-024 0-123-520-003 0-123-520-004

VR-B238

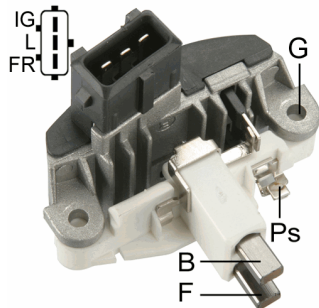

*For 14mm OD slip ring
*Voltage Set Point: 14.5V

Replaces

BOSCH :

1197311545	1197311506	1197311516	1197311536	1197311545	1197311557
------------	------------	------------	------------	------------	------------

Unit no.

BOSCH

0-123-315-013	0-123-325-010	0-123-515-002	0-123-515-004	0-123-515-007	0-123-515-010
0-123-515-022	0-123-515-023	0-123-515-025	0-123-515-030		

VR-B240H

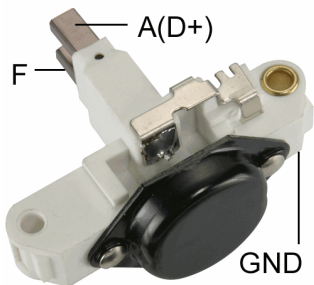

*For 14mm OD slip ring
*Low Cut In Speed
*VR-B240HL(Volts Setting 14.4V)
*Voltage Set Point: 14.6V

Replaces

BOSCH :

1-197-311-240	1-197-311-512	1-197-311-551	1-197-311-552	1-197-311-553
---------------	---------------	---------------	---------------	---------------

Unit no.

BOSCH

0-120-110-007	0-120-335-007	0-120-335-011	0-120-335-012	0-123-310-010	0-123-310-011
0-123-310-012	0-123-310-013	0-123-310-051			

VR-B242

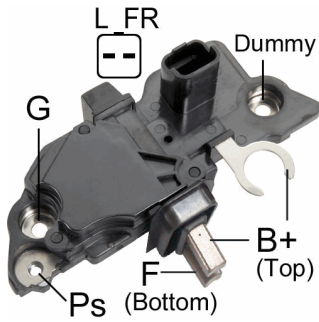

- *A-Circuit
- *Active Lamp
- *Soft Start
- *8 sec. LRC
- *Short Circuit Protection
- *Voltage Set Point:14.5V

Replaces

BOSCH :

F00M141381 F00M145276 F00M145368 F00M144181 F00M145375 F00MA45237

Unit no.

BOSCH

0-124-525-028 0-124-525-043 0-124-525-044 0-124-525-047 0-124-525-070 0-124-525-076
 0-124-525-082

Used On

RENAULT

Megane II(BM0_CM0_) 1.9dCi 2002-

VAUXHALL

Movano Chassis/Cab 2.5 CDTI 2004-
 Movano Combi 2.5 CDTI Bus 74 kW 2004-

VR-B243

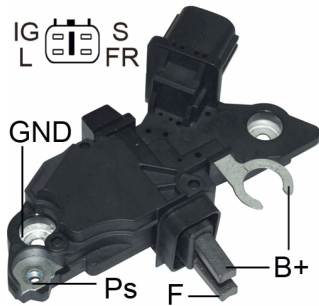

- *A-Circuit
- *Active Lamp
- *Soft Start
- *5.0 sec. LRC
- *Short Circuit Protection
- *Voltage Set Point:14.4V

Replaces

BOSCH :

F00M145236 F00M145305 F00M145324 F00M145376 F00M145865 F00M145873
 F00M145334 F00M145392 F00M145874

TOYOTA :

27700-0L020

Unit no.

BOSCH

0-120-000-023 0-124-315-015 0-124-315-016 0-124-315-024 0-124-315-025 0-124-315-029
 0-124-315-033 0-124-315-034 0-124-315-040 0-124-325-071 0-124-325-079 0-124-325-085
 0-124-325-086 0-124-325-123 0-124-325-165

TOYOTA

27060-0P010

Used On

TOYOTA

TACOMA 4.0 6 Cyl. 2007-2009

VR-B247

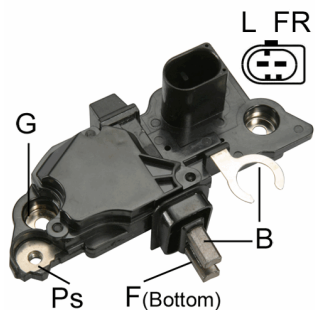

- *A-Circuit
- *Soft Start
- *2.5 sec. LRC
- *Short Circuit Protection
- *Voltage Set Point:14.5V

Replaces

BOSCH :

F-00M-145-247 F-00M-145-357

Unit no.

BOSCH

0-124-325-040 0-124-515-055 0-124-615-012 0-124-515-047

VR-B250

- *Voltage Set Point:14.6V

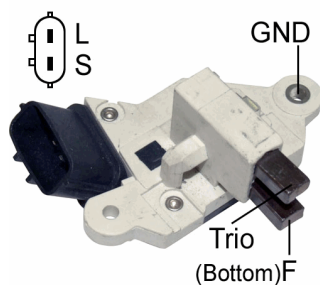

Replaces

BOSCH :

9-190-041-002

VR-B251

- *For 14mm OD slip ring
- *Voltage Set Point:14.5V

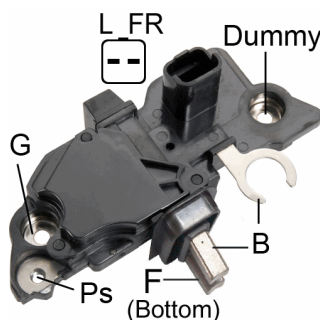

Replaces

BOSCH :

F-00M-145-239 F-00M-A45-234 F-00M-144-111 F-00M-145-387 F-00M-145-388

Unit no.

BOSCH

0-124-325-024 0-124-415-007 0-124-415-013 0-124-415-014

VR-B252

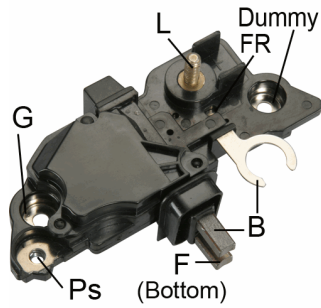

- *For 14mm OD slip ring
- *Soft Start
- *8.5 sec. LRC
- *Short Circuit Protection
- *Voltage Set Point:14.5V

Replaces

BOSCH :

F-00M-145-201	F-00M-145-231	F-00M-144-142	F-00M-145-257	F-00M-145-282	F-00M-145-370
F-00M-144-140	F-00M-145-680	F-00M-145-675	F-00M-145-329	F-00M-144-177	

FIAT :

9949575

MERCEDES-BENZ :

0031541506

OPEL :

1204289	9117942	9201135	93176380
---------	---------	---------	----------

Unit no.

BOSCH

0-124-215-001	0-124-215-003	0-124-225-001	0-124-225-002	0-124-225-004	0-124-225-009
0-124-415-002	0-124-415-005	0-124-415-008	0-124-415-010	0-124-225-001	0-124-225-002
0-124-225-004	0-124-225-009	0-124-225-018	0-124-225-022	0-124-225-023	0-124-225-024
0-124-225-025	0-124-325-023	0-124-325-054	0-124-325-055	0-124-415-001	0-124-415-002
0-124-415-005	0-124-415-008	0-124-415-010	0-124-515-004	0-124-515-005	0-124-515-006
0-124-515-023	0-124-515-031	0-124-515-061	0-124-515-099	0-124-515-100	0-124-525-186
0-124-625-105	0-124-625-123	0-124-625-059			

VR-B253

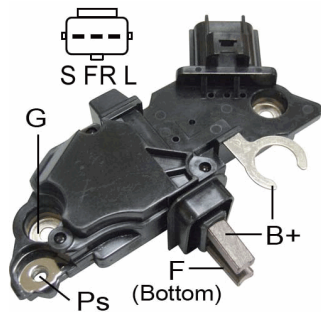

- *Soft Start
- *Short Circuit Protection
- *Voltage Set Point:14.5V

Replaces

BOSCH :

F00M145214	F00M144183	F00M145348
------------	------------	------------

Unit no.

BOSCH

0-124-325-063	0-124-325-064	0-124-415-006
---------------	---------------	---------------

VR-B254

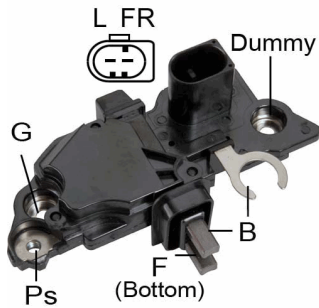

- *For 14mm OD slip ring
- *2.5 Second LRC
- *Soft Start 30%
- *Short Circuit Protection
- *Voltage Set Point:14.5V

Replaces

BOSCH :

F00M145225	F00M144136	F00M144153	F00M144154	F00M145195	F00M145234
F00M145237	F00M145238	F00M145315	F00M145344	F00M145350	F00M145353
F00M145354	F00M145355	F00M145383	F00M145384	F00M145891	F00MA45208
F00MA45232	F00MA45303				

Unit no.

BOSCH

0-124-215-006	0-124-225-012	0-124-315-001	0-124-315-002	0-124-315-003	0-124-315-004
0-124-315-005	0-124-315-006	0-124-315-007	0-124-315-008	0-124-315-011	0-124-315-012
0-124-315-013	0-124-315-018	0-124-315-020			

VR-B255

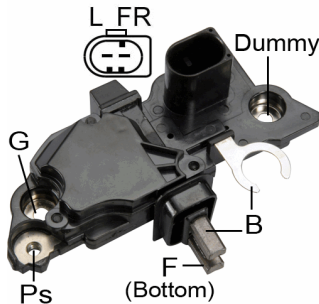

- *For 14mm OD slip ring
- *Soft Start
- *8.5 Second LRC
- *Short Circuit Protection
- *Voltage Set Point:14.5V

Replaces

BOSCH :

F-00M-145-206	F-00M-145-240
---------------	---------------

Unit no.

BOSCH

0-124-325-006	0-124-325-007	0-124-325-010	0-124-325-011	0-124-515-020	0-124-515-021
---------------	---------------	---------------	---------------	---------------	---------------

VR-B256

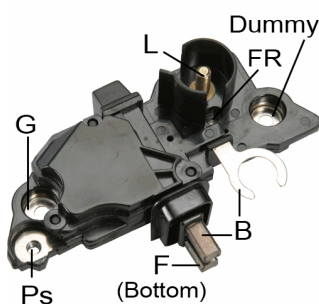

- *For 14mm OD slip ring
- *Soft Start
- *2.5 sec. LRC
- *Short Circuit Protection
- *Voltage Set Point:14.5V

Replaces

BOSCH :

F-00M-145-220	F-00M-145-349
---------------	---------------

Unit no.

BOSCH

0-124-215-001	0-124-215-002	0-124-215-003	0-124-215-005	0-124-225-016	0-124-225-026
0-124-225-027	0-124-325-009	0-124-325-028	0-124-415-011	0-124-415-012	

VR-B257

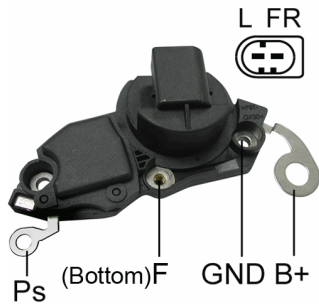

- *Soft Start
- *2.5 Second LRC
- *Short Circuit Protected
- *Voltage Set Point:14.3V

Replaces

BOSCH :

01229AA0X0	F00M225401	F00M225201	F00M225200
------------	------------	------------	------------

Unit no.

BOSCH	0-122-0AA-0B0	0-122-0AA-2A0	0-122-500-076	0-986-041-760
-------	---------------	---------------	---------------	---------------

VR-B259

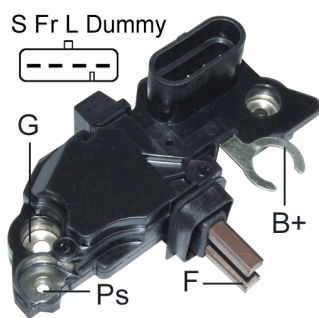

- *Soft Start
- *2.5 sec. LRC
- *Short Circuit Protection
- *Voltage Set Point:14.6V

Replaces

BOSCH :

F-00M-145-224	F-00M-145-241
---------------	---------------

Unit no.

BOSCH	6004MA5008	6004ML0017	6004ML0024
GM	10418888		

VR-B260

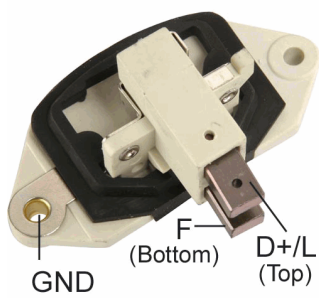

- *For 32mm OD slip ring
- *Voltage Set Point:14.2V

Replaces

BOSCH :

1197311032	1197311033	1197311045	1197311046	2197311032
------------	------------	------------	------------	------------

Unit no.

BOSCH	0-120-484-011	0-120-488-134	0-120-488-138	0-120-488-205	0-120-488-233
-------	---------------	---------------	---------------	---------------	---------------

VR-B261

*Voltage Set Point: 14.4V

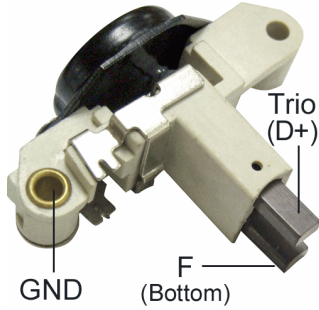

Replaces

BOSCH :
1-197-311-541

Unit no.

BOSCH					
0-123-320-040	0123320046	0123320047	0123320049	0123320051	0123320058
0123320060	0123320061	0123320062	0123340007		

VR-B262

*Active Lamp
*Soft Start
*8.5 sec. LRC
*Short Circuit Protection
*Voltage Set Pont:14.5V

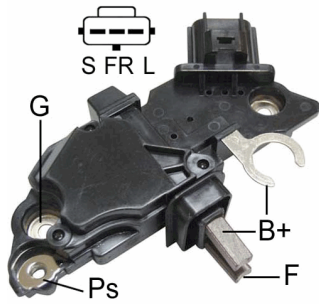

Replaces

BOSCH :
F-00M-145-255

Unit no.

BOSCH					
0-124-315-019	0-124-315-027	0-124-415-016	0-124-415-030	0-124-415-032	0-124-525-021

Used On

FORD

Transit Diesel	2.0 DI 2000 up
Transit Diesel	2.4 DI/TDE/TDCi
Transit Diesel	2.4 DI/TDE/TDCi/TDdi
Transit Diesel	2.0 TDCi 2000 up

VR-B263

*Soft Start
*2.5 Second LRC
*Short Circuit Protected
*Voltage Set Point:14.4V

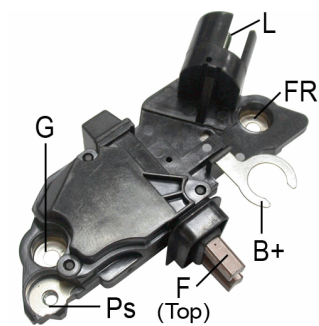

Replaces

BOSCH :
F-00M-145-252

Unit no.

BOSCH	
0-124-615-002	0-124-615-027

VR-B264

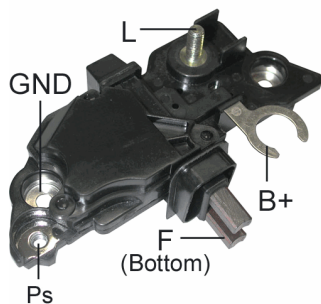

- *A-Circuit
- *Active Lamp
- *Soft Start
- *2.5 sec. LRC
- *Short Circuit Protection
- *Voltage Set Point:14.4V

Replaces

BOSCH :

0-031-542-906 F-00M-145-248 F-00M-145-358

MERCEDES-BENZ :

0031542806 0031545506 0031545606

Unit no.

BOSCH

0-124-325-039	0-124-325-046	0-124-325-093	0-124-325-105	0-124-515-061	0-124-515-064
0-124-515-091	0-124-515-114	0-124-515-118	0-124-525-085	0-124-615-015	0-124-615-019
0-124-615-033	0-124-615-035	0-124-625-020			

CHRYSLER

5134199AA 5134204AA 5134205AA

MERCEDES-BENZ

0121541502	0121542002	0121542402	0121544602	0131541302	0131541502
0131541702					

Used On

DODGE

Freightliner

MERCEDES-BENZ

Sprinter Vans

VR-B265

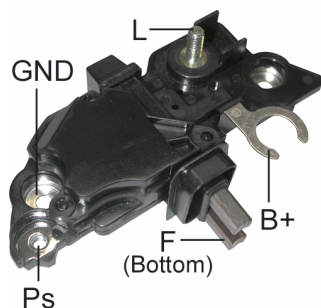

- *Soft Start
- *2.5 sec LRC
- *Short Circuit Protection
- *Voltage Set Point:14.7V

Replaces

BOSCH :

F-00M-145-227

Unit no.

BOSCH

0-124-515-008 0-124-515-043

GM

21019217 22674550 9227893

VR-B266

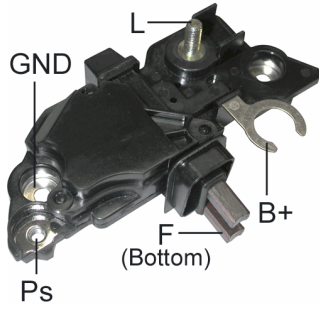

- *Soft Start
- *0.5 Second LRC
- *Short Circuit Protected
- *Voltage Set Point:14.4V

Replaces

BOSCH :

F-00M-145-271 F-00M-145-366

Unit no.

BOSCH

0-124-525-016

VR-B267

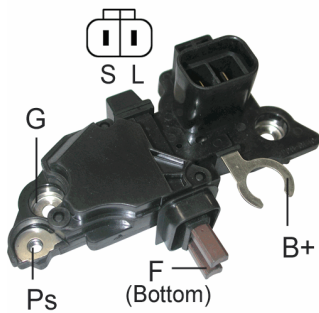

- *Soft Start
- *5 Second LRC
- *Short Circuit Protected
- *Voltage Set Point:14.5V

Replaces

BOSCH :

F-00M-145-207 F-00M-145-347

Unit no.

BOSCH

0-124-325-008 0-124-325-010 0-124-515-041

VR-B268

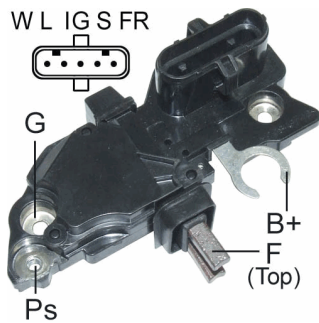

- *Soft Start
- *0.5 Second LRC
- *Short Circuit Protected
- *Loss of Sense Lamp On
- *Voltage Set Point:28.3V

Replaces

BOSCH :

F-00M-144-103 F-00M-144-119 F-00M-145-246 F-00M-145-297 F00M144120

Unit no.

BOSCH

0-124-555-005	0-124-555-009	0-124-555-010	0-124-555-017	0-124-555-020	0-124-555-028
0-124-555-030	0-124-655-005	0-124-655-006	0-124-655-008	0-124-655-012	0-124-655-013
0-124-655-019	0-124-655-030	0-124-655-033			

VR-B269

*Voltage Set Point:14.5V

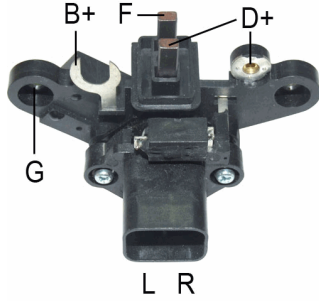

Replaces

BOSCH :
F002G10376079

VR-B270

*Soft Start
*2.5 Second LRC
*Short Circuit Protected
*Voltage Set Point:14.4V

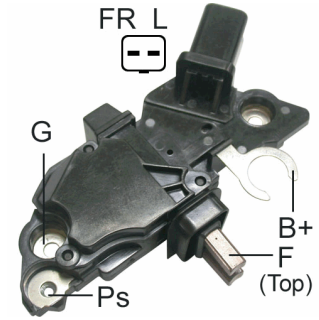

Replaces

BOSCH :
F00M145286 F00M145394 F00MA45233

Unit no.

BOSCH
0-124-525-035

VR-B271

*0.5 Second LRC
*Soft Start 18%
*Voltage Set Point:14.4V

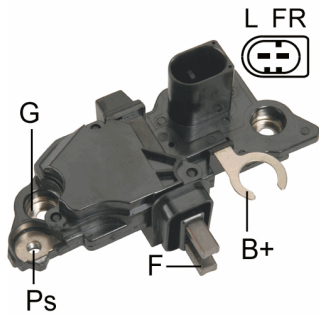

Replaces

AUDI/VW :
038903803F

BOSCH :

F00MA45209	F00M144136	F00M144153	F00M144154	F00M145195	F00M145200
F00M145223	F00M145225	F00M145233	F00M145234	F00M145315	F00M145333
F00M145344	F00M145350	F00M145354	F00M145383	F00M145384	F00M145891
F00MA45208	F00MA45232	F00MA45303	F00M145237	F00M145238	F00M145354
F00M145355					

Unit no.

BOSCH
0-124-325-019 0-124-515-028

VR-B280

*BSS Connections

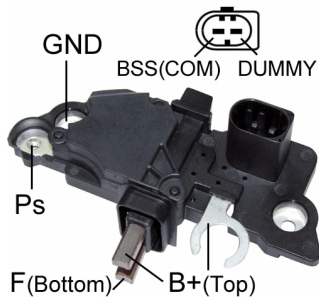

Replaces

BMW :

12317515319

BOSCH :

F-00M-A45-219 F-00M-145-678 F-00M-145-278 F-00M-A45-218 F-00M-145-280 F-00M-145-679

Unit no.

BOSCH

0-124-525-026 0-124-515-105

Used On

BMW

325 Series 2.5L	2004-
X3 2.5L	2004-
525i 2.5L	2004-
Z4 2.5L	2003-
Z4 3.0L	2003-

VR-B285

*Voltage Set Point: 14.3V
*COM

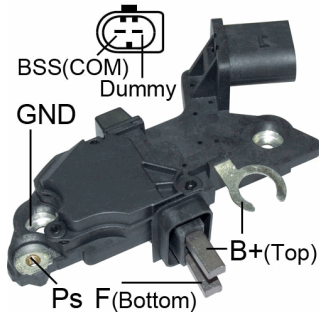

Replaces

BOSCH :

F-00M-145-285

Unit no.

BOSCH

0-124-515-051 0-124-515-098 0-124-515-045 0-124-525-042

VR-B296

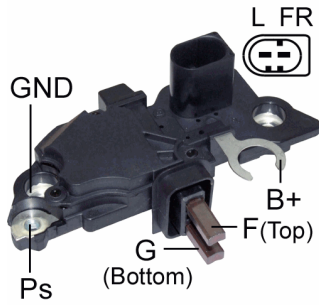

- *Soft Start
- *2.5 Second LRC
- *Short Circuit Protected
- *Voltage Set Point:14.6V

Replaces

BOSCH :

F-00M-145-261	F-00M-145-296	F-00M-145-341	F-00M-145-396	F-00M-145-397	F-00M-145-862
F-00M-145-876					

VOLKSWAGEN :

06F903803	06F903803A	06F903803AX	070903803B	070903803E	078903803E
-----------	------------	-------------	------------	------------	------------

Unit no.

BOSCH

0-124-215-008	0-124-325-044	0-124-325-076	0-124-325-081	0-124-325-083	0-124-325-095
0-124-325-096	0-124-325-097	0-124-325-125	0-124-325-138	0-124-325-140	0-124-515-040
0-124-515-059	0-124-515-068	0-124-525-008	0-124-525-010	0-124-525-050	0-124-525-067
0-124-525-087	0-124-525-089	0-124-525-092	0-124-525-095	0-124-615-009	0-124-615-021
0-124-615-031	0-124-615-038	0-124-625-010	0-124-625-018	0-124-625-028	0-124-215-009
0-124-315-031	0-124-315-032	0-124-325-061	0-124-325-066	0-124-325-067	0-124-325-073
0-124-325-088	0-124-325-131	0-124-515-103	0-124-515-117	0-124-515-122	0-124-515-125
0-124-525-090	0-124-615-007	0-124-325-132	0-124-315-036		

VR-B314

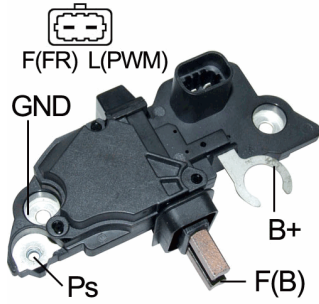

- *Voltage Set Point: 13.8V
- *Soft Start
- *2.5 sec. LRC
- *Short Circuit Protection
- *Regulated Voltage Control(RVC)
- *Requires VR-RVC01 test adaptor for testing

Replaces

BOSCH :
 F-00M-145-314 F-00M-145-328 F-00M-145-696

Unit no.

BOSCH					
0-124-425-032	0-124-425-049	0-124-425-063	0-124-425-064	0-124-525-072	0-124-525-104
0-124-425-007	0-124-425-008	0-124-425-030	0-124-425-031		
GM					
10335497	10366269	15233597			

Used On

CADILLAC

Escalade 8 Cyl. 5.3L 2005-

CHEVROLET

Avalanche 8 Cyl. 5.3L 2005-
 Silverado 6 Cyl. 4.3L 2005-2006
 Silverado 8 Cyl. 4.8L 2005-2007
 Silverado 8 Cyl. 5.3L 2005-
 Silverado 8 Cyl. 6.0L 2005-2007
 Suburban 8 Cyl. 5.3L 2005-
 Suburban 8 Cyl. 6.0 2006-
 Tahoe 8 Cyl. 4.8L 2005-2006
 Tahoe 8 Cyl. 5.3L 2006-

GMC

Sierra 6 Cyl. 4.3L 2005-2007
 Sierra 8 Cyl. 4.8L 2005-2007
 Sierra 8 Cyl. 5.3L 2005-
 Yukon 8 Cyl. 4.8L 2005-2006
 Yukon Denali 8 Cyl. 6.0L 2005-2006
 Yukon XL 8 Cyl. 5.3L 2005-
 Yukon XL 8 Cyl. 6.0L 2005-2006

VR-B360

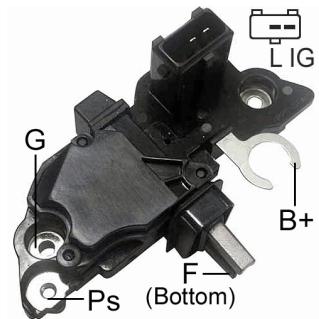

- *Soft Start
- *10 sec. LRC
- *Short Circuit Protection
- *Voltage Set Point: 14.5V

Replaces

BOSCH :
 F00M145251 F00M145254 F00M145360 F00MA45236

Unit no.

BOSCH
 0-124-515-050

VR-B363

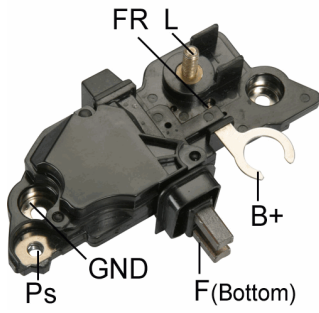

- * A-Circuit
- * Active Lamp
- * Soft Start
- * 5.0 sec. LRC
- * Short Circuit Protection
- * Voltage Set Point: 14.3V

Replaces

BOSCH :

F-00M-144-140 F-00M-145-260 F-00M-145-363

MERCEDES-BENZ :

0031545606 0031542906 0031549106

Unit no.

BOSCH

0-124-325-046 0-124-325-105 0-124-515-061 0-124-515-091 0-124-515-118 0-124-525-085
 0-124-525-109 0-124-615-015 0-124-615-035

MERCEDES-BENZ

0111547402 0121541702 0121542202 0131543202 0131543402 0131543602

VR-B369

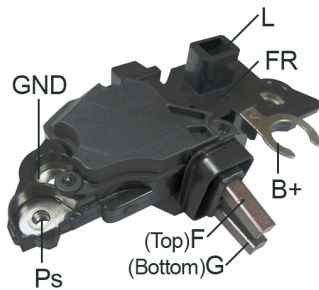

- *Soft Start
- *5 sec. LRC
- *Short Circuit Protection
- *Voltage Set Point: 14.6V

Replaces

BOSCH :

F00M145369 F00M145208 F00M145229 F00M145279 F00M145351 F00MA45211

Unit no.

BOSCH

0-124-625-001 0-124-625-003

VOLVO

8602713 8602714 8637849 8651665 8676499

VR-B371

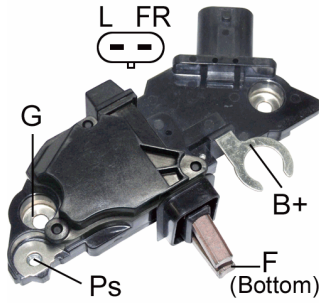

- *Soft Start
- *10 Second LRC
- *Short Circuit Protected
- *Voltage Set Point:14.5V

Replaces

BOSCH :

F00M145228 F00M145283 F00M145364 F00M145371 F00M144668 F00M144171
 F00M145265

GM :

93173428 93176049

Unit no.

BOSCH

0-124-415-009 0-124-415-025 0-124-425-004 0-124-425-019 0-124-425-048 0-124-515-032
 0-124-515-033 0-124-515-095 0-124-515-096 0-124-525-031

VR-B372

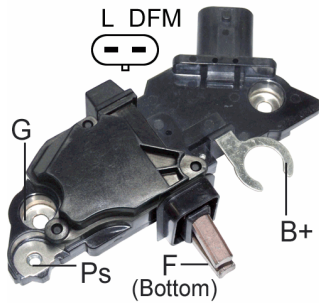

- *Soft Start
- *2.5 Second LRC
- *Short Circuit Protection
- *Voltage Set Point: 14.5V

Replaces

BOSCH :

F-00M-145-226

OPEL :

12793278

Unit no.

BOSCH

0-124-425-031 0-124-425-033 0-124-425-040 0-124-425-056 0-124-515-016 0-124-525-058
 0-124-525-086 0-124-525-097

VR-B379

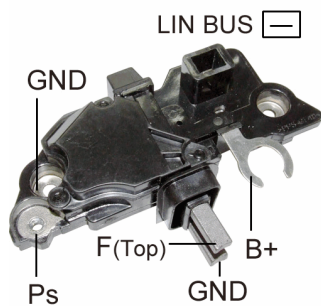

*Voltage Set Point: 13.8V
 * LIN-1
 * 9600 Baud Rate (4 Byte)

Replaces

BOSCH :

F-00M-145-311 F-00M-145-379 F-00M-A45-212

Unit no.

BOSCH

0-986-047-380 0-124-625-024 0-986-047-500 0-124-625-025 0-986-047-510 0-124-525-061

VOLVO

30658084 30667892 8603263 30658086 30667893 8603264

VR-B385

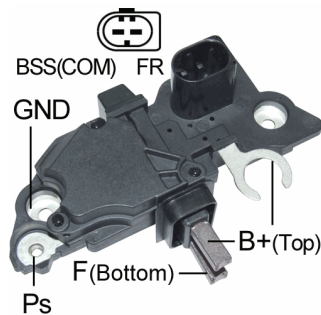

*BSS Connections

Replaces

BOSCH :

0031543706 0031545806 F00M145293 F00M145385 F00M144147 F00M145272
 F00M145367

Unit no.

BOSCH

0-124-615-028 0-124-525-113 0-124-625-059

VR-B391

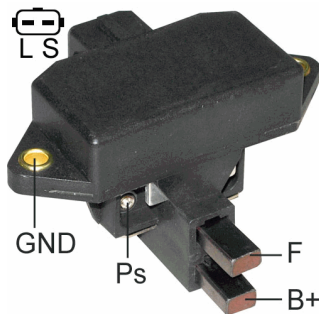

*For 28mm OD slip ring
*Voltage Set Point: 14.4V

Replaces

BOSCH :
9-190-067-016 9-190-067-017 9-190-067-019 9-190-067-020

FORD :
E9JY-10316A

MOTORCRAFT :
GRE802

Unit no.

BOSCH
9-120-060-009 9-120-060-020
FORD
89JA-10300AA E9JY-10346A

VR-B392

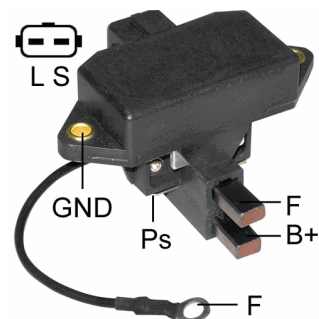

*For 28mm OD slip ring
*Voltage Set Point: 14.2V

Replaces

BOSCH :
9190067018

Unit no.

BOSCH
9-120-060-023

VR-B393

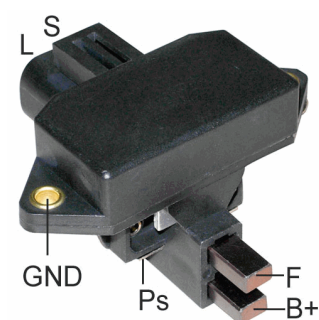

*For 28mm OD slip ring
*Voltage Set Point: 14.4V

Replaces

BOSCH :
9-191-067-043

Unit no.

BOSCH
9-120-061-100

VR-B394

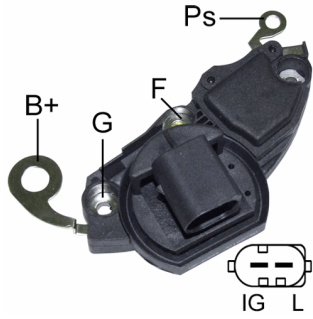

- *Soft Start
- *10 Second LRC
- *Short Circuit Protected
- *Voltage Set Point:14.5V

Replaces

BOSCH :
 F00M255200 F00M255201 F00M255202 F00M225200

Unit no.

BOSCH
 0-122-468-015

VR-B396

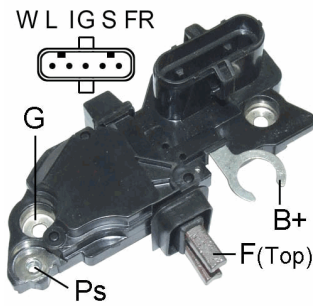

- *B-Circuit
- *Soft Start
- *0.5 sec. LRC
- *Short Circuit Protection
- *Loss of Sense Lamp Off
- *Voltage Set Point:28.3V

Replaces

BOSCH :
 F00M145302 F00M145307 F00M144107 F00M144123 F00M145256 F00M145298
 F00M144102 F00M145267 F00M145299

DAF :
 1600348

MERCEDES-BENZ :
 1542405 1542406 1542605 1542705

SCANIA :
 1501245 1501246 1502245

VOLKSWAGEN :
 2TB903803A

VOLVO :
 20802191

Unit no.

BOSCH
 0-124-355-001 0-124-355-002 0-124-555-001 0-124-555-002 0-124-555-003 0-124-555-004
 0-124-555-012 0-124-555-023 0-124-555-032 0-124-555-036

VR-B414

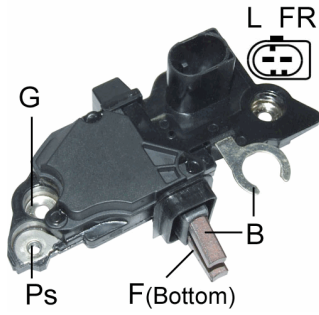

- *A-Circuit
- *Active Lamp
- *Soft Start
- *2.5 sec. LRC
- *Short Circuit Protection
- *Voltage Set Point:14.3V

Replaces

BOSCH :

F-00M-144-143 F-00M-144-153 F-00M-145-287 F-00M-145-372 F-00M-145-862

MERCEDES-BENZ :

31546006

Unit no.

BOSCH

0-124-325-077 0-124-615-025 0-124-625-006 0-124-515-012 0-124-615-046

Used On

MERCEDES-BENZ

Sprinter 2.2L

2003-2010

VR-B510

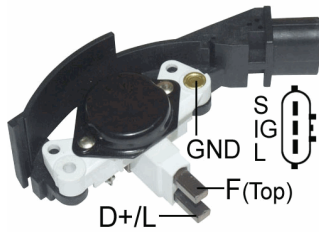

- *A-Circuit
- *Active Lamp
- *Voltage Set Point:14.4V

Replaces

BOSCH :

1-197-311-510

Unit no.

BOSCH

0-123-325-002 0-123-325-012 0-123-325-014

TOYOTA

27060-02100

Used On

TOYOTA

Avensis

1997-2000

Carena E Saloon(T19)

1997-

Carena E(T19)

1997-

VR-B543B

*Voltage Set Point: 28.4V

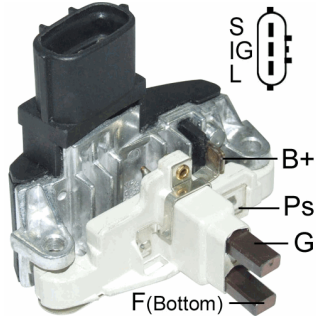

Replaces

BOSCH :
1197311543 123500520
IVECO :
42532975

Unit no.

BOSCH
0-123-525-500 0-123-525-502

VR-B558B

*L Terminal Drive Choke
*Soft Start
*Short Circuit Protection
*Voltage Set Point:25.6V

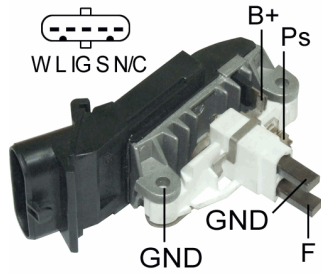

Replaces

BOSCH :
1-197-311-558
MAN :
81256010025

Unit no.

BOSCH
0-123-325-500 0-123-525-501

VR-B861

*Soft Start
*Short Circuit Protection
*Voltage Set Point: 14.5V

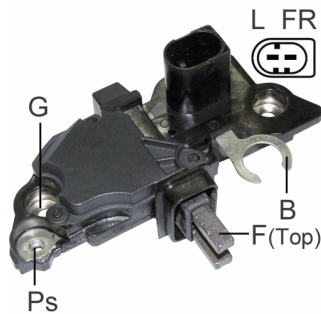

Replaces

BOSCH :
F-00M-145-340 F-00M-145-861

Unit no.

BOSCH
0-124-625-007 0-124-515-055 0-124-515-131 0-124-615-012 0-124-615-044 0-124-615-047
0-124-515-047 0-124-325-040 0-124-325-045

Used On

MERCEDES-BENZ

C180 2.0L 2000-2001
ML500 5.0L 2003-2006

VR-B880

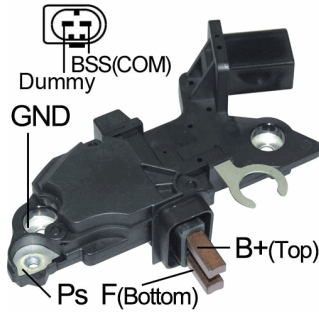

*Voltage Set Point: 14.3V
*COM

Replaces

BOSCH :

F-00M-145-880 F-00M-145-262

Unit no.

BMW

12317521384	12317521490	12317521491	12317532965	12317532966	12317532969
12317533270					

BOSCH

0-124-525-045	0-124-525-059	0-124-515-051	0-124-515-098	0-124-525-042	0-124-525-048
---------------	---------------	---------------	---------------	---------------	---------------

Used On

BMW

116 Z4 Series	2004-
316Ci 1.6L	2002-2004
318 Ci 2.0L	2001-
318i 2.0L	2004-
316ti 1.8L	2001-2004

VR-B883

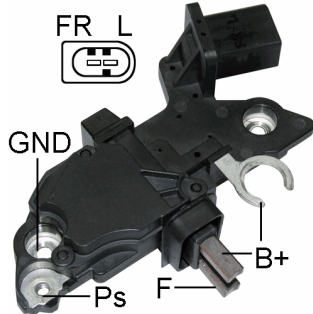

*Soft Start
*5.0 sec. LRC
*Short Circuit Protection
*Voltage Set Point:14.0V

Replaces

BOSCH :

F-00M-145-266 F-00M-145-365 F-00M-145-883

MERCEDES-BENZ :

0031545706

Unit no.

BOSCH

0-124-625-019	0-124-525-161	0-124-625-002	0-124-625-004
---------------	---------------	---------------	---------------

VR-C524

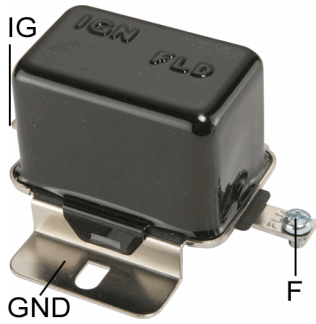

*Electronic type
*Voltage Set Point: 14.5V

Replaces

CHRYSLER :

1889960	2095700	2098300	3000074	CH524
---------	---------	---------	---------	-------

Unit no.

CHRYSLER

2095000	2095060	2095100	2095300	2095425	2095661
3438171					

VR-C545

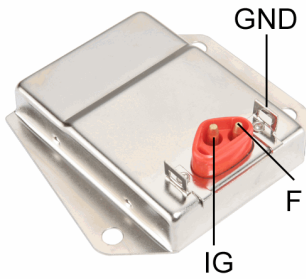

*Voltage Set Point: 14.7V

Replaces

CHRYSLER :

3438150	3755850	3755960	3874520
---------	---------	---------	---------

Unit no.

CHRYSLER

3237797	3438846	3438847	3656570	3755585	4091727
---------	---------	---------	---------	---------	---------

VR-C545H

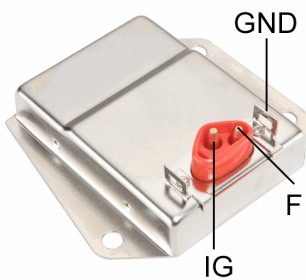

*Heavy Duty
*Voltage Set Point: 14.7V

Replaces

CHRYSLER :

3438150	3755850	3755960	3874520	3755970	4003708
4091050	4111990	4144187	5234625	CH537	CH543
CH544	CH545				

Unit no.

CHRYSLER

3237797	3438846	3438847	3656570	3755585	4091727
---------	---------	---------	---------	---------	---------

VR-D271

*Voltage Set Point:14.6V

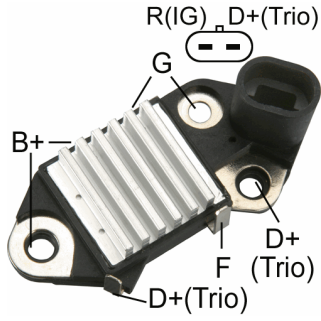

Replaces

DAEWOO :
271910

Unit no.

DAEWOO
219170 96380673

VR-D276

*Voltage Set Point:14.7V

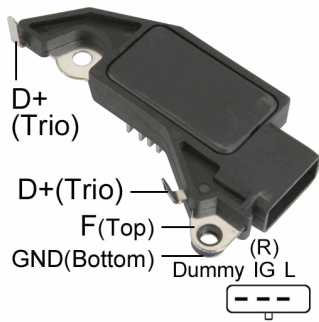

Replaces

DAEWOO :
276010
DELCO :
276010

VR-K03

*Voltage Set Point: 14.4V

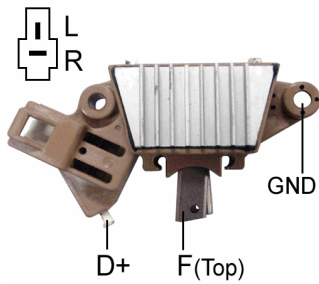

Unit no.

DAEWOO
31410-A80D00

VR-K04

*Voltage Set Point: 14.6V

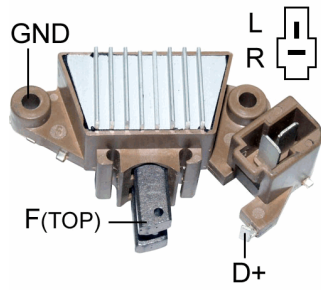

Replaces

DAEWOO :
DAD25006D

Unit no.

DAEWOO
31400-A78B02 31400-A78-130

Used On

DAEWOO
Tico 0.8

1995-2000

VR-D001B

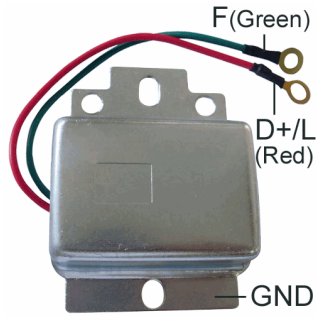

*24V
*Voltage Set Point:28.2V

Replaces

CATERPILLAR :
2P1699

PRESTOLITE :

8-393	8-394	83-93	83-94	VSH-6401C	VSH-6401CS
VSH-6401D	VSH-6401ES	8393	8-394	VSH6401C	VSH6401D
VSH-6401ES					

Unit no.

PRESTOLITE
ANB7001 ANB7002 ANB7003 ANB7004

VR-D100

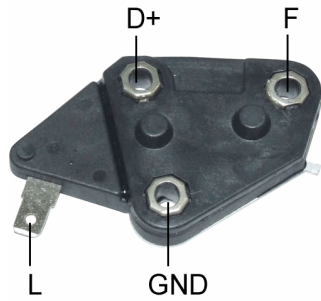

*Voltage Set Point:14.3V

Replaces

DELCO :
94652566

VR-D1033

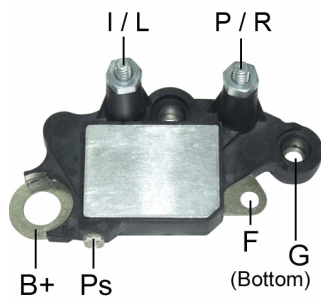

*Self Exciting
*Short Circuit Protection
*Voltage Set Point: 14.2V

Replaces

DELCO :
10521033

Unit no.

DELCO
8600310 8600889

VR-D231

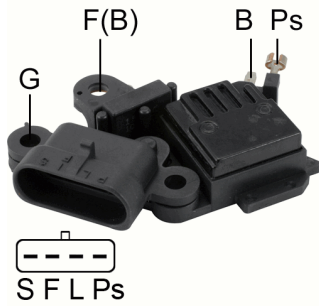

- *Soft Start
- *8.5 sec. LRC w/open sense indication
- *Short Circuit Protection
- *Voltage Set Point:14.8V

Replaces

DELCO :

10458198	10453673	10483777	10483778
----------	----------	----------	----------

Unit no.

DELCO

10464408	10464421	10464430	10464439	10464492	10480411
25744164	25744165				

VR-D232

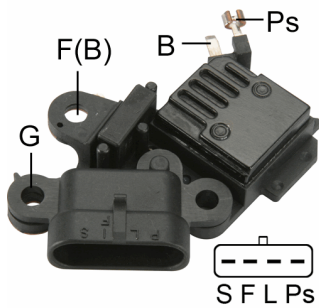

- *Soft Start
- *2.5 sec. LRC
- *Short Circuit Protection
- *Voltage Set Point:14.8V

Unit no.

DELCO

10464406	10480327	10480341	3211750
----------	----------	----------	---------

VR-D233

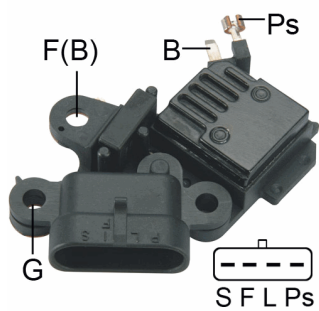

- *Voltage Set Point:14.8V
- *2.5 sec. LRC w/open sense indication

Replaces

DELCO :

10458202	15063025	15163024
----------	----------	----------

Unit no.

DELCO

10464459	10464460	10464483	10464484	15056100	15087020
15087021					

VR-D234

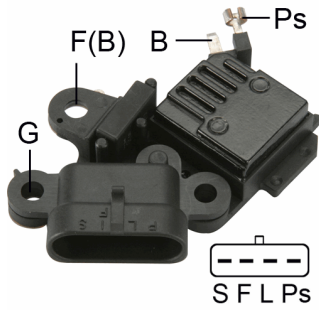

*Voltage Set Point:14.8V
*8.5 sec. LRC

Replaces

DELCO :
10484046

Unit no.

DELCO
10480368 10480428

VR-D235

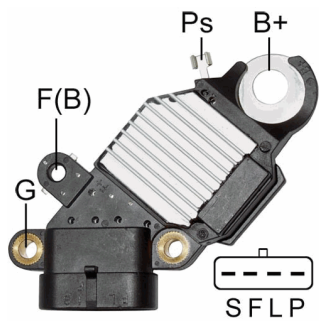

*S-F-L-P Terminals
*B-Circuit
*Inactive Lamp
*Soft Start
*2.5 sec. LRC
*Short Circuit Protection
*Lamp off when S Open
*Voltage Set Point:14.8

Replaces

DELCO :
19060319 19060345

Unit no.

DELCO
10464476 15226003 15754097 15754097A 15754097M 15754097W

VR-D235SE

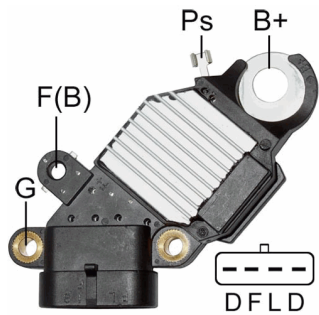

*With Self-Exciting
*B-Circuit
*Voltage Set Point:14.6V

Replaces

DELCO :
10483643 10486311 19053013 19053730 19054622 19060319

VR-D238

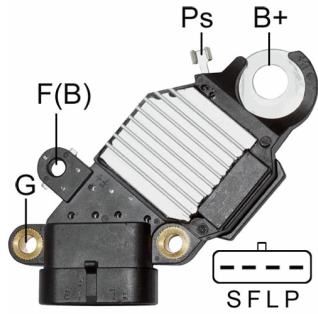

- *B-Circuit
- *Inactive Lamp
- *Soft Start
- *8.5 sec. LRC
- *Short Circuit Protection
- *S Open Lamp On
- *S-F-L-P Terminals
- *Voltage Set Point:14.8V

Replaces

DELCO :
 10453673 10458198 10483777 10483778

VR-D239

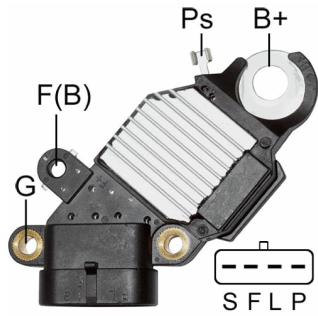

- *B-Circuit
- *Soft Start
- *8.5 sec. LRC
- *Short Circuit Protection
- *S Open Lamp Off
- *Voltage Set Point:14.8V

Replaces

DELCO :
 10454656 10458203

VR-D406B

- *Voltage Set Point: 27.9V

Replaces

DELCO :
 19020406

VR-D412

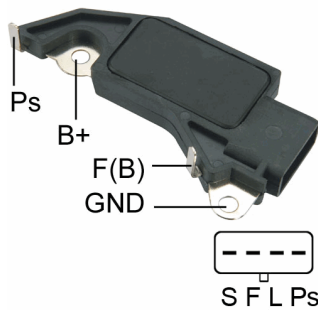

- *P-L-F-S Terminals
- *Soft Start
- *8.5 sec LRC
- *Short Circuit Protection
- *Voltage Set Point:14.6V

Replaces

DELCO :
 1116412 19009712

VR-D424

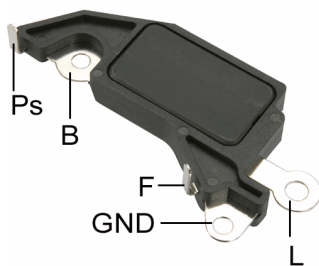

- *L Terminal Drives Choke
- *Soft Start
- *Voltage Set Point:14.7V

Replaces

DELCO :
1116424

Unit no.

DELCO
1101199 1101551

VR-D432

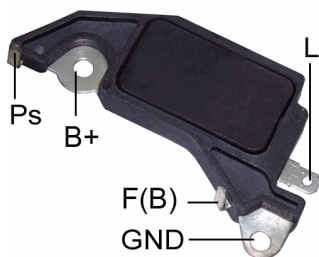

- *L Terminal Drives Choke
- *Soft Start
- *Voltage Set Point:14.7V

Replaces

DELCO :
1116432

Unit no.

DELCO
1101816

VR-D440

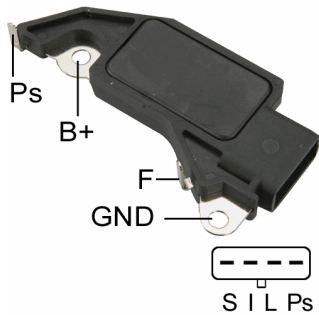

- *L Terminal Drives Choke
- *Soft Start
- *Voltage Set Point:14.7V

Replaces

DELCO :
1116440

Unit no.

TOYOTA
27060-02050 27060-74200

VR-D445

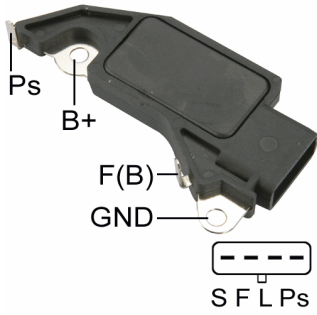

- *B-Circuit
- *Inactive Lamp
- *Soft Start
- *8.5 sec. LRC
- *Short Circuit Protection
- *S-F-L-Ps Terminals
- *With Instrument Cluster Gauges
- *Voltage Set Point:14.6V

Replaces

DELCO :
1116445

Unit no.

DELCO
10480055 10480227 10480265 10480278 10480296 10480297
10480311

VR-D579H

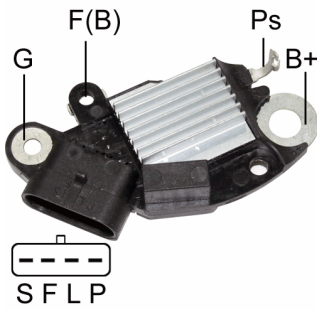

- *Soft Start
- *2.5 sec. LRC
- *Short Circuit Protection
- *S Open Lamp Off
- *Voltage Set Point: 14.6V

Replaces

DELCO :
10503579

Unit no.

DELCO
15200109 15845337 15845338 15847291

VR-D602H

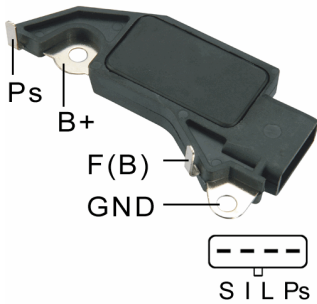

- *B-Circuit
- *Inactive Lamp
- *Soft Start
- *8.5 sec. LRC
- *Short Circuit Protection
- *S-I-L-Ps Terminals
- *Voltage Set Point:14.6V

Replaces

DELCO :
1116446 D602A

Unit no.

DELCO
10480135 10480171 CS144

VR-D635

*Electronic Type
 *Voltage Set Point:14.5V

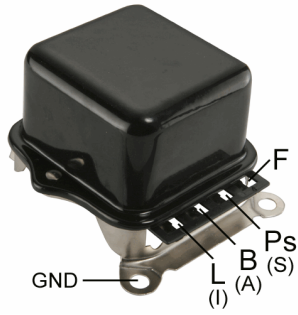

Replaces

DELCO :

1119506	1119512	1119515	1119519	D635	D663
---------	---------	---------	---------	------	------

Unit no.

DELCO

1100553	1100557	1100558	1100566	1100567	1100568
1100569	1100570	1100571	1100572	1100590	1100591
1100600	1100601	1100605	1100613	1100615	1100616
1100619	1100654	1100688	1100693	1100694	1100699
1100721	1100722	1100821	1100834	1100836	1100837
1100838	1100839	1100841	1100842	1100843	1100845
1100846	1100847	1100849	1100856	1100860	1100870
1100871	1100875	1100878	1100879	1100886	1100888
1100889	1102434	1102435	1102437	1102439	1102440
1102455	1102943	1102944	1102945	321161	321164
321169	321182				

VR-D668B

*24V
 *For use on One wire hook-up,
 *low cut-in,Agricultural,
 *Industrial and Marine Application
 *Voltage Set Point:28.0V

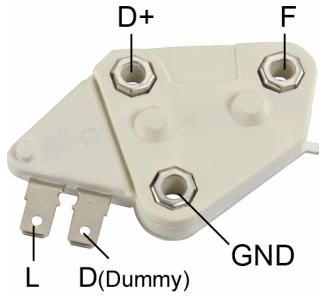

Replaces

DELCO :

234060

VR-D668C

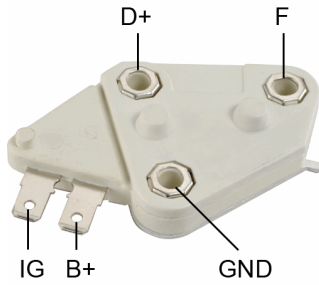

*VR-D668CL (Volts setting 14.2V)
 *For use on Delco 10, 12&15SI Alternators
 *Voltage Set Point:14.7V

Replaces

AMC :

8125176

BOSCH :

0-986-192-000

DELCO :

233738	1116392	D668	D680	1116380	1116384
1116385	1116387	1116387H	1116423	13472406	16003652
3472406	7896932	DR600	DR666	DR667	DR668
DR680					

LUCAS :

21226042 UCB701

MOTORCRAFT :

GR307

OPEL :

1204236

Unit no.

DELCO

10456313	10479850	10479925	10497083	1100109	1100110
1100111	1100113	1100115	1100116	1100117	1100119
1100120	1100121	1100124	1100125	1100127	1100128
1100129	1100130	1100131	1100132	1100133	1100134
1100135					

VR-D669C

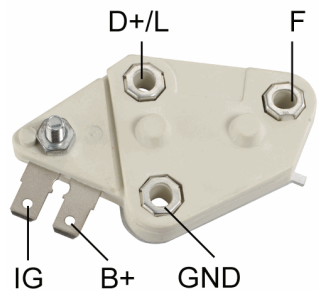

*For use on Delco 10SI type 116, 20SI, 27SI type 200
 *For use on Delco 30 & 40SI
 *Voltage Set Point:14.2V

Replaces

DELCO :

1116360	1116389	1116390	13001740	1876388	9343233
DR669					

MOTORCRAFT :

GR536

Unit no.

DELCO

10459017	10459036	1117160	1117163	1117880	1117885
1117886	1117887	1117890	1117891	1117919	

VR-D670C

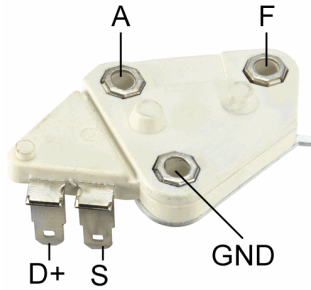

*For use on Opel, Triumph, Vauxhall
 *Voltage Set Point:14.7V

Replaces

DELCO :				
7934605	7934614	7982866		
LUCAS :				
21226041	UCB700			
OPEL :				
1204245				

VR-D671C

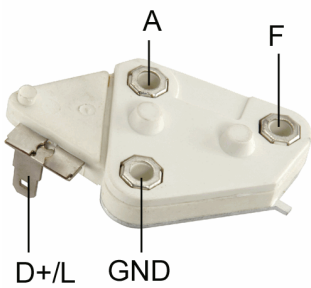

*For use on:
 *Austin,Princess,Commer,Leyland,MG,MGB8,Vauxhall,Opel
 *Voltage Set Point:14.7V

Replaces

DELCO :				
21226043	7982685			
LUCAS :				
UCB702				
MAGNETI MARELLI :				
940038033				

VR-D672C

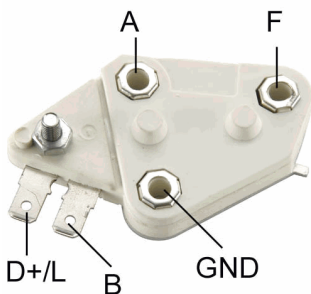

*24V
 *For use on Delco 20SI Type 200, 29SI & 30SI
 *Voltage Set Point:27.5V

Replaces

CATERPILLAR :				
3T6353	3T6354	6N1874	7N7799	9N1207
DELCO :				
1105510	1116388	1984287		

Unit no.

DELCO					
10SITYPE116	1103123	1105475	1987518	20SI	27SITYP200
29SI	30SI	321648	321651	321654	

VR-D673C

*For use on Opel, Vauxhall
 *Voltage Set Point: 14.7V

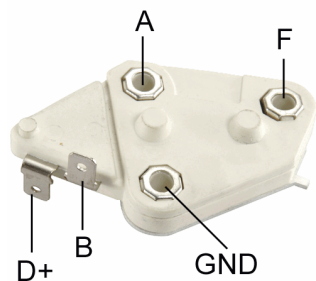

Replaces

BOSCH :

0-986-192-015

DELCO :

13472557 3472557 3493050

DELCO REMY (LUCAS) :

21226104

GM :

3474557

LUCAS :

UCB703

MAGNETI MARELLI :

940038032

OPEL :

1204248

VALEO(DUCELLIER) :

592983

Unit no.

DELCO

3472020	3472021	3472023	3472028	3472032	3472033
3472037	3472038	3472042	3472048	3472049	3472050
3472051	3472052	3472053	3472057	3472058	3472059
3472060	3472061	3472062	3472063	3472064	3472065
3472066	3472067	3472068	3472069	3472070	3472072
3472073	3472074	3472075	3472082	3472091	

VR-D674

*VR-D674 For 5A. Field
 *For use on OPEL, VAUXHALL
 *Voltage Set Point:14.8V

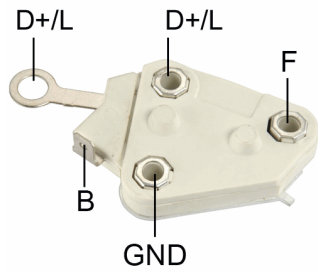

Replaces

DELCO :			
3493029	3493030	3493079	3493080
LUCAS :			
UCB705			
OPEL :			
1204257	1204258	1204263	1204264
VALEO :			
A564796A			

Unit no.

DELCO					
3472104	3472105	3472106	3472119	3472120	3472121
3472128	3472130	3472134	3472135	3472136	3472137
3472139	3472142	3472143	3472144	3493604	3493606
3493619	3493621	3493634	3493635	3493639	3493641
3493644	3493704	3493706			

VR-D674H

*For 8A. Field
 *For use on OPEL, VAUXHALL
 *Voltage Set Point:14.8V

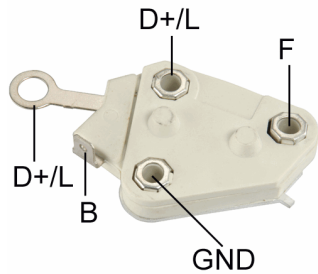

Replaces

DELCO :			
3293030	3493029	3493079	3493080
LUCAS :			
UCB705			
OPEL :			
1204257	1204258	1204263	1204264

Unit no.

DELCO					
3472104	3472105	3472106	3472119	3472120	3472121
3472128	3472130	3472134	3472135	3472136	3472139
3472142	3472143	3472144	3493604	3493606	3493619
3493621	3493634	3493635	3493639	3493641	3493644
3493704	3493706	3742106			

VR-D675H

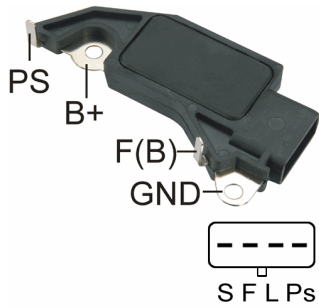

- *B-Circuit
- *Inactive Lamp
- *Soft Start
- *2.5 sec. LRC
- *Short Circuit Protection
- *S-F-L-Ps Terminals
- *Voltage Set Point: 14.6V

Replaces

DELCO :				
1116408	1116428	D675	D699	

Unit no.

DELCO	
CS130	CS144

VR-D676

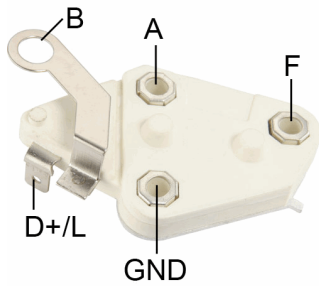

- *For use on OPEL, VAUXHALL
- *Voltage Set Point: 14.7V

Replaces

DELCO :	
9315303	9345333
LUCAS :	
UCB704	
VALEO(DUCCELLIER) :	
592984	

VR-D677

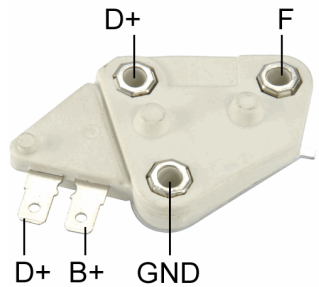

- *Voltage Set Point: 14.7V

Replaces

DELCO :	
1988988	D674

Unit no.

DELCO					
10479930	10497082	1101134	1101215	1101224	1101236
1101252	1101258	1101280	1101290	1101308	1101324
1101328	1105366	1105402	1105442	1105445	1105448
1105480	1105481	1105491	1105492	1105499	1105505
1105515	1105543	1105558	1105571	1105581	1105585
1105595	1105596	1105606	1105618	1105623	1105627
1105628	1105629	1105630	1105632	1105633	1105648
1105655	1105656	1105658	1105680	1105683	1105690
1105696	1105700	321267	321269	321648	

VR-D678H

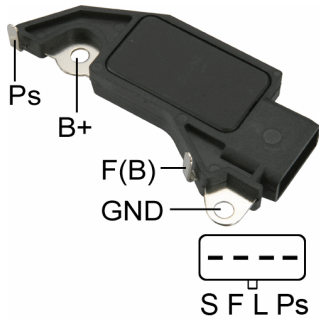

- *P-L-F-S Terminals
- *Soft Start
- *10 Second LRC
- *Short Circuit Protected
- *Voltage Set Point:14.2V

Replaces

DELCO :

D678 D684

Unit no.

DELCO

10480018	10480019	10480120	1101133	1101270	1101295
1101330	1101574	1101591	1101850	3211029	3211071
321368	321485				

VR-D679SE

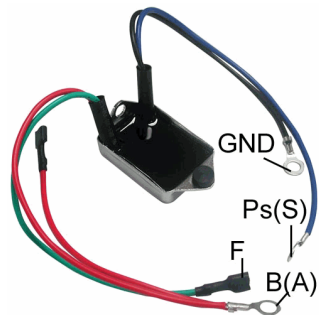

- *Self Exciting
- *Voltage Set Point:14.8V

VR-D680

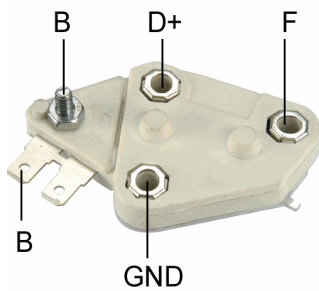

- *For use on Delco 20SI, 21SI, 26SI
- *With Webbed Terminals
- *Voltage Set Point:14.0V

Replaces

DELCO :

1116433 1116435 1116442 6159599 D686 DVR202

Unit no.

DELCO

10459017	10459036	1117160	1117163	1117880	1117885
1117886	1117887	1117890	1117891	1117892	1117894
1117895	1117903	1117905	1117906	1117909	1117910
1117913	1117914	1117916	1117917	1117918	1117919
1117925	1117926	1117936			

VR-D681H

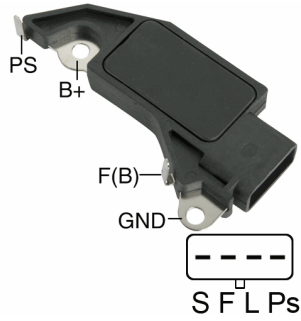

- *B-Circuit
- *Inactive Lamp
- *Soft Start
- *8.5 sec. LRC
- *Short Circuit Protection
- *S-F-L-Ps Terminals
- *With Instrument Cluster Gauges
- *Voltage Set Point:14.6V

Replaces

DELCO :

1116413	1116430	D600A	D681
---------	---------	-------	------

Unit no.

DELCO

10463096	10463108	10463119	10463121	10463122	10463189
10463190	10463201	10463295	10463442	10479995	10480008
10480055	10480116	1101296	1101490	1101518	1101519
1101578	321387	321399	321410	321412	321413
321481	321482	321492	321580	321581	

VR-D682

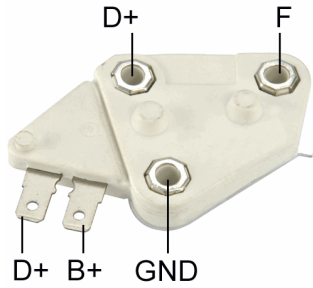

- *For Use on: Delco 21SI Alternators
- *Voltage Set Point:14.0V

Replaces

DELCO :

1116438	1116439	1116441
---------	---------	---------

Unit no.

DELCO

1117926	1117936	1117939	1117940
---------	---------	---------	---------

VR-D683H

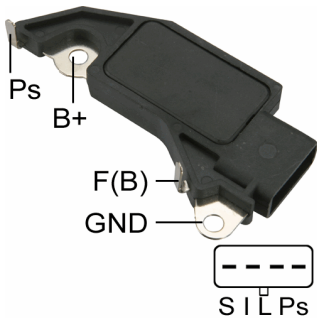

- *S-I-L-PS Terminals
- *Soft Start
- *2.5 Second LRC
- *Short Circuit Protected
- *Voltage Set Point:14.2V

Replaces

DELCO :

1116425	D683
---------	------

Unit no.

DELCO

10479852	10479959	10479976	1101482	1101561	1101571
1101605	1101616	1101625	1101806	CS130	CS144

VR-D686

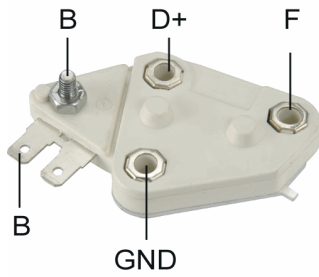

- *For Use On: Delco 10SI, 20SI, 21SI, 26SI, 29SI & 30SI
- *With Webbed Terminals
- *Voltage Set Point: 14.2V
- *Heavy Duty Version

Replaces

DELCO :

1116406	1116407	1116435	1894489	D672
---------	---------	---------	---------	------

Unit no.

DELCO

10459017	10459036	1117160	1117163	1117880	1117885
1117886	1117887	1117890	1117891	1117892	1117894
1117895	1117903	1117905	1117906	1117909	1117910
1117913	1117914	1117916	1117917	1117918	1117919

VR-D687

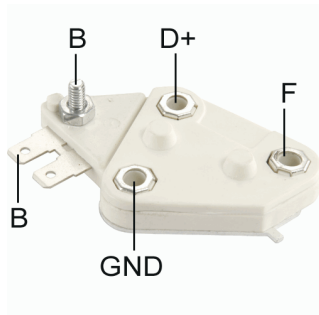

- *24V
- *For Use On: Delco 10SI Type 116, 20SI, 27SI Type 200, 29SI & 30SI
- *With Webbed Terminals
- *Voltage Set Point: 27.5V

Replaces

DELCO :

1116388	1987518
---------	---------

Unit no.

DELCO

10SITYPE116	1100077	1100211	1101285	1102916	1102918
1102919	1102934	1103123	1105475	20SI	27SITYPE200
29SI	30SI	321654			

VR-D689

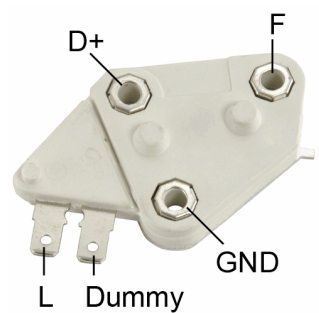

- *Agricultural, Industrial & Marine Applications Self Exciting
- *For 12V Systems One Wire Hook-up
- *Voltage Set Point: 14.7V

VR-D690

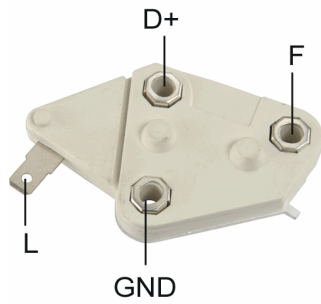

- *A-Circuit
- *Inactive Lamp
- *Voltage Set Point:14.7V

Replaces

CATERPILLAR :

9L6774

DELCO :

D686

D687

D690

94648534

1116433

1116435

1116442

VR-D691

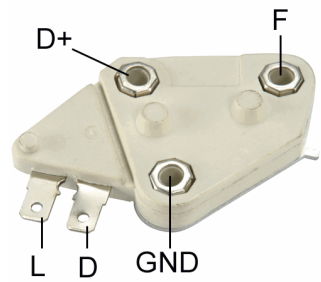

- *Self Exciting For 6V System
- *Agricultural, Industrial & Marine Applications
- *Voltage Set Point:7.8V

Replaces

DELCO :

234058

VR-D692

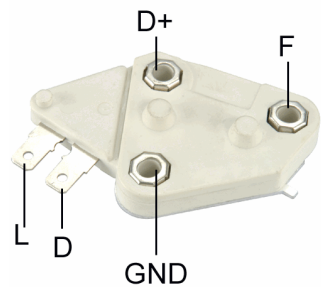

- *Self Exciting For 8V System
- *For use on: One wire hook-up,
- *low cut-in, Agricultural, Industrial and Marine Applications
- *Voltage Set Point:9.7V

VR-D694H

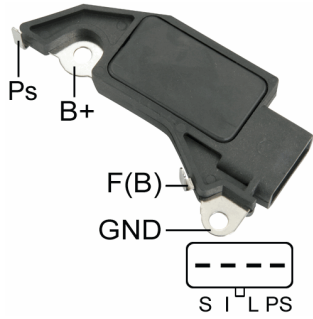

- *B-Circuit
- *Inactive Lamp
- *Soft Start
- *2.5 sec. LRC
- *Short Circuit Protection
- *S-I-L-Ps Terminals
- *Without Adapter Plug
- *Voltage Set Point:14.6V

Replaces

DELCO :

1116429	1116436	1116437	1116439	1116440	D677
D685	D698				

Unit no.

DELCO					
10479805	10480095	10480096	1101584	1101626	CS121
CS130	CS144				

VR-D694HD

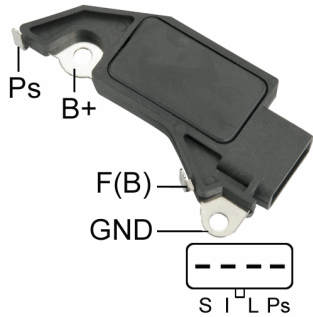

- *With Ridged Heat Sink
- *Without adapter plug
- *Voltage Set Point:14.6V

Replaces

DELCO :

1116411	1116429	1116436	1116437	1116439	1116440
D677	D685	D698			

Unit no.

DELCO					
10479805	10480095	10480096	1101584	1101626	

VR-D694SC

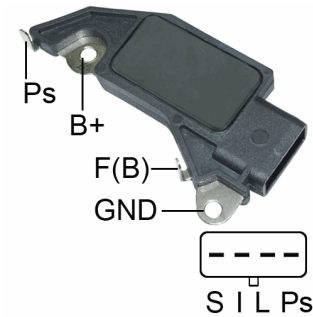

- *Heavy Duty Version
- *Voltage Set Point:14.6V

Replaces

DELCO :

1116411	1116429	1116436	1116437	1116439	1116440
D677	D685	D698			

Unit no.

DELCO					
10479805	10480095	10480096	1101584	1101626	

VR-D694SE

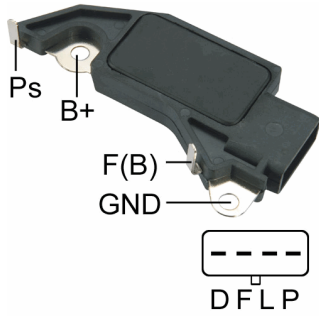

- *B-Circuit
- *D-F-L-P Terminals
- *Self Exciting
- *Voltage Set Point:14.6V

Replaces

DELCO :

1116411	1116429	1116436	1116437	1116439	1116440
D677	D685	D698			

VR-D696B

- *Voltage Set Point:27.5V

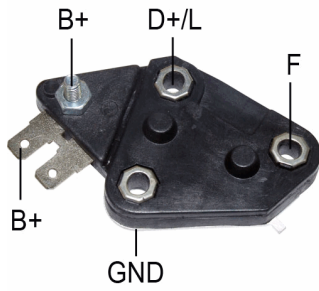

Replaces

DELCO :

1105510	1116388	1116404	1116405	1894460	1984287
1987518					

Unit no.

DELCO

102934	11000211	1100077	1100078	1101285	1102916
1102918	1102919	1103123			

VR-D701

*B+ - L Terminals
 *Voltage Set Point: 14.6V

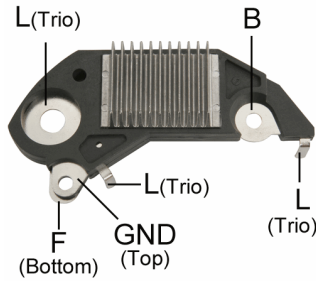

Replaces

DELCO :
 10475019 19009701 19009716

GM :
 140475019

MAGNETI MARELLI :
 940038030

OPEL :
 1204270

Unit no.

DELCO					
10479914	10479923	10479947	10479955	QY6J5	
GM					
3493814	3493823	3493847	3493855		
OPEL					
6204002	6204006	6204007	6204008		

VR-D702H

*B-Circuit
 *Inactive Lamp
 *Soft Start
 *2.5 sec. LRC
 *Short Circuit Protection
 *S-I-L-Ps Terminals
 *Voltage Set Point: 14.6V

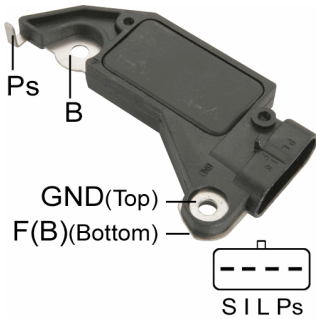

Replaces

DELCO :
 19009702 19009719

Unit no.

DELCO					
10463663	10470119	10479981	10479984	10480017	10480052
10480071	10480072	10480119			
OPEL					
3211008	3211023	3211025	3211026	3211027	3211031
3211051					

VR-D702SE

*B-Circuit
 *D-F-L-D Terminals
 *D: Dummy
 *Self Exciting
 *Voltage Set Point: 14.6V

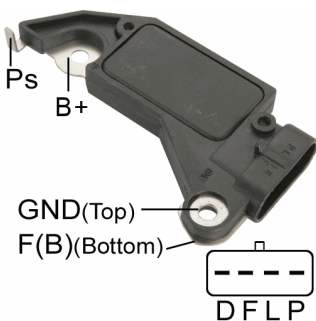

VR-D703H

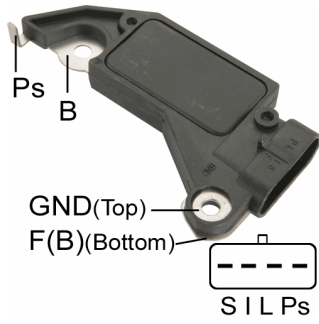

- *B-Circuit
- *Inactive Lamp
- *Soft Start
- *8.5 sec. LRC
- *Short Circuit Protection
- *S-I-L-Ps Terminals
- *Voltage Set Point:14.6V

Replaces

DELCO :
19009703

Unit no.

DELCO
10480043 3211048

VR-D705H

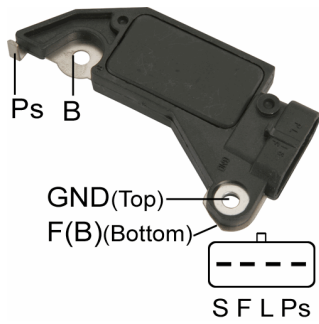

- *B-Circuit
- *Inactive Lamp
- *Soft Start
- *8.5 sec. LRC
- *Short Circuit Protection
- *S-F-L-Ps Terminals
- *Voltage Set Point: 14.6V

Replaces

DELCO :
19009705

Unit no.

DELCO
10480074 10480076 10480079

VR-D706H

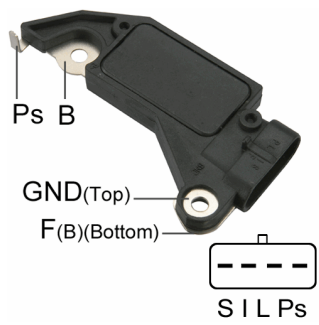

- *B-Circuit
- *Inactive Lamp
- *P-L-I-S Terminals
- *Soft Start
- *2.5 Second LRC
- *Short Circuit Protected
- *Voltage Set Point:14.2V

Replaces

DELCO :
19009706

VR-D707

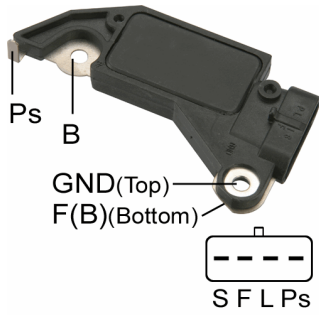

- *B-Circuit
- *Inactive Lamp
- *Soft Start
- *2.5 sec. LRC
- *Short Circuit Protection
- *P-L-F-S Terminals
- *Voltage Set Point:14.8V

Replaces

DELCO :

19009718 19009748

Unit no.

DELCO

10464413	10464424	10464427	10464437	10464462	10480288
10480318	10480331	10480336	10480378		

VR-D708

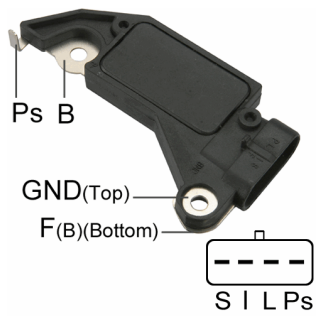

- *B-Circuit
- *Inactive Lamp
- *Soft Start
- *2.5 sec. LRC
- *Short Circuit Protection
- *P-L-I-S Terminals
- *2.5 Second LRC
- *Voltage Set Point: 14.8V

Replaces

DELCO :

19009719

Unit no.

DELCO

10464407	10464457	10480343	15757624
----------	----------	----------	----------

VR-D709

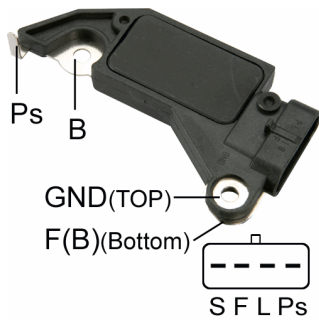

- *B-Circuit
- *Inactive Lamp
- *Soft Start
- *8.5 sec. LRC
- *Short Circuit Protection
- *P-L-F-S Terminals
- *Voltage set point: 14.8V

Replaces

DELCO :

19009729

Unit no.

DELCO

10464415	10464423	10464431	10464432	10480320	10480346
10480361	10480362	3211759			

VR-D711

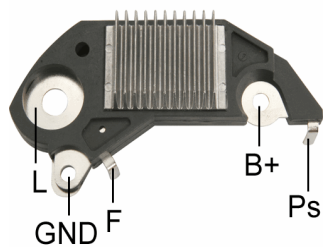

- *Soft Start
- *4.0 sec. LRC
- *Voltage Set Point:14.6V

Replaces

DELCO :
19009708 10493240

GM :
10493240

OPEL :
1204288

Unit no.

DELCO
90543910
OPEL
6204072

VR-D712

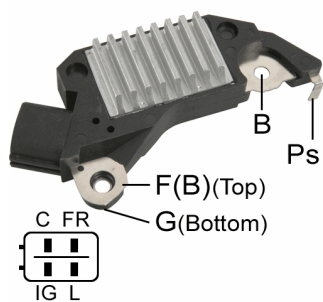

- *C-FR-IG-L
- *Soft Start
- *Short Circuit Protection
- *For use on Delco CS130D Series IR/IF
Alternators
- *Voltage Set Point:14.8V

Replaces

DELCO :
19009715

HITACHI :
TR1Z-125

Unit no.

DELCO
10480228 10480497
HONDA
31100-P8A-A01 31100-P8A-A02

VR-D713

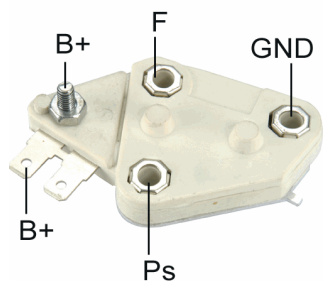

- *Self-Exciting
- *Voltage Set Point:14.6V

VR-D714SE

- *B-Circuit
- *PS open Lamp on
- *Voltage Set Point: 14.2V

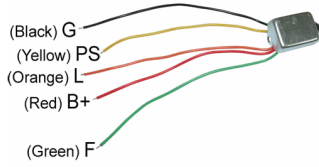

Replaces

DELCO :
 235864

VR-D715

- *Voltage Set Point: 14.5V
- *Soft Start
- *2.5 sec. LRC
- *Short Circuit Protection

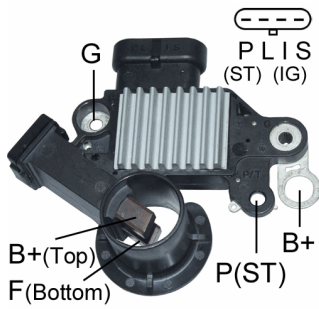

Unit no.

DELCO
 96408588

Used On

SUZUKI

Forenza	2.0L	2004-2007
Reno	2.0L	2005-2007
Swift	1.6L	2004-2005
Verona	2.5L	2004-2006

VR-D716

- *Voltage Set Point: 14.5V

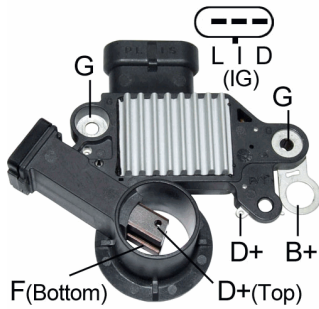

Unit no.

GM
 96954112

Used On

SUZUKI

Forenza 2.0L		2004-2008
Reno 2.0L		2005-2008

VR-D717

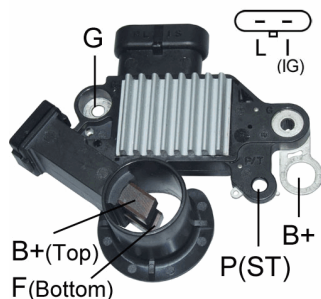

- *A-Circuit
- *1-L Terminals
- *Inactive Lamp
- *Soft Start
- *2.5 sec. LRC
- *Short Circuit Protection
- *Voltage Set Point:14.5V
- *For use on Korean Delco Alternators

Unit no.

GM

96540542

96838439

SUZUKI

31400-85Z00

VR-D718

*Delco 21SI, 22SI, 26SI, 33SI, 34SI, 35SI, 36SI Series IR/EF Alternators

Replaces

DELCO :

1116433

1116435

VR-D719

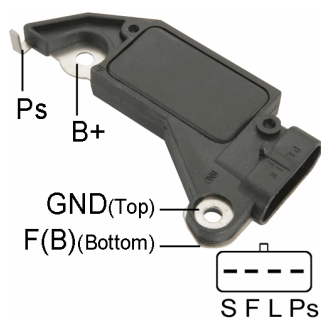

- *B-Circuit
- *Inactive Lamp
- *Soft Start
- *8.5 sec. LRC
- *Short Circuit Protection
- *Voltage Set Point:14.8V

Replaces

DELCO :

19009736

19009751

Unit no.

DELCO

10480280

10480340

VR-D720

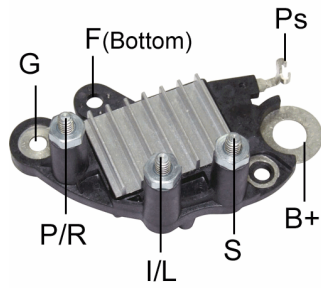

- *Self Exciting
- *Short Circuit Protection
- *Voltage Set Point:14.2V

Unit no.

DELCO

8600307

8600311

8600313

8600314

8600316

VR-D740

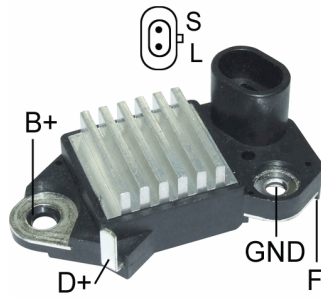

- *S-L Terminals
- *Voltage Set Point:14.6V

Replaces

DELCO :

271940

Unit no.

DAEWOO

266000

219170

96380673

DELCO

19020601

19020612

19020609

19020611

VR-D744

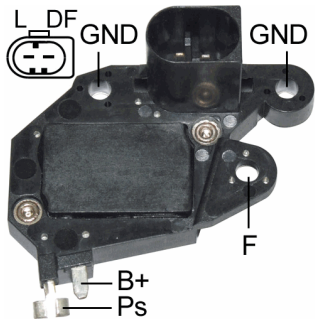

- *B-Circuit
- *Active Lamp
- *Soft Start
- *2.5 sec. LRC
- *Short Circuit Protection
- *Voltage Set Point:14.4V

Replaces

DELCO :
235542

ISKRA :
235542

Unit no.

DELCO

10480403

MERCEDES-BENZ

0001500850

0001501650

A0001500850

A0001501650

Used On

MERCEDES-BENZ

C Class C200 CDI	2000-2007
C-Class C220 CDI	2000-2004
C-Class C270 CDI	2001-2005
CLK 270 CDI	2002-2009
E-Class E200 CDI	1999-2002
E-Class Estate E220T	1999-2003
S-Class S320 CDI	1999-2002

VR-D745

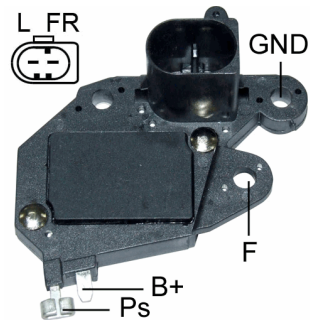

- *L-FR Terminals
- *Soft Start
- *6.0 sec. LRC
- *Short Circuit Protection
- *Voltage Set Point:14.8V

Replaces

DELCO :
236563

Unit no.

DELCO

10480407

MERCEDES-BENZ

0001502450

A0001502450

0001501750

0001502550

A0001501750

A0001502550

VR-D747HD

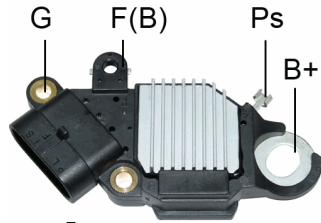

- *Regitar No.:D747HD
- *Soft Start
- *2.5 sec. LRC
- *Short Circuit Protection
- *Voltage Set Point: 14.6V



Replaces

DELCO :
10494747 10458201

Unit no.

DELCO
10480229

VR-D755

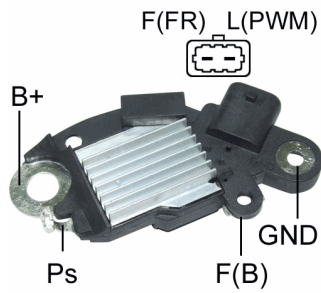

- *Voltage Set Point: 13.8V
- *Soft Start
- *2.5 sec. LRC
- *Short Circuit Protection
- *Regulated Voltage Control(RVC)
- *Requires VR-RVC01 test adaptor for testing

Replaces

DELCO :
10517755

Unit no.

DELCO
10392759 15093928 15200268 15263858 15857608 15905871

TB-ND160

*Terminal Block

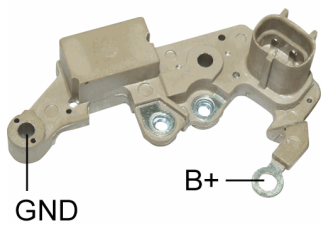

Replaces

DENSO :
126220-0150

Unit no.

DENSO					
121000-3620	121000-3630	121000-3670	121000-3671	121000-4231	121000-4232
121000-4233	121000-4250	121000-4251			

TB-ND163

Terminal Block

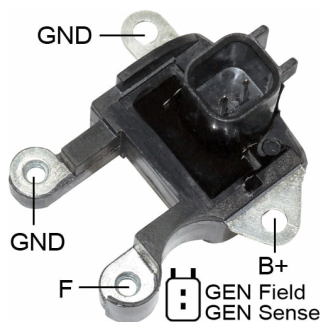

Unit no.

CHRYSLER			
56029700AD	4896805AD	56029914AD	
DENSO			
421000-0470	421000-0620	421000-0590	421000-0591

TB-ND165

*Terminal Block

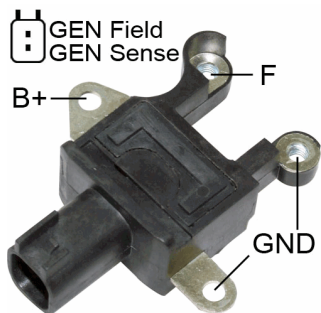

Unit no.

CHRYSLER					
4727865AB	4801304AA	4801311AD	4801480AB		
DENSO					
421000-038	421000-041	421000-048	421000-051	421000-052	421000-054
421000-055	421000-056	421000-066	421000-070		

TB-ND167

*Terminal Block

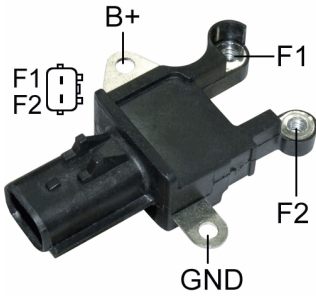

Replaces

DENSO :
126220-0230

Unit no.

DENSO
421000-030

VR-H2005-1

*A-Circuit
*Voltage Set Point:14.4V



Replaces

BOSCH :
0-986-192-017

DENSO :
126000-0030 126000-0060 126000-0100 126000-0101 126000-0120 126000-0140
126000-0141 126000-0310

TOYOTA :
27700-26050 27700-28030 27700-38100 27700-41050 27700-45020 27700-45021

Unit no.

DENSO
021000-0100 021000-0150 021000-0180 021000-0270 021000-0300 021000-0310
021000-6510 021000-6560 021000-7830 021000-8050 100211-0030 100211-0040
100211-0090 100211-0130 100211-0181 100211-0190 100211-0240 100211-0330
100211-0340 100211-0360

TOYOTA
27020-28010 27020-28020 27020-45140 27060-26010 27060-28012 27060-28020
27060-28040 27060-38021 27060-38032 27060-41010 27060-41011 27060-45020
27060-45030 27060-45031 27060-45032 27060-45050 27060-61011 27060-70020

VR-H2005-10

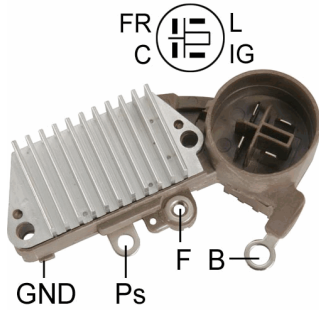

- * 63.5mm Mounting Length
- * C-FR-IG-L Terminals
- * L Terminal Drives Choke
- * W/Capacitor Inside
- * Repair Circuit: VR-H2005-10S
- * Voltage Set Point:14.4V

Replaces

DENSO :

126000-0940	126000-1030	126000-1410	126000-1700	126000-1300	126000-1720
126000-1860	126000-1880				

HONDA :

31150-PM4-003

Unit no.

DENSO

100211-3590	100211-3660	100211-3690	100211-5480	100211-5850	100211-5890
100211-8150	100211-8710	100211-8740			

HONDA

31100-P13-0130	31100-P39-0030	31100-PM5-A01	31100-PM8-A01	31100-PM8-A03	31100-PT3-A51
31100-PT3-A52	CHA-50	CJP-75			

VR-H2005-100

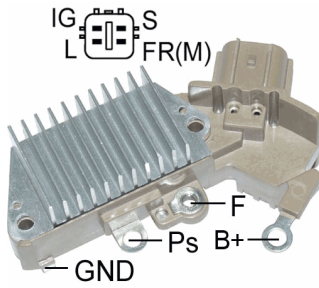

- *IG-S-L-FR Terminals
- *Soft Start
- *6.0 sec. LRC
- *Short Circuit Protection
- *W/Capacitor Inside
- *Voltage Set Point:14.2V
- *Regulation: B-Circuit

* Regulation: B-Circuit

Replaces

DENSO :

126600-0520	126600-0540
-------------	-------------

TOYOTA :

27700-75030	27700-21050
-------------	-------------

Unit no.

DENSO

104210-8230	104210-8110	104210-8590		
27060-75490	27060-75310	27060-75410	27060-75411	27060-75412

Used On

TOYOTA

TACOMA 2.7 4Cyl.	2007-2010
------------------	-----------

VR-H2005-101

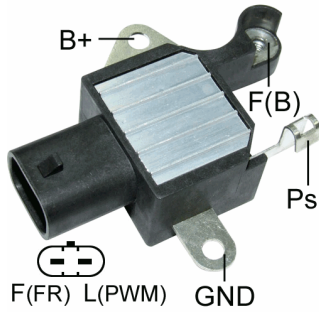

- *Soft Start
- *2.5 sec. LRC
- *Voltage Set Point: 14.8V
- *Regulated Voltage Control(RVC)
- *Requires VR-RVC01 test adaptor for testing

Replaces

DENSO :
126600-3240

Unit no.

DENSO					
104210-3191	104210-3320	104210-4220	104210-4340	104210-4350	104210-4360
104210-4370	104210-4420	104210-4430	104210-6001	104210-6110	104210-6160

VR-H2005-102B

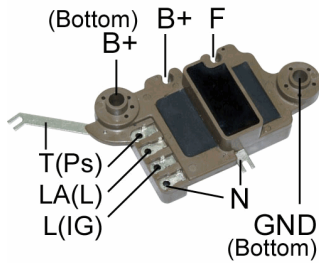

- *24V
- *Voltage Set Point: 28.3V

Unit no.

HINO
27040-1950 27040-1950A
SAWAFUJI
0201-152-0114

VR-H2005-104

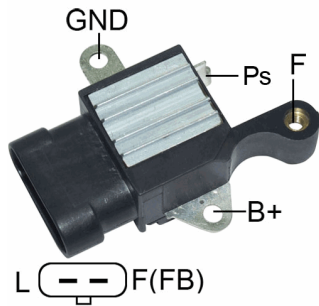

- * L-F Terminals
- * Inactive Lamp
- * Soft Start
- * 2.5 sec. LRC
- * Short Circuit Protection
- * W/Capacitor Inside
- * Voltage Set Point:14.8V

Replaces

DENSO :
126600-0090

Unit no.

DENSO
104210-3280

Used On

GM
Cadillac ATS 3.2L V6 2003-2004

VR-H2005-105

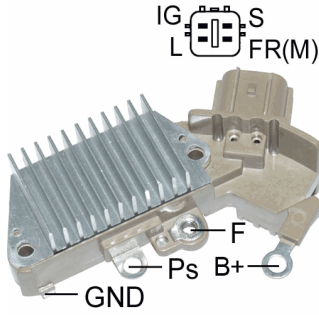

- *IG-S-L-FR Terminals
- *Soft Start
- *8.5 sec. LRC
- *Short Circuit Protection
- *W/Capacitor Inside
- *Voltage Set Point:14.4V

Replaces

DENSO :
126000-3720
TOYOTA :
27700-31040

Unit no.

DENSO
104210-8040
TOYOTA
27060-31010

VR-H2005-11

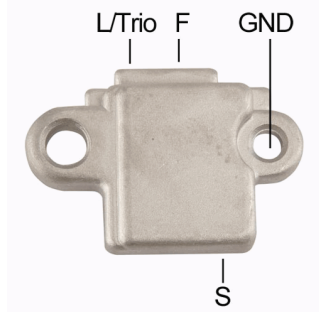

* Voltage Set Point:14.4V

Replaces

BOSCH :
0-986-192-019
DENSO :
126000-0180 126000-0520 126000-0770 126000-0820
TOYOTA :
27700-57060

Unit no.

DENSO
021000-9660 100211-1720 100211-1721 100211-1730 100211-2750 100213-0080
100213-0130 100213-0200 100213-0220 100213-0230 100213-0250 100213-0260
100213-0290 100213-0300 100213-0330 100213-0370 100213-0610 100213-0970
100213-1160 100213-1290
HINO
27050-1170A 27050-1190
TOYOTA
27020-64080 27020-64100 27040-54010 27040-54020 27040-54030 27040-54040
27040-54050 27040-64010 27040-64020 27040-64030 27040-64060

VR-H2005-12

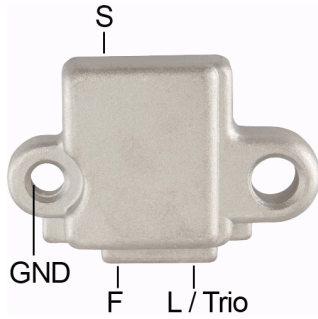

- *24V
- *S-G-F Terminals
- *Voltage Set Point:27.5V

Replaces

DENSO :
126000-0200
TOYOTA :
27700-57050

Unit no.

DENSO
100211-1700 100211-2560 100211-2640

VR-H2005-140

- *Soft Start
- *2.5 sec. LRC
- *Short Circuit Protection
- *Voltage Set Point: 14.4V

Replaces

DENSO :
126000-2650

Unit no.

DENSO
101211-7780 102211-1180

Used On

JOHN DEERE
6081AFM75 8.1L 2004-2007

VR-H2005-142

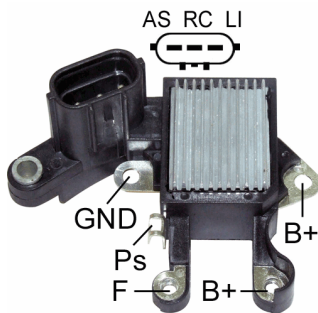

- *Voltage Set Point:14.0V
- *Regulated Voltage Control(RVC)
- *Requires VR-RVC01 test adaptor for testing

Unit no.

LANDROVER
YLE500390

VR-H2005-144

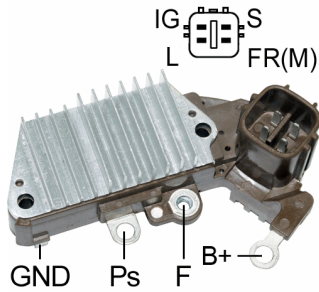

- * IG-S-L-FR Terminals
- * 63.5mm Mounting Length
- * L Terminal Does Not Drive Choke
- * W/Capacitor Inside
- * Voltage Set Point:14.2V

Replaces

DENSO :
126600-0530

Unit no.

TOYOTA
27060-0L071

VR-H2005-146

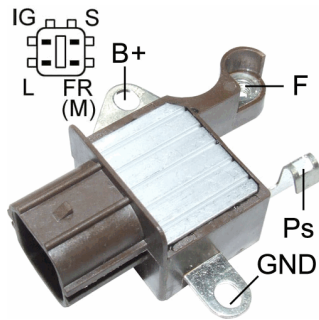

- *IG-S-L-FR Terminals
- *Soft Start
- *W/O LRC
- *Short Circuit Protection
- *Inactive Lamp
- *Voltage Set Point:14.2V

Replaces

DENSO :
126600-3000 126600-3010 126600-3040 126600-3390 236329

Unit no.

DENSO
104210-205 104210-347 104210-420 104210-423 104210-487 104210-4471
TOYOTA
27060-0P140 27060-0P020 27060-0P030 27060-31020 27060-31021 27060-31061
27060-0P141

VR-H2005-148

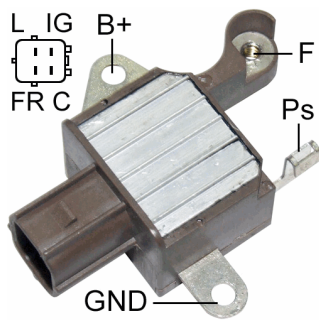

- * Soft Start
- * 8.5 sec. LRC
- * Short Circuit Protection
- * Voltage Set Point:14.4V

Replaces

DENSO :
126600-3660

Unit no.

DENSO
104210-5890
HONDA
31100-R40A01

Used On

HONDA
Accord 2.4L

2008-2010

VR-H2005-149

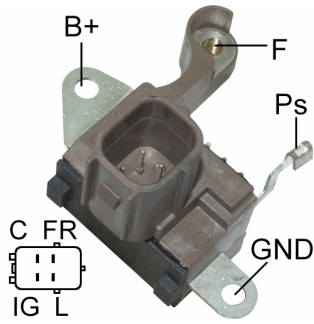

- *Soft Start
- *Short Circuit Protection
- *Voltage Set Point: 14.4V

Replaces

DENSO :
126600-3650

Unit no.

DENSO		
104210-5910	104210-5920	104210-1240
HONDA		
31100-RV0-A01	31100-R70-A01	31100-RGW-A01

Used On

HONDA
Accord 3.5L 2008-2010

VR-H2005-14H

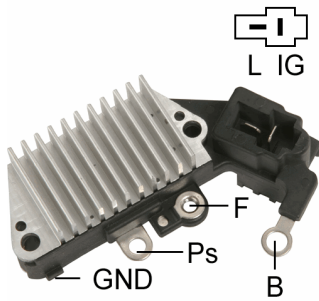

- * L-IG Terminals
- * 63.5mm Mfg. Length
- * L Terminal Drive Choke
- * W/Capacitor Inside
- * Repair Circuit: VR-H2005-5S
- * Voltage Set Point:14.4V

Replaces

DENSO :
126000-0371

Unit no.

DENSO	
100211-1402	100211-1452
TOYOTA	
27060-87701	

VR-H2005-150

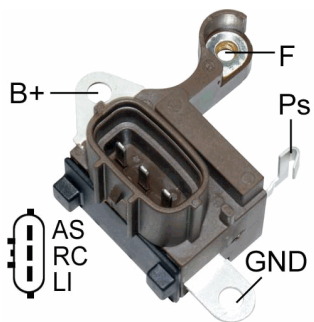

- *Voltage Set Point: 14.0V
- *Regulated Voltage Control(RVC)
- *Requires VR-RVC01 test adaptor for testing

Replaces

DENSO :
126600-3490

Unit no.

DENSO	
104210-3690	104210-3691

VR-H2005-151B

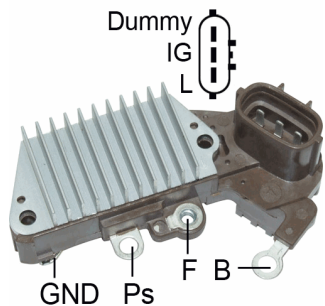

- * Short Circuit Protection
- * Voltage Set Point: 28.3V

Replaces

DENSO :
126000-3730

Unit no.

DENSO
102211-2820 102211-9060

VR-H2005-152

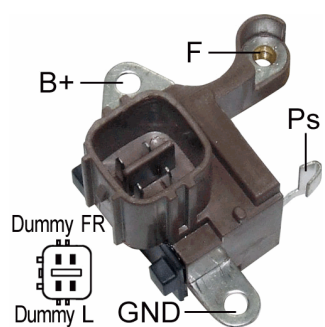

- *Soft Start
- *2.5 sec. LRC
- *Short Circuit Protection
- *Voltage Set Point: 14.4V

Replaces

DENSO :
126600-3080

Unit no.

DENSO
104210-3770
HONDA
31100-RDM-A01

Used On

SATURN
Vue 3.5L

2004-

VR-H2005-154

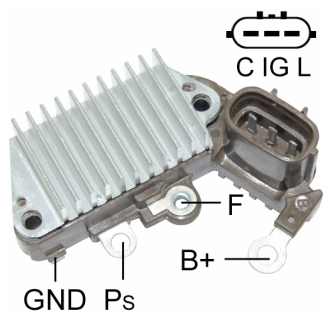

- * C-IG-L Terminals
- * 57.5mm Mounting Length
- * Soft Start
- * 8.5 sec. LRC
- * Short Circuit Protection
- * Voltage Set Point: 14.4V

Replaces

DENSO :
126000-3450

VR-H2005-159

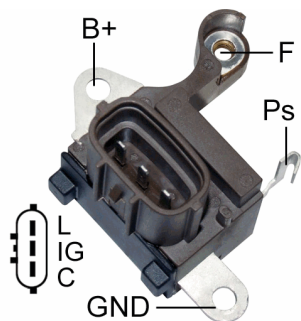

- *Soft Start
- *Short Circuit Protection
- *Voltage Set Point: 14.4V

Unit no.

DENSO
104210-4660
SUZUKI
31400-67J00

VR-H2005-15H

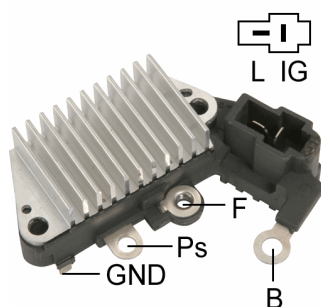

- * L-IG Terminals
- * 57.5mm Mounting Length
- * L Terminal Drives Choke
- * W/Capactor Inside
- * Repair Circuit: VR-H2005-15S
- * Voltage Set Point: 14.4V

Replaces

DENSO :
126000-0970 126000-1160

Unit no.

DENSO
100211-4003 100211-4020
SUBARU
23700-KA060

VR-H2005-162B

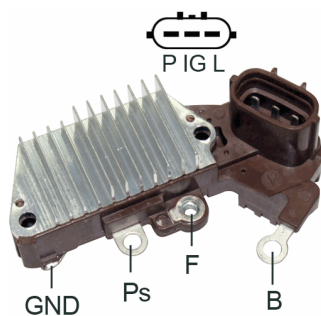

- *24V
- *P-IG-L Terminals
- *63.5mm Mounting Length
- *Voltage Set Point: 28.3V

Replaces

DENSO :
126000-2070

Unit no.

DENSO
101211-7920

VR-H2005-163

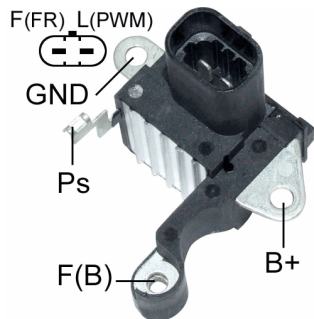

- *Voltage Set Point: 13.8V
- *Soft Start
- *2.5 sec. LRC
- *Short Circuit Protection
- *Regulated Voltage Control(RVC)
- *Requires VR-RVC01 test adaptor for testing

Replaces

DENSO :
126600-3290

Unit no.

DENSO
104210-4560 104210-5070
GM
10335498 15826299

VR-H2005-164A

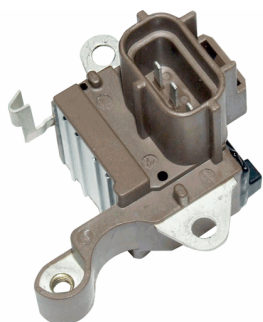

Replaces

DENSO :
126600-0110

Unit no.

DENSO
104210-3201 104210-3202 104210-4150 104210-4910
FORD
3W4T-10300AG 3W4T-10300AH 3W4Z-10346AA 4W4T-10300AA 4W4Z-10346AA 6W4T-10300AA
6W4Z-10346AA

Used On

FORD
Thunderbird 3.9L 2003-2006

VR-H2005-165

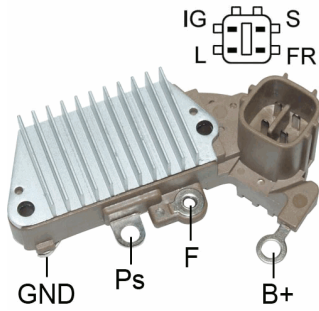

- *IG-S-L-FR Terminals
- *Soft Start
- *8.5 sec. LRC
- *Short Circuit Protection
- *Voltage Set Point:13.9V

Replaces

DENSO :
126000-2890

Unit no.

DENSO
101211-7892

Used On

JAGUAR
S Type 3.0

2000-2004

VR-H2005-166

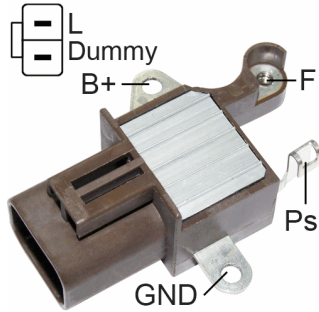

- * Soft Start
- * 2.5 sec. LRC
- * Short Circuit Protection
- * Voltage Set Point:14.4V

Replaces

DENSO :
126600-1890

Unit no.

DENSO
104210-9031
TOYOTA
89736-97161

Used On

ISUZU
D-MAX 3000

VR-H2005-16A

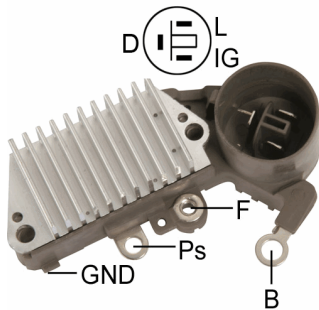

- * D-IG-L Terminals
- * 63.5mm Mounting Length
- * L Terminal Drives Choke
- * Load Response Control
- * Soft Start
- * W/Capacitor Inside
- * Repair Circuit: VR-H2005-16AS
- * Voltage Set Point: 14.4V

Replaces

DENSO :
126000-1200

ISUZU :
8-97032-091-0

VR-H2005-171

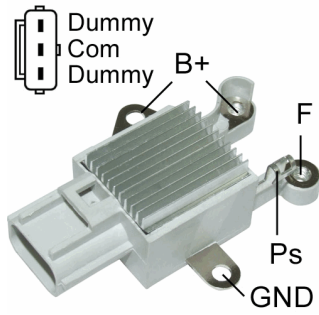

*Voltage Set Point: 13.8V
 *LIN-1 Connections
 *9600 Baud Rate (3 Byte)

Replaces

DENSO :
 126600-7170

Unit no.

DENSO
 104210-4640
 FORD
 3M5T-10300SD

Used On

VOLVO
 C70 2.5L 2006-
 S40 2.5L 2005-2006
 V50 2.4L 2005-2006

VR-H2005-172

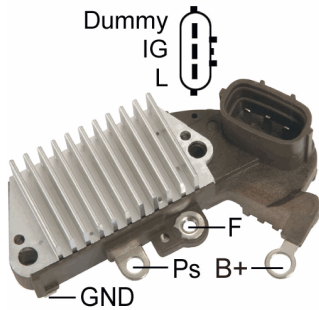

*Soft Start
 *2.5 sec. LRC
 *Voltage Set Point: 14.4V

Unit no.

DENSO
 101211-0530 102211-5020 102211-1430 101211-9340 101211-1860 101211-9880
 SUZUKI
 31400-77E11
 TOYOTA
 27060-75040

VR-H2005-173

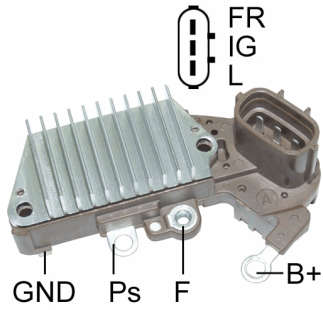

- *Soft Start
- *6.5 sec. LRC
- *Voltage Set Point:14.4V

Replaces

DENSO :
126000-3300

Unit no.

BMW
12317515030
DENSO
102211-2230 102211-2231 102211-2232 102211-2233

Used On

BMW
Mini One 1600 16V 2002-2010
Mini Cooper 1.6L 2007-2008
Mini Cooper 1.6L Turbo 2009-

VR-H2005-176

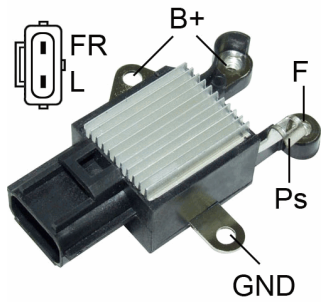

- * Soft Start
- * 2.5 sec. LRC
- * Short Circuit Protection
- * Voltage Set Point:14.4V

Unit no.

DENSO
104210-4050
FORD
3M5T-10300UA
VOLVO
30667051A 8602920 86029200

Used On

VOLVO
S40 L5 2.4L 2004-
S40 L5 2.5L 2004-

VR-H2005-177

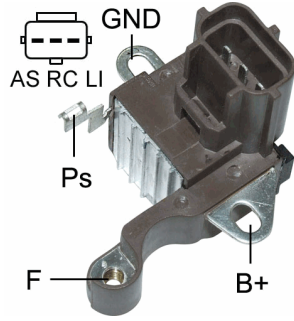

- *Voltage Set Point:14.0V
- *Regulated Voltage Control(RVC)
- *Requires VR-RVC01 test adaptor for testing

Unit no.

DENSO	
104210-2021	104210-5850
FORD	
9L2Z-10346A	9R3Z-10346D

Used On

FORD	
Explorer V8 4.6L	2009-2010
Explorer Sport Trac V8 4.6L	2009-2010
Mustang V8 4.6L	2009-2010

VR-H2005-179

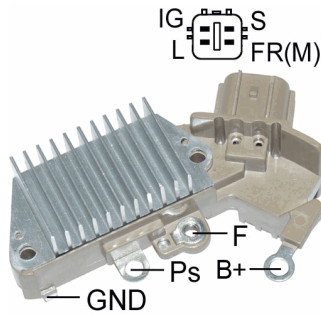

- *IG-S-L-FR Terminals
- *Soft Start
- *8.5 sec. LRC
- *Short Circuit Protection
- *Voltage Set Point:14.2V

Replaces

DENSO :
126000-3020
TOYOTA :
27700-27070

Unit no.

DENSO	
102211-0750	
TOYOTA	
27060-28070	

VR-H2005-17A

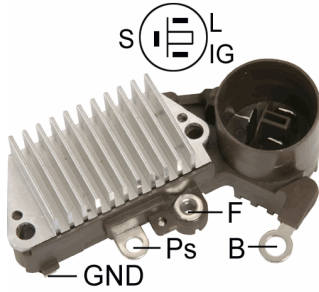

- * S-IG-L Terminals
- * 63.5mm Mounting Length
- * L Terminal Drives Choke
- * Load Response Control
- * Soft Start
- * W/Capacitor Inside
- * Repair Circuit: VR-H2005-17AS
- * Voltage Set Point: 14.4V

Replaces

DENSO :

126000-1400

TOYOTA :

27700-70030

Unit no.

DENSO

100211-3050	100211-3240	100211-3391	100211-3500	100211-3520	100211-3680
100211-7130	100211-7140	100211-7440	100211-7450	100211-8030	100211-8050
100211-8070	100211-8090	100211-8350	100211-8640	100211-9700	

TOYOTA

27060-03010	27060-10011	27060-11020	27060-11030	27060-11060	27060-11220
27060-16131	27060-16230	27060-16260	27060-42030	27060-55011	27060-55030
27060-55050	27060-62040	27060-72062	27060-72071	27060-72150	27060-72171
27060-72180	27060-74080	27060-75050			

VR-H2005-18A

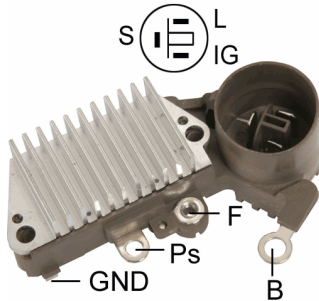

- * S-IG-L Terminals
- * 63.5mm Mounting Length
- * L Terminal Does Not Drive Choke
- * Soft Start
- * Load Response Control
- * W/Capacitor Inside
- * Repair Circuit: VR-H2005-18AS
- * Voltage Set Point: 14.4V

Replaces

DENSO :

126000-1260 126000-1270 126000-1190 126000-1400 126000-1500

TOYOTA :

27700-46030 27700-46040 27700-72090

Unit no.

DENSO

100211-5360	100211-6180	100211-6300	100211-6330	100211-6340	100211-6360
100211-7910	100211-7930				

VR-H2005-19A

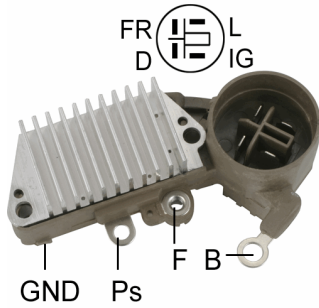

- * D-FR-IG-L Terminals
- * 63.5mm Mounting Length
- * L Terminal Drives Choke
- * Load Response Control
- * Soft Start
- * W/Capacitor Inside
- * Repair Circuit: VR-H2005-19AS
- * Voltage Set Point:14.4V

Replaces

DENSO :
126000-1470

Unit no.

DENSO
100211-8910 100211-9100
HONDA
31100-PR4-C01

VR-H2005-2

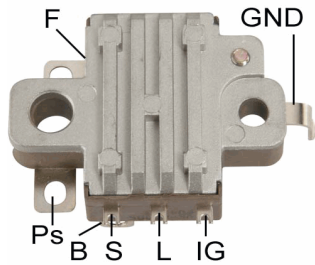

- * W/Capacitor Inside
- * Voltage Set Point:14.4V

Replaces

DENSO :
126000-0920 126000-1460
TOYOTA :
27000-64040 27700-64110

Unit no.

DENSO
100213-0750 100213-0760 100213-0950 100213-0980 100213-1120 100213-1210
100213-1450 100213-1500
TOYOTA
27040-64070 27040-64080 27040-64110 27040-64130 27040-64131 27040-64140
27040-64141

VR-H2005-22

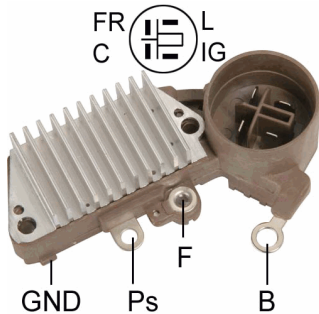

- * C-FR-IG-L Terminals
- * 63.5mm Mounting Length
- * L Terminal Does Not Drive Choke
- * W/Capacitor Inside
- * Repair Circuit: VR-H2005-22S
- * Voltage Set Point:14.4V

Replaces

DENSO :
126000-1360

Unit no.

DENSO
120011-8601

VR-H2005-23A

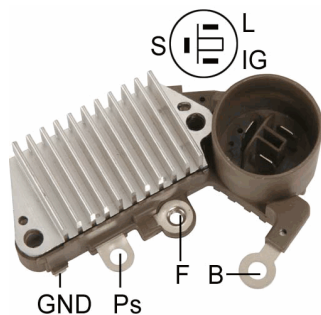

- * S-IG-L Terminals
- * 57.5mm Mounting Length
- * L Terminal Drives Choke
- * Soft Start
- * Load Response Control
- * W/Capacitor Inside
- * Repair Circuit: VR-H2005-23AS
- * Voltage Set Point:14.4V

Replaces

DENSO :

126000-0550 126000-0980 126000-0900 126000-0901 126000-1550 126000-1570

LUCAS :

UCJ423

MAGNETI MARELLI :

940038087

TOYOTA :

27700-10050 27700-10080

Unit no.

DENSO

100211-1520 100211-1560 100211-1620 100211-4160 100211-4170 100211-4290

100211-4320 100211-4350 100211-4410 100211-6860

TOYOTA

27060-10070 27060-10071 27060-10100 27060-11080 27060-72080 27060-72081

27060-72140

VR-H2005-24

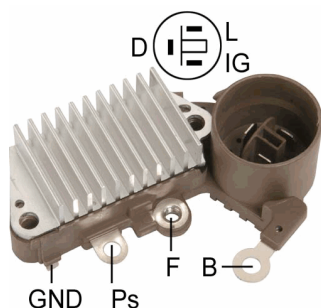

- * D-IG-L Terminals
- * 57.5mm Mounting Length
- * L Terminal Drives Choke
- * W/Capacitor Inside
- * Repair Circuit: VR-H2005-15S
- * Voltage Set Point:14.4V

Replaces

DENSO :

126000-0850 126000-0880

ISUZU :

8-94455-160

Unit no.

DENSO

100211-4130 100211-4260 100211-6600 100211-6720

ISUZU

8-94449-781-0

SUZUKI

31400-60B40

VR-H2005-25

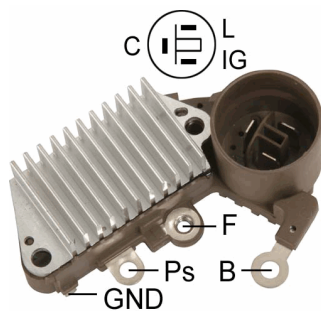

- * C-IG-L Terminals
- * 57.5mm Mounting Length
- * L Terminal Drives Choke
- * W/Capacitor Inside
- * Repair Circuit: VR-H2005-25S
- * Voltage Set Point:14.4V

Replaces

DENSO :
126000-0840

Unit no.

DENSO
100211-4150 100211-4110
GM
96056770
SUZUKI
31400-86210

VR-H2005-26A

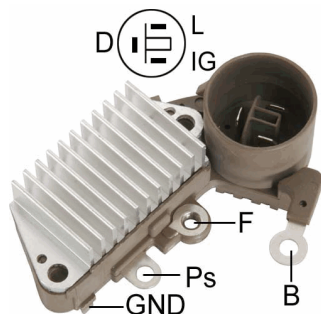

- * D-IG-L Terminals
- * 57.5mm Mounting Length
- * L Terminal Does Not Drive Choke
- * W/Capacitor Inside
- * Repair Circuit: VR-H2005-26AS
- * Voltage Set Point:14.4V

Replaces

DENSO :
126000-0721 126000-0950 126000-1330 126000-2120 126000-2720 126000-2810
126000-0720

ISUZU :
8-94455160-0

SUZUKI :
32500-86511

Unit no.

DENSO
100211-1550 100211-1570 100211-6720
SUZUKI
31400-60840 31400-86010 31400-86510

VR-H2005-28

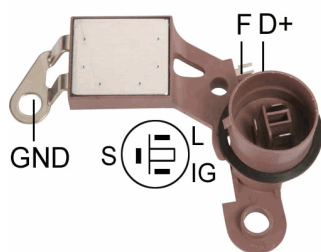

- * S-IG-L Terminals
- * Repair Circuit: VR-H2005-3S
- * Voltage Set Point:14.4V

Replaces

DENSO :

126000-0360 126000-0460 126000-0500 126000-0670

Unit no.

DENSO

100211-0680 100211-0730 100211-0760 100211-0780 100211-0870 100211-0930

100211-2570 100211-2630 100211-2980 100211-2990 100211-5760 100211-5930

HINO

27040-1240A 27040-1261A

TOYOTA

27060-16030 27060-61090 27060-63010 27060-63070 27060-72020 27060-72030

27060-72040

VR-H2005-29

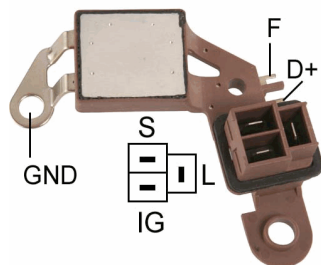

- * L-S-IG Terminals
- * Repair Circuit: VR-H2005-3S
- * Voltage Set Point:14.4V

Replaces

DENSO :

126000-0270

ISUZU :

8-94239-079-0

Unit no.

DENSO

100211-0581 100211-0990

KUBOTA

15451-99371

VR-H2005-2W

* W/Capacitor Inside
 * Voltage Set Point:14.4V

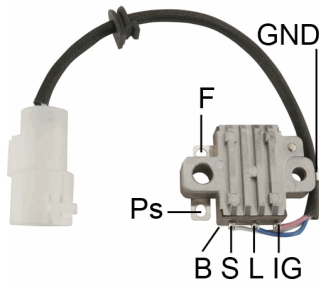

Replaces

DENSO :
 126000-0920 126000-1460
TOYOTA :
 27000-64040

Unit no.

DENSO					
100213-0750	100213-0760	100213-0950	100213-0980	100213-1120	100213-1210
100213-1450	100213-1500				
TOYOTA					
27040-64070	27040-64080	27040-64110	27040-64130	27040-64131	27040-64140
27040-64141					

VR-H2005-3

* S-IG-L Terminals
 * Repair Circuit:VR-H2005-3S
 * Voltage Set Point:14.4V

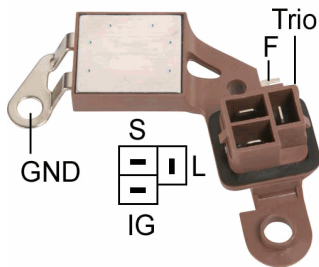

Replaces

BOSCH :
 0-986-192-023
DENSO :
 126000-0170 126000-0450 126000-0490 126000-1809
TOYOTA :
 27700-43010 27700-44040

Unit no.

DENSO					
100211-0270	100211-0500	100211-0530	100211-0540	100211-0550	100211-0560
100211-0590	100211-0600	100211-0610	100211-0620	100211-0630	100211-0640
100211-0650	100211-0660	100211-0670	100211-0680	100211-0700	100211-0710
100211-0750					
TOYOTA					
27020-16010	27020-16030	27020-16040	27020-43060	27060-10030	27060-15011
27060-28030	27060-28050	27060-34020	27060-34030	27060-34040	27060-43010
27060-43020	27060-43030	27060-43040	27060-43060	27060-43070	27060-43080
27060-43090	27060-44010	27060-63010	27060-70040	27060-70060	27060-70062

VR-H2005-30A

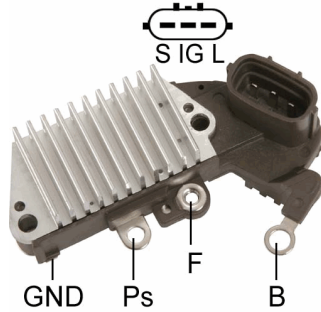

- * S-IG-L Terminals
- * 63.5mm Mounting Length
- * L Terminal Drive Choke
- * Load Response Control
- * Soft Start
- * W/Capacitor Inside
- * Repair Circuit: VR-H2005-17AS
- * Voltage Set Point:14.4V

Replaces

DENSO :

126000-1960	126000-2050	126000-2200	126000-2230	126000-2250	126000-1730
126000-1750	126000-1930				

TOYOTA :

27700-11070	27700-66040	27700-50020	27700-50030	27700-54060	27700-74040
-------------	-------------	-------------	-------------	-------------	-------------

Unit no.

DENSO

101211-0100	101211-0190	101211-0340	101211-0350	101211-0430	101211-0450
101211-0520	101211-5080	101211-5150	101211-5160		

TOYOTA

27060-02050	27060-02070	27060-11270	27060-11280	27060-11290	27060-11300
27060-11320	27060-15100	27060-15110	27060-35150	27060-62090	27060-66040
27060-74460	27060-75100				

VR-H2005-31A

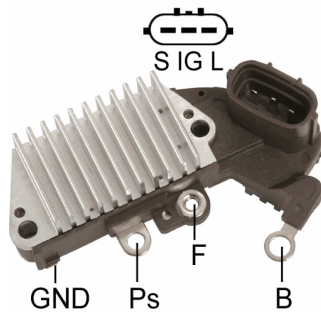

- * S-IG-L Terminals
- * 63.5mm Mounting Length
- * L Terminal Does Not Drive Choke
- * Soft Start
- * Load Response Control
- * W/Capacitor Inside
- * Repair Circuit: VR-H2005-18AS
- * Voltage Set Point:14.4V

Replaces

DENSO :

126000-1540	126000-1670	126000-2290	126000-7100	126000-7110	126000-1580
126000-1640	126000-1660				

TOYOTA :

27700-35040	27700-74030	27700-40050	27700-65010	27700-75030	
-------------	-------------	-------------	-------------	-------------	--

Unit no.

DENSO

100211-0050	100211-5020	100211-5110	100211-6460	100211-6480	101211-0060
101211-0070	101211-0140	101211-0210	101211-0270	101211-0380	101211-0390
101211-5000	101211-5010	101211-5120	101211-5130	101211-5170	101211-5370
101211-5380	101211-5460	101211-5550	101211-5640	101211-5660	101211-5720
101211-5750	101211-5760	101211-5770	101211-5900	101211-5970	101211-7010
101211-7060	101211-7100	101211-7510			

TOYOTA

27060-11281	27060-15080	27060-15090	27060-15150	27060-16320	27060-16330
27060-16340	27060-17160	27060-17180	27060-50090	27060-50100	27060-55070
27060-55080	27060-62080	27060-64100	27060-64130	27060-64150	27060-64190
27060-64200	27060-65050	27060-70410	27060-70430	27060-72350	27060-72360
27060-72370	27060-74360	27060-74370	27060-74430	27060-74440	27060-75110
27060-75120	27060-76180				

VR-H2005-32A

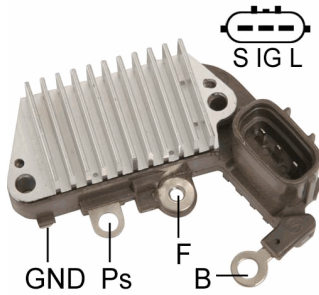

- * S-IG-L Terminals
- * 57.5mm Mounting Length
- * L Terminal Drives Choke
- * Load Response Control
- * Soft Start
- * W/Capacitor Inside
- * Repair Circuit: VR-H2005-32AS
- * Voltage Set Point:14.4V

Replaces

DENSO :
126000-1630 126000-959

TOYOTA :
27700-11060

Unit no.

DENSO
100211-2130
TOYOTA
27060-11250

VR-H2005-33A

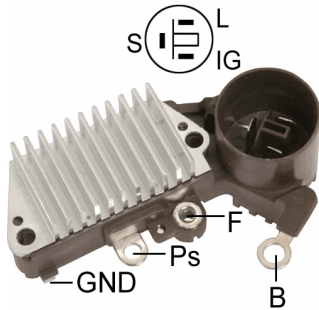

- * S-IG-L Terminals
- * 63.5mm Mounting Length
- * L Terminal Does Not Drive Choke
- * Soft Start
- * W/Capacitor Inside
- * Repair Circuit: VR-H2005-33AS
- * Voltage Set Point:14.4V

Replaces

DENSO :
126000-0610 126000-1110

TOYOTA :
27700-74010

Unit no.

DENSO
100211-5210 100211-6110 100211-7470 100211-7780 100211-7960 100211-8380
100211-8450 100211-8470 100211-8480 100211-8500 100211-8590

TOYOTA
27060-46010 27060-46020 27060-62050 27060-65030 27060-74090 27060-74170
27060-74180 27060-74190 27060-74210 27060-74220 27060-74240 27060-74280
27060-74281

VR-H2005-34

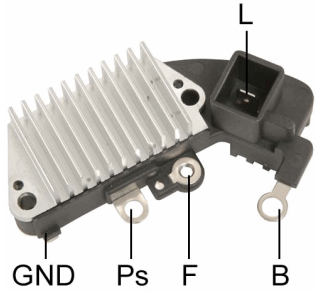

- * L Terminal
- * 63.5mm Mounting Length
- * L Terminal Drives Choke.
- * W/Capacitor Inside
- * Repair Circuit: VR-H2005-34S
- * Voltage Set Point:14.4V

Replaces

DENSO :

126000-1130 126000-1760 126000-7160

Unit no.

DENSO

100211-8370 100211-8620 100211-8630

VR-H2005-35

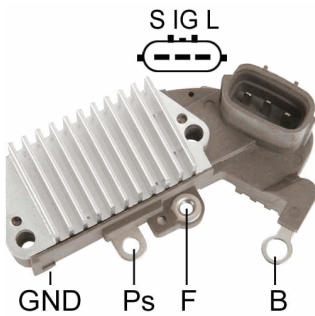

- * S-IG-L Terminals
- * 63.5mm Mounting Length
- * L Terminal Does Not Drive Choke
- * W/Capacitor Inside
- * Repair Circuit: VR-H2005-35S
- * Voltage Set Point:14.6V

Replaces

DENSO :

126000-7100

Unit no.

DENSO

101211-0130 101211-0300 101211-7010

VR-H2005-36A

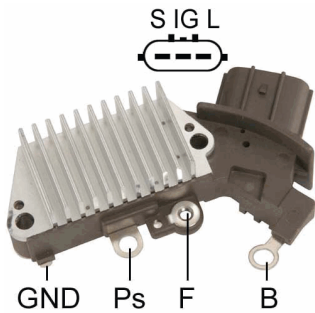

- * S-IG-L Terminals
- * 63.5mm Mounting Length
- * L Terminal Drives Choke
- * Load Response Control
- * Soft Start
- * W/Capacitor Inside
- * Repair Circuit: VR-H2005-17AS
- * Voltage Set Point:14.4V

Unit no.

DENSO

100211-5620

VR-H2005-37A



- * L Terminal Drives Choke
- * Soft Start
- * 8.5 sec. LRC
- * W/Capacitor Inside
- * Voltage Set Point:14.4V

Replaces

BOSCH :

0-986-192-024

DENSO :

126000-0300 126000-0301 126000-0302 126000-0420

HONDA :

31400-SA5-004 31400-SA5-671 31400-SA5-A0300 31400-SB0-004

Unit no.

DENSO

021000-977 021000-983

HONDA

31100-PC1-004 31100-PC1-020 31100-PC1-971

VR-H2005-39

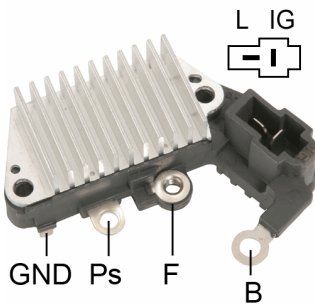

- * L-IG Terminals
- * 57.5mm Mounting Length
- * L Terminal Does Not Drive Choke
- * W/Capacitor Inside
- * Repair Circuit: VR-H2005-26S
- * Voltage Set Point:14.4V

Replaces

DAIHATSU :

27700-87207 27700-96301

DENSO :

126000-0600

ISEKI :

281-271-001-0

TOYOTA :

27700-78301

Unit no.

DENSO

100211-1550 100211-1670 100211-1680

ISHIKAWAJIMA

18504-6220

MITSUBISHI MOTORS

MD604589

VR-H2005-39SE

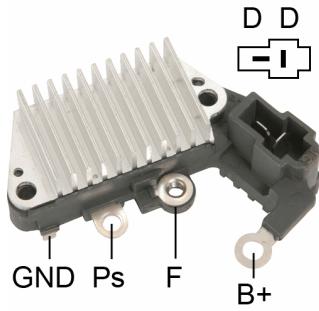

- * 57.5mm Mounting Length
- * L Terminal Does Not Drive Choke
- * Self Exciting
- * W/Capacitor Inside
- * Voltage Set Point:14.6V

Replaces

DENSO :

126000-0600 126000-0760 126000-1160

Unit no.

DENSO

100211-1511	100211-1540	100211-1550	100211-1580	100211-1590	100211-1610
100211-1630	100211-1650	100211-1662	100211-1670	100211-1680	100211-1690
100211-4050	100211-4060	100211-4080	100211-4091	100211-4180	100211-4200
100211-4210	100211-4220	100211-4230	100211-4240	100211-4250	100211-4360
100211-4382	100211-4460	100211-4482	100211-4520	100211-4550	100211-4560
100211-4700	100211-6221	100211-6640	100211-6760	100211-6770	100211-6880
100211-6890	100211-6900	100211-6920			

VR-H2005-40

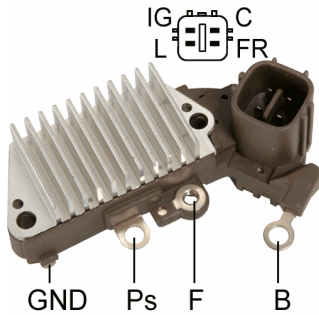

- * IG-C-L-FR Terminals
- * 63.5mm Mounting Length
- *Soft Start
- * 2.5 Sec. LRC
- * Short Circuit Protection
- * L Terminal Does Not Drive Choke
- * W/0.47µF Capacitor Inside
- * Repair Circuit: VR-H2005-22S
- * Voltage Set Point:14.4V

Replaces

DENSO :

126000-2090 126000-2160 126000-2170 126000-2470 126000-2610

HONDA :

31150-P2T-0030

MAGNETI MARELLI :

940038097

Unit no.

DENSO

101211-9380	101211-9390	101211-9820	102211-1260
-------------	-------------	-------------	-------------

VR-H2005-40A

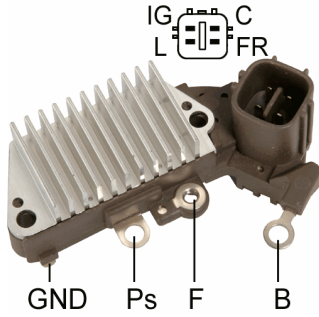

- * IG-C-L-FR Terminals
- * 63.5mm Mounting Length
- * Soft Start
- * 2.5 sec. LRC
- * Short Circuit Protection
- * L Terminal Does Not Drive Choke
- * W/ 2.7 μ F Capacitor Outside
- * Voltage Set Point: 15.1V

Replaces

DENSO :
126000-3430

Unit no.

DENSO
102211-086 102211-087
JAGUAR
XR822418

VR-H2005-40T

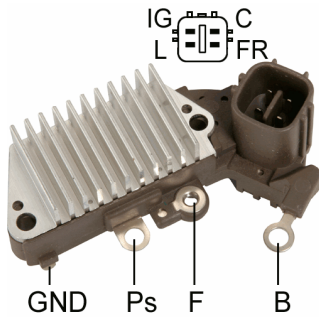

*Same as VR-H2005-40 w/choke function

VR-H2005-45A

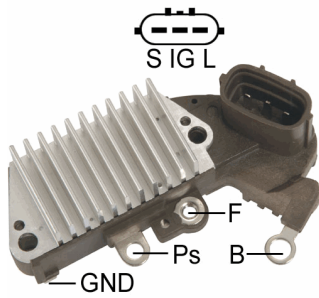

- * S-IG-L Terminals
- * 63.5mm Mounting Length
- * L Terminal Drive Choke
- * Soft Start
- * Load Response Control
- * W/Capacitor Inside
- * Repair Circuit: VR-H2005-4AS
- * Voltage Set Point:14.4V

Replaces

DENSO :
126000-1520 126000-1521

VR-H2005-46A

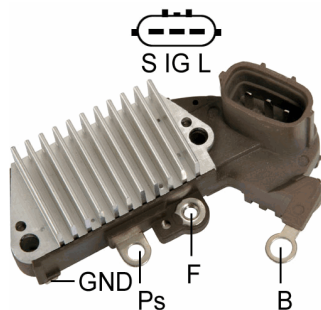

- * S-IG-L Terminals
- * 63.5mm Mounting Length
- * L Terminal Does Not Drive Choke
- * Soft Start
- * W/Capacitor Inside
- * Repair Circuit: VR-H2005-33AS
- * Voltage Set Point:14.4V

Replaces

DENSO :

126000-1670	126000-2050	126000-2200	126000-2230	126000-7100
-------------	-------------	-------------	-------------	-------------

Unit no.

DENSO

101211-0300	101211-7300	101211-7301	101211-7760	101211-7761
-------------	-------------	-------------	-------------	-------------

VR-H2005-48A

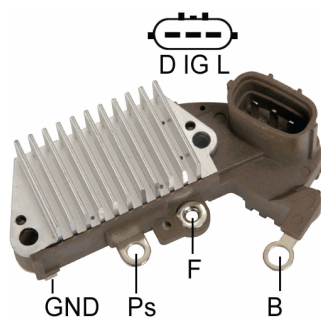

- * D-IG-L Terminals
- * 63.5mm Mounting Length
- * L Terminal Does Not Drive Choke
- * Soft Start
- * Load Response Control
- * W/Capacitor Inside
- * Repair Circuit: VR-H2005-48AS
- * Voltage Set Point:14.4V

Replaces

DENSO :

126000-1920	126000-1970	126000-1971	126000-1977	126000-2680	126000-2740
126000-3060	126000-3530				

Unit no.

DENSO

101211-0550	101211-0720	102211-5070
-------------	-------------	-------------

SUZUKI

31400-60G11	31400-60G12
-------------	-------------

VR-H2005-4A

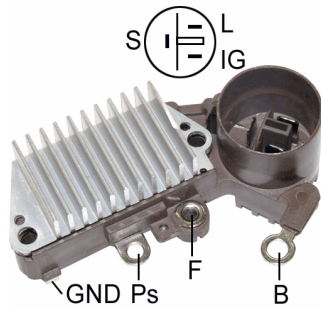

- * S-IG-L Terminals
- * 63.5mm Mounting Length
- * L Terminal Drives Choke
- * Soft Start
- * W/Capacitor Inside
- * Repair Circuit: VR-H2005-4AS
- * Voltage Set Point:14.4V

Replaces

BOSCH :

0-986-192-021

DENSO :

126000-0340	126000-0510	126000-0650	126000-0700	126000-1530	126000-0330
126000-0400	126000-0731	126000-0732	126000-0931	126000-0932	126000-1010
126000-1450	126000-1560	126000-7090			

GM :

94139012 94840314

HONDA :

31150-PD1-004 31150-PD2-004 31150-PDJ-004

ISUZU :

8-9413-053-0

LUCAS :

UCB412

TOYOTA :

27700-01010	27700-63021	27700-72070	27700-10061	27700-11030	27700-11050
27700-54050	27700-63020	27700-70030	27700-72040	27700-72041	

Unit no.

DENSO

100211-1000	100211-1001	100211-1011	100211-1021	100211-1031	100211-1040
100211-1041	100211-1050	100211-1060	100211-1061	100211-1070	100211-1074
100211-1080	100211-1090	100211-1091	100211-1110	100211-1131	100211-1141
100211-1180	100211-1200	100211-1210	100211-1220	100211-1230	100211-1320
100211-1340	100211-1360	100211-2020	100211-2030	100211-2050	100211-2060
100211-2070	100211-2100	100211-2150	100211-2170	100211-2210	100211-2250
100211-2280	100211-2370	100211-2380	100211-2400	100211-2500	100211-2830
100211-2840	100211-3030	100211-3040	100211-3060	100211-3090	100211-3110
100211-3150	100211-3180	100211-3220	100211-3260	100211-3300	100211-3320
100211-3350	100211-3390	100211-3430	100211-3500	100211-3510	100211-3520
100211-3530	100211-3540	100211-3550	100211-3610	100211-3630	100211-3770
100211-3820	100211-3960	100211-7000	100211-7050	100211-7060	100211-7460
100211-7570	100211-7800	100211-7970	100211-8300	100211-8540	100211-9710

HONDA

31100-PD1-014	31100-PD1-024	31100-PD2-004	31100-PD2-014	31100-PD2-024	31100-PD2-970
31100-PD2-973	31100-PE0-003	31100-PE0-921	31100-PE2-003	31100-PH1-004	31100-PH1-014
31100-PH1-024	31100-PK1-004				

ISUZU

8-94109-911-5 8-94120-564-4 8-94131-357-2 8-94408-674-0

TOYOTA

27040-64040	27040-64050	27060-10010	27060-10011	27060-13090	27060-15040
27060-16010	27060-16012	27060-16040	27060-16050	27060-16080	27060-16082
27060-16091	27060-16122	27060-16131	27060-16140	27060-16160	27060-16170
27060-35060	27060-42030	27060-43060	27060-43062	27060-43110	27060-43111
27060-43130	27060-43140	27060-63020	27060-63021	27060-63030	27060-63040
27060-63041	27060-63080	27060-63082	27060-63100	27060-63101	27060-63102
27060-72010	27060-72050	27060-72060	27060-72061	27060-72070	27060-72071
27060-72100	27060-72101	27060-74101	27060-16090		

VR-H2005-50A

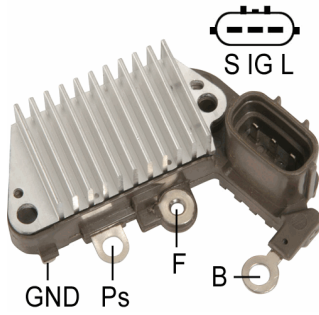

- * S-IG-L Terminals
- * 57.5mm Mounting Length
- * L Terminal Drives Choke
- * Load Response Control
- * Soft Start
- * W/Capacitor Inside
- * Voltage Set Point:14.4V

Replaces

DENSO :
126000-1740

VR-H2005-52A

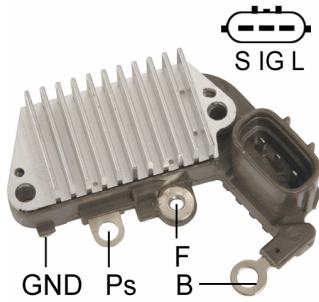

- * S-IG-L Terminals
- * 57.5mm Mounting Length
- * L Terminal Does Not Drive Choke
- * Load Response Control
- * Soft Start
- * W/Capacitor Inside
- * Voltage Set Point:14.4V

Replaces

DENSO :
126000-2400

Unit no.

DENSO
101211-373 101211-858

VR-H2005-58

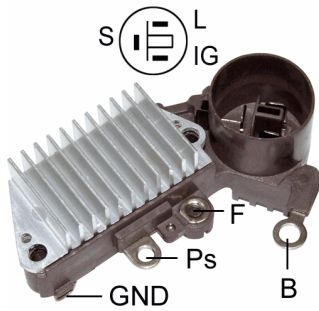

- * 24V
- * S-IG-L Terminals
- * L Terminal Does Not Drive Choke
- * W/Capacitor Inside
- * 63.5mm Mounting Length
- * Voltage Set Point:28.3V

Replaces

DENSO :
126000-7010 126000-7011 126000-2340

TOYOTA :
27700-58020

Unit no.

DENSO
100211-6200 100211-6210 100211-6221

VR-H2005-59

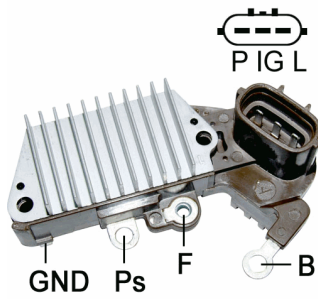

- * P-IG-L Terminals
- * W/Capacitor Inside
- * 63.5mm Mounting Length
- * Voltage Set Point:14.4V

Replaces

DENSO :
126000-1940

Unit no.

DENSO
101211-9010 101211-9020 101211-9940

VR-H2005-5H

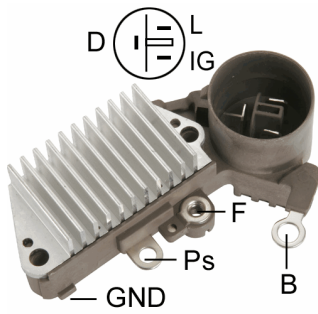

- * D-IG-L Terminals
- * 63.5mm Mounting Length
- * L Terminal Drives Choke
- * W/Capacitor Inside
- * Repair Circuit:VR-H2005-5S
- * Voltage Set Point:14.4V

Replaces

DENSO :
126000-0430

ISUZU :
8-94139-012-0

Unit no.

DENSO
100211-1270 100211-1271 100211-1331 100211-1371 100211-1380

ISUZU
8-94137-345-2

VR-H2005-60

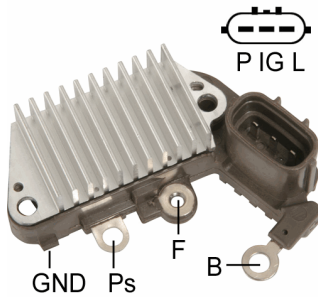

- * P-IG-L Terminals
- * Soft Start
- * 2.5 sec. LRC
- * W/Capacitor Inside
- * 57.5mm Mounting Length
- * Voltage Set Point:14.4V

Replaces

DENSO :
126000-1800

Unit no.

DENSO
101211-2310

VR-H2005-62A

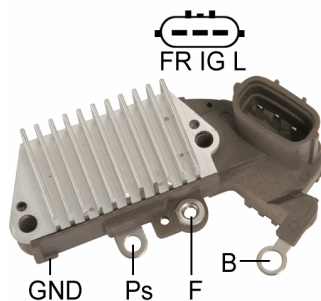

- * FR-IG-L Terminals
- * Soft Start
- * 2.5 sec. LRC
- * Short Circuit Protection
- * W/Capacitor Inside
- * 63.5mm Mounting Length
- * L Terminal Does Not Drive Choke
- * Repair Circuits:VR-H2005-62AS
- * Voltage Set Point:14.4V

Replaces

DENSO :

126000-3040 126000-2861

Unit no.

DENSO

102211-1860 102211-9820 102211-9880 102211-5210 102211-5250 102211-5410

HONDA

31100-P2E-G01 31100-P7F-00331

TOYOTA

27060-23010 27060-23070

VR-H2005-63A

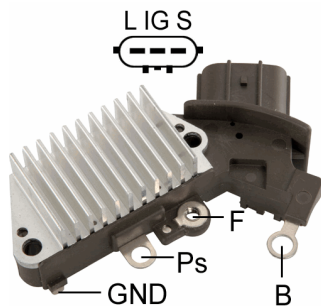

- * S-IG-L Terminals
- * 63.5mm Mfg. Length
- * L Terminal Does Not Drive Choke
- * Load Response Control
- * Soft Start
- * 8.5 sec. LRC
- * W/Capacitor Inside
- * Voltage Set Point:14.4V

Replaces

DENSO :

126000-1870 126000-2260

TOYOTA :

27700-20050 27700-46060 27700-62010 27700-64130

VR-H2005-64A

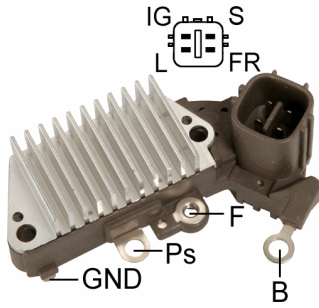

- * IG-S-L-FR Terminals
- * 63.5mm Mfg.Length
- * L Terminal Does Not Drive Choke
- * Load Response Control
- * Soft Start
- * W/Capacitor Inside
- * Repair Circuit:VR-H2005-64AS
- * Voltage Set Point:14.4V

Replaces

DENSO :

126000-2190 126000-3690

TOYOTA :

27700-50040

Unit no.

DENSO

102211-2310	102211-2810	104210-4460	104210-8020	104210-8240	104210 -8241
104210 -9010	104210-9011	104210-9340.	104210-800	104210-801	101211-7230
101211-7270					

HONDA

31100-P5A-003

TOYOTA

27060-50300	27060-62240	27060-0L020	27060-0L021	27060 -0L030	27060-0L040
27060-30010	27060-30040	27060-30050	27060-30080	27060-30120	27060-30150
27060-30151					

VR-H2005-65

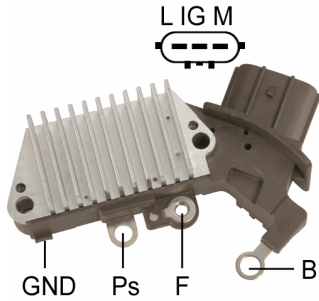

- * M-IG-L Terminals
- * 63.5mm Mounting Length
- * L Terminal Does Not Drive Choke
- * Load Response Control
- * Soft Start
- * W/Capacitor Inside
- * Voltage Setting:14.4V

Replaces

DENSO :

126000-3170 126000-3171

TOYOTA :

27700-21020

Unit no.

DENSO

100211-5380 100211-5480

VR-H2005-66

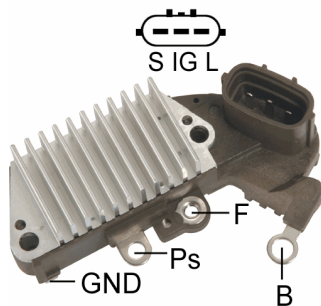

- * S-IG-L Terminals
- * W/Capacitor Inside
- * L Terminal Does Not Drive Choke
- * 63.5mm Mounting Length
- * Voltage Set Point:28.3V

Replaces

DENSO :
126000-7120

TOYOTA :
27700-58040

Unit no.

DENSO			
100211-6240	100211-6250	100211-6260	
TOYOTA			
27060-17120	27060-58150	27060-58230	27060-58250

VR-H2005-6H

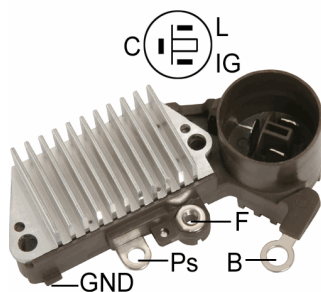

- * C-IG-L Terminals
- * 63.5mm Mounting Length
- * Soft Start
- * 2.5 sec. LRC
- * L Terminal Drives Choke
- * W/Capacitor Inside
- * Repair Circuit:VR-H2005-6S
- * Voltage Set Point:14.4V

Replaces

DENSO :
126000-0440

HONDA :
31150-PE0-921

Unit no.

DENSO
100211-1260
HONDA
31100-PE0-924

VR-H2005-77

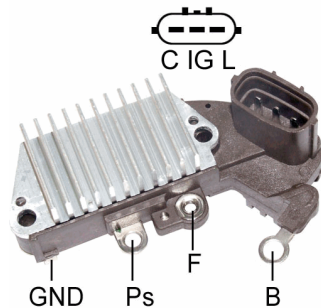

- * C-IG-L Terminals
- * 63.5mm Mounting Length
- * L Terminal Drives Choke
- * W/Capacitor Inside
- * Voltage Set Point: 14.4V

Replaces

DENSO :

126000-2150 126000-2151

ISUZU :

8-97122796-0

Unit no.

DENSO

101211-4220

ISUZU

29012-37800 29012-37801 89710-97800 89710-97801

VR-H2005-7A

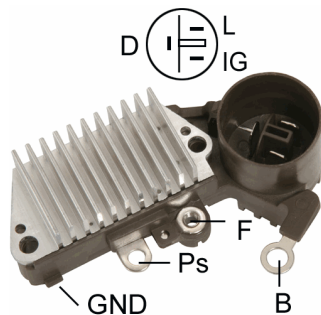

- * D-IG-L Terminals
- * 63.5mm Mounting Length
- * L Terminal Does Not Drive Choke
- * W/Capacitor Inside
- * Repair Circuit: VR-H2005-7S
- * Voltage Set Point: 14.4V

Replaces

BOSCH :

0-986-192-022

DENSO :

126000-0410 126000-0411 126000-0470

GM :

96052000

HONDA :

31150-PE0-003

MAGNETI MARELLI :

943241001 MSR1001

SUZUKI :

32500-82610

Unit no.

DENSO

100211-1400 100211-1411

SUZUKI

9605-1973 9605-4116

VR-H2005-8

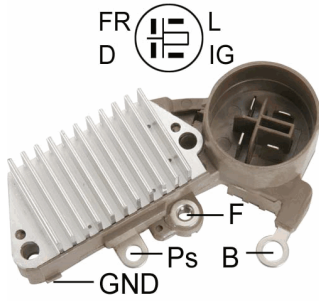

- * D-FR-IG-L Terminals
- * 63.5mm Mounting Length
- * L Terminal Drives Choke
- * W/Capacitor Inside
- * Repair Circuit: VR-H2005-8S
- * Voltage Set Point:14.4V

Replaces

DENSO :

126000-0570

HONDA :

31150-PE7-661 31150-PE7-6620

Unit no.

DENSO

100211-1351 100211-1370 100211-7330

HONDA

31100-P3003 31100-PE7-660 31100-PE7-661 31100-PG7-013

VR-H2005-81

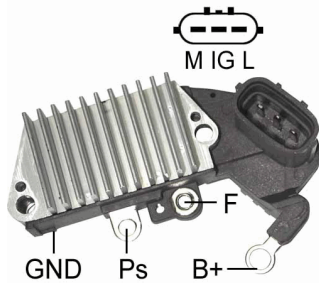

- * M-IG-L Terminals
- * 63.5mm Mounting Length
- * L Terminal Does Not Drive Choke
- * Soft Start
- * Load Response Control
- * W/Capacitor Inside
- * Voltage Set Point:14.2V

Unit no.

DENSO

102211-167 102211-168

TOYOTA

27060-23020 27060-23030

VR-H2005-82

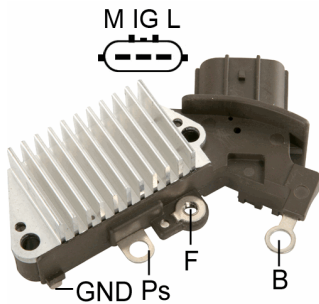

- * M-IG-L Terminals
- * 63.5mm Mounting Length
- * Load Response Control
- * Soft Start
- * W/Capacitor Inside
- * Voltage Set Point:14.4V

Replaces

DENSO :

126000-2871

Unit no.

DENSO

102211-1471

VR-H2005-83

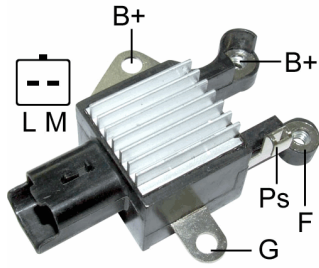

- * M-L Terminals
- * Soft Start
- * 2.5 sec. LRC
- * Short Circuit Protected
- * W/Capacitor Inside
- * Voltage Set Point: 14.4V

Replaces

DENSO :
N810F01288 ST17001

Unit no.

DENSO
104210-3170 104210-3240

VR-H2005-85

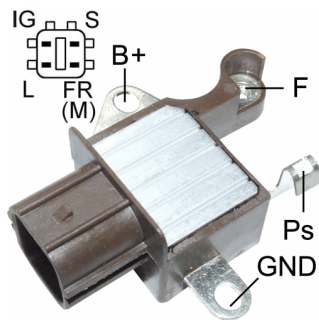

- * IG-S-L-FR Terminals
- * Soft Start
- * 6.0 sec. LRC
- * Short Circuit Protection
- * Inactive Lamp
- * W/Capacitor Inside
- * Voltage Set Point:14.2V

Replaces

DENSO :
126600-3010 126600-3040 126600-3390 126600-3360

HONDA :
31150-RAA-A010M 31150-RAA-A030M

TOYOTA :
27700-20090 27700-20100

Unit no.

DENSO
104210-345 104210-362 104210-365 104210-375 104210-403 104210-404
104210-418 104210-2360 104210-2350 104210-2341 104210-2650 104210-1461
104210-2100
TOYOTA
27060-0T130 27060-0V010 27060-0V060 27060-0A110 27060-0A120 27060-0A130
27060-0A140 27060-0H100 27060-0H110 27060-20270 27060-20280 27060-28260
27060-28290 27060-0V030 27060-OP240

Used On

LEXUS

ES330 3.3L 2004-2006

TOYOTA

Camry 2.4L 2004-2006

Highlander 3.3L 2004-2007

Solara 2.4L 2004-2006

VR-H2005-88

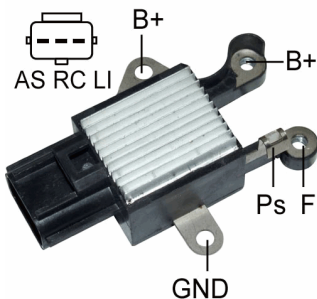

- *A-Circuit
- *AS-RC-LI Terminals
- *Short Circuit Protection
- *Voltage Set Point:14.2V
- *Regulated Voltage Control(RVC)
- *Requires VR-RVC01 test adaptor for testing

Replaces

DENSO :

PCM-01 126600-3460

Unit no.

DENSO

104210-3512	104210-4091	104210-4700	104210-5300	3M5T-10300-YD	104210-3511
104210-3521	104210-3522	104210-3523			

Used On

FORD

Focus	2.0 TDCi	2003-
Foucs	1.6 TDCi	2003-

VR-H2005-89

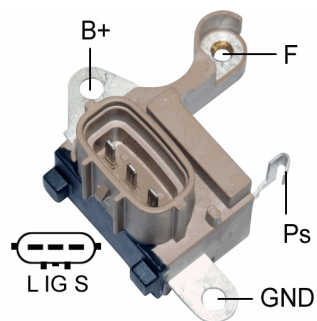

- * S-IG-L Terminals
- * Soft Start
- * Short Circuit Protection
- * W/Capacitor Inside
- * Voltage Set Point:14.2V

Replaces

DENSO :

126600-0011

Unit no.

DENSO

104210-3030	104210-3031	104210-3920	104210-3921
-------------	-------------	-------------	-------------

Used On

Lexus

LS430	2001-2008
SC430	2001-2008

VR-H2005-90

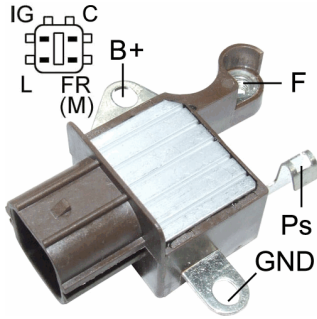

- * IG-C-L-FR(M) Terminals
- * B-Circuit
- * Soft Start
- * 8.5 sec. LRC
- * Short Circuit Protection
- * W/Capacitor Inside
- * Voltage Set Point:14.4V

Replaces

DENSO :

122600-0140 126600-3200 126600-3350

Unit no.

DENSO

104210-3290 104210-3291 104210-3292 104210-3293 104210-3970

HONDA

31100-RAA-A01 31100-RAA-A03 31100-RAA-A04 31100-RAA-A05 31100-RTA-003 31100-RTA-013

Used On

HONDA

Accord	2.4L	2003-2005
Element	2.4L	2003-2006

VR-H2005-91

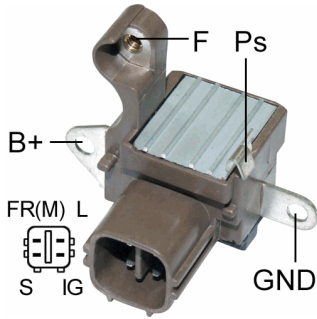

- * IG-S-L-FR(M) Terminals
- * B-Circuit
- * Inactive Lamp
- * Soft Start
- * Short Circuit Protection
- * W/Capacitor Inside
- * Voltage Set Point:14.2V

Replaces

DENSO :

126600-0150

Unit no.

DENSO

104210-3380 104210-3381 104210-3390 104210-3440 104210-3460 104210-4460

TOYOTA

27060-30080

Used On

LEXUS

LX470	2003-2005
-------	-----------

TOYOTA

Land Cruiser	2003-2007
Sequoia	2003-2006

VR-H2005-92

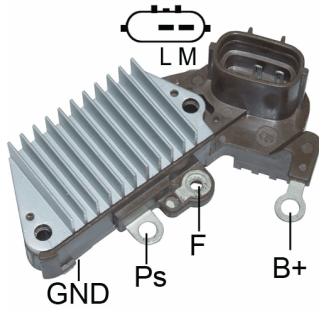

- * L-M Terminals
- * Soft Start
- * 2.5 sec LRC
- * Short Circuit Protection
- * W/Capacitor Inside
- * Voltage Set Point:14.4V

Unit no.

HYUNDAI	
37300-3C120	37300-3C170
POONG SUNG	
02131-9330	02131-9153

VR-H2005-93

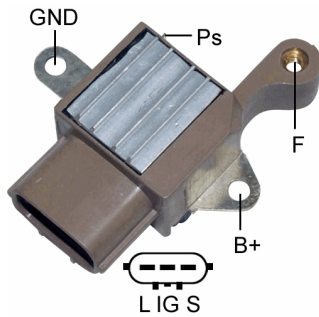

- * S-IG-L Terminals
- * B-Circuit
- * Inactive Lamp
- * Soft Start
- * 6.0 sec. LRC
- * Short Circuit Protection
- * W/Capacitor Inside
- * Voltage Set Point:14.2V

Replaces

DENSO :	
126600-0022	126600-0023

Unit no.

DENSO	
102410-304	104210-312
TOYOTA	
27060-20170	27060-20190

Used On

LEXUS		
RX300	3.0L	2001-2003
TOYOTA		
Highlander	3.0L	2001-2003

VR-H2005-94

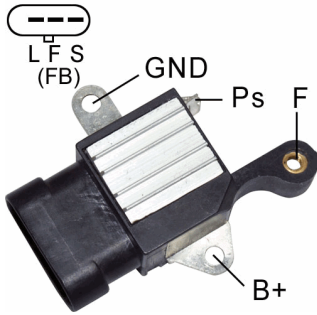

- * S-F-L Terminals
- * B-Circuit
- * Soft Start
- * 8.5 sec. LRC
- * W/Capacitor Inside
- * Short Circuit Protection
- * Voltage Set Point:14.6V

Replaces

DENSO :

126600-0030 126600-0031

Unit no.

DENSO

10421-0306 10421-0307 10421-0330

GM

25697765 25697766 25759348 25759776

Used On

GM

Buick LeSabre	3.8L	2004-
Cadillac Deville	FWD 4.6L	2001-2005
Cadillac Seville	4.6L	2001-2004
Pontiac Bonneville	3.8L	2004-
Pontiac Bonneville	4.6L	2004-2005

VR-H2005-95

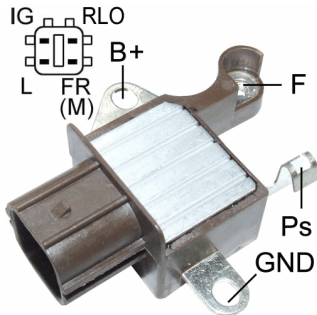

- * RLO-IG-L-M Terminals
- * W/Capacitor Inside
- * Voltage Set Point: 14.2V
- * Regulated Voltage Control(RVC)
- * Requires VR-RVC01 test adaptor for testing

Replaces

DENSO :

126600-3020 126600-3220 126600-3320

Unit no.

DENSO

104210-209 104210-474 104210-475 104210-479

TOYOTA

27060-28300 27060-31090 27060-31100 27060-31101

Used On

TOYOTA

RAV 4	2004-2008
-------	-----------

VR-H2005-96

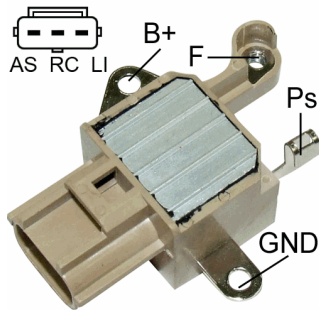

- * B-Circuit
- * AS-RC-LI Terminals
- * W/Capacitor Inside
- * Regulated Voltage Control(RVC)
- * Used on 2nd Generation Ford Focus C-Max
- * Requires VR-RVC01 test adaptor for testing

Replaces

DENSO :

126600-3430 126600-3640

Unit no.

DENSO

104210-3513 104210-3523 104210-6101 104210-6340

FORD

7C3T-10300EE BL3T-10300BC 3M5T-10300PB 3M5T-10300PC 3M5T-10300PD

Used On

FORD

Fiesta V(JH_,JD_) 1.6 TDCi 66kW 2004-
Focus C-MAX 1.6 TDCi 80kW 2003-2007
Focus II(DA_) 1.6 TDCi 80kW 2004-
Focus II(DA_) 2.0 TDCi 100kW 2004-
Fusion(JU_) 1.6 TDCi 66kW 2004-

VR-H2005-99

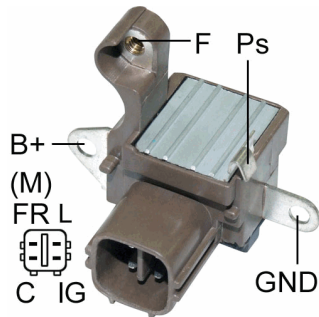

- * Inactive Lamp
- * IG-C-L-M(FR) Terminals
- * Soft Start
- * 2.5 sec. LRC
- * Short Circuit Protection
- * W/Capacitor Inside
- * Voltage Set Point:14.4V

Replaces

DENSO :

126000-0041 126000-0042 126600-0040 126600-3070 126600-3150

Unit no.

DENSO

104210-309 104210-3091 104210-3092 104210-3500

Used On

HONDA

Accord 3.0L 2007-
Acura MDX 3.5L 2001-2002
Odyssey 3.5L 2002-2004
Pilot 3.5L 2003-2004

VR-H2005-9A

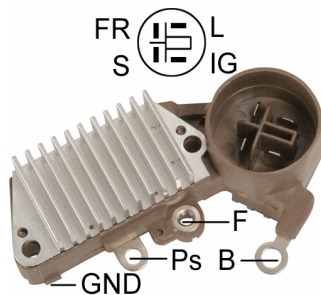

- * S-FR-IG-L Terminals
- * 63.5mm Mounting Length
- * L Terminal Drives Choke
- * Soft Start
- * W/Capacitor Inside
- * Repair Circuit: VR-H2005-9AS
- * Voltage Set Point:14.4V

Replaces

DENSO :

126000-0540 126000-1170

HONDA :

31150-PD6-004 31150-PD6-014 31150-PD6-024 31150-PH3-013

Unit no.

DENSO

100211-2010 100211-2130 100211-2140 100211-2550 100211-3310 100211-7070
 100211-7240 100211-7500

HONDA

31000-PH7-013 31100-PD6-014 31100-PH3-0243 31100-PH3-J01 31100-PH7-004 31100-PH7-013
 31100-PH7-024 31100-PHJ-004 31100-PJ0-663 31100-PJ0-6633 31100-PK2-0031 31100-PK2-004
 31100-PK2-0146 31100-PK2-0241 31100-PK3-A011 31100-PK3-A020M 31100-PP8-004

VR-F341



- *Regitar No.:GR341
- *Electronic type
- *For use on Ford car & Trucks
- *Voltage Set Point:14.5V

Replaces

FORD :				
C3TZ-10316A	C3TZ-10316AA	C3TZ-10316B	D4TZ-10316A	
MOTORCRAFT :				
GR341A	GR341B			

VR-F540A



- *Regitar No.:GR540A
- *Short Circuit Protected
- *For use on Ford car & Trucks
- *Voltage Set Point:14.5V

Replaces

FORD :				
D9PZ-10316A	E2PZ-10316A	E4AZ-10316B		
MOTORCRAFT :				
GR504	GR533	GR534	GR540	GR540A

VR-F540DH

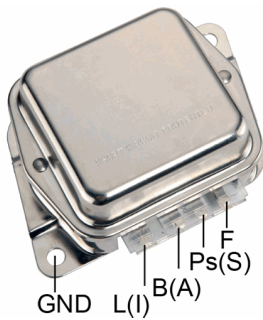

- *Regitar No.:GR540DH
- *Compatible With 7 Amp Rotors
- *Digital Dash Compatible
- *Short Circuit Protected
- *For use on Ford, Mercurys & Lincolns
- *Voltage Set Point:14.5V

Replaces

FORD :
E6DF-10316AA

VR-F7078

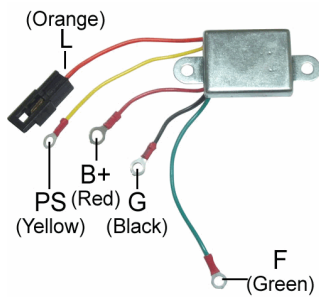

- *Nominal Adjustable
- *PS Open Lamp On
- *Voltage Set Point:14.2V
- *For Ford 1G Series 45-65A ER/EF Alternators

VR-F784H

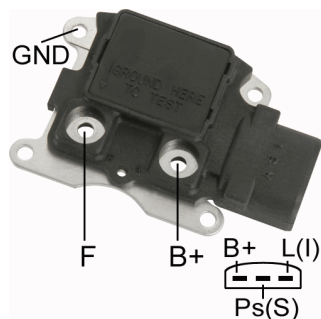

*Regitar No.:GR784
 *For Use on: Ford 2G, 3G Alternators
 *Voltage Set Point:14.45V

Replaces

FORD :

E43F-10316AA	E43Z-10316A	E43Z-10316B	E63F-10316AA	E63F-10316AB	E6TZ-10316A
E43F-10316A	E6YZ-10316A	E73F-10316AB	E73F-10316AC	E73Z-10316A	GR748B
GR784	GR784A	GR784B			

VALEO :

VR-231

Unit no.

FORD

D53F-10300AA	D53F-10300BA	D53F-10300DA	D53F-10300EA	D53F-10300FA	D53F-10300GA
D53F-10300HA	D53F-10346BA	D53F-10346DA	E1AF-10300DA	E43F-10300EA	E43F-10300PA
E43F-10300RA	E43F-10346B	E43F-10346BA	E43Z-10346D	E53Z-10346A	E57F-10300AA
E57F-10300BA	E59F-10300DA	E5TZ-10346A	E63F-10300AB	E63F-10300BB	E63F-10300CB
E63F-10300DA	E63Z-10346A	E63Z-10346B	E67F-10300CA	E67F-10300DA	E67F-10300EA
E67F-10300FA	E67F-10346AA	E67F-10346CA	E67Z-10346A	E69F-10300AA	E69F-10300BA
E69F-10346AA	E69F-10346BA	E6AF-10300AA	E6AF-10300BA	E6DF-10300BA	E6DF-10300DA
E6DF-10300EA	E6DF-10300EB	E6DF-10300GA	E6DF-10346A	E6DF-10346CA	E6DZ-10346B
E6DZ-10346C	E6EF-10300EA	E6EF-10300FA	E6EF-10300GA	E6EF-10300HA	E6EF-10300JA
E6EF-10346AA	E6EF-10346CA	E6FZ-10346C	E6RZ-10346C	E6SF-10300BA	E6TF-10300AA
E6TF-10300BA	E6TF-10300CA	E6TF-10300DA	E6TZ-10346A	E6TZ-10346B	E6UF-10300AA
E6ZF-10300CA	E6ZZ-10346B	E73F-10300BA	E73F-10300CA	E79F-10300BA	E7AF-10300CA
E7DF-10300GA	E7EF-10300CB	E7EF-10300DB	E7EF-10300EB	E7EF-10300FB	E7EF-10300GA
E7PF-10346AA	E7PF-10346AZ	E7PF-10346BA	E7PF-10346CA	E7PF-10346DA	E7PF-10346FA
E7PF-10346GA	E7PF-10346KA	E7PF-10346LA	E7PF-10346MA	E7PF-10346NA	E7PF-10346UA
E7PF-10346XA	E7PY-10346A	E7PZ-10346C	E7PZ-10346D	E7PZ-10346E	E7PZ-10346F
E7PZ-10346G	E7PZ-10346H	E7PZ-10346J	E7PZ-10346K	E7PZ-10346L	E7PZ-10346M
E7PZ-10346N	E7SF-10300FA	E7SF-10300HA	E7SF-10300KA	E7SF-10300LA	E7SF-10300MA
E7TF-10300BA	E7TF-10300LA	E7TF-10300MA	E7TF-10300SA	E7ZF-10300BA	E7ZF-10300DA
E7ZF-10300EA	E7ZF-10300FA	E87F-10300AA	E87F-10300BA	E87F-10300CA	E8EF-10300AB
E8HT-10300HA	E8PF-10346AA	E8PF-10346DA	E8PZ-10346A	E8PZ-10346C	E8SF-10300BA
E8TF-10300BA	E8TF-10300CA	E97F-10300AB	E97F-10300BA	E99F-10300	E99F-10300AB
E9DF-10300BB	E9EF-10300AA	E9EF-10300BA	E9PF-10346AB	E9PF-10346BA	E9PF-10346CB
E9PZ-10346A	E9PZ-10346B	E9PZ-10346C	E9PZ-10346D	E9SF-10300BA	E9UF-10300DA
F0EU-10300AA	F0PF-10346AA	F0PZ-10300F	F0PZ-10346E	F8PF-10346BA	F8PF-10346CB

VR-F784M

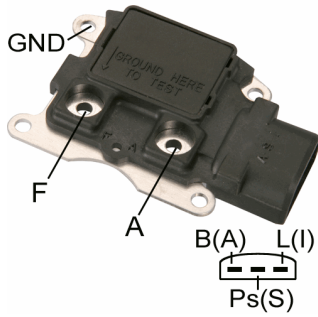

- *Regitar No.:GR784M
- *Short Circuit Protected
- *For Use on: Ford 2G, 3G Alternators
- *Voltage Set Point: 14.7V

Replaces

FORD :

E43F-10316AA	E43Z-10316A	E43Z-10316B	E63F-10316AA	E63F-10316AB	E6TZ-10316A
--------------	-------------	-------------	--------------	--------------	-------------

Unit no.

FORD

D53F-10300AA	D53F-10300BA	D53F-10300EA	D53F-10300FA	D53F-10300GA	D53F-10300HA
D53F-10346BA	D53F-10346DA	D53F-41300DA	E43F-10300PA	E43F-10300RA	E43F-10346B
E43F-10346BA	E43Z-10346D	E53Z-10346A	E57F-10300AA	E57F-10300BA	E59F-10300DA
E5TZ-10346A	E63F-10300AB	E63F-10300BB	E63F-10300CB	E63F-10300DA	E63F-10300EA
E63Z-10346A	E63Z-10346B	E65F-Z10346C	E67F-10300CA	E67F-10300DA	E67F-10300FA
E67F-10346AA	E67F-10346CA	E67Z-10346A	E69F-10300AA	E69F-10300BA	E69F-10346AA
E69F-10346BA	E6AF-10300AA	E6AF-10300BA	E6DF-10300BA	E6DF-10300DA	E6DF-10300EA
E6DF-10300EB	E6DF-10300GA	E6DF-10346A	E6DF-10346CA	E6DZ-10346B	E6DZ-10346C
E6EF-10300EA	E6EF-10300FA	E6EF-10300GA	E6EF-10300HA	E6EF-10300JA	E6EF-10346AA
E6EF-10346CA	E6FZ-10346A	E6SF-10300BA	E6TF-10300AA	E6TF-10300BA	E6TF-10300CA
E6TF-10300DA	E6TZ-10346A	E6TZ-10346B	E6TZ-10346C	E6UF-10300AA	E6ZF-10300CA
E6ZZ-10346B	E73F-10300BA	E73F-10300CA	E79F-10300BA	E7AF-10300DA	E7DF-10300GA
E7EF-10300CB	E7EF-10300DB	E7EF-10300EB	E7EF-10300FB	E7EF-10300GA	E7PF-10346AA
E7PF-10346BA	E7PF-10346CA	E7PF-10346DA	E7PF-10346FA	E7PF-10346GA	E7PF-10346KA
E7PF-10346LA	E7PF-10346MA	E7PF-10346NA	E7PF-10346UA	E7PF-10346XA	E7PZ-10346C
E7PZ-10346D	E7PZ-10346E	E7PZ-10346F	E7PZ-10346G	E7PZ-10346H	E7PZ-10346J
E7PZ-10346K	E7PZ-10346L	E7PZ-10346M	E7PZ-10346N	E7RY-10346A	E7SF-10300GA
E7SF-10300HA	E7SF-10300KA	E7SF-10300LA	E7SF-10300MA	E7TF-10300BA	E7TF-10300LA
E7TF-10300MA	E7TF-10300SA	E7ZF-10300BA	E7ZF-10300DA	E7ZF-10300EA	E7ZF-10300FA
E87F-10300AA	E87F-10300BA	E87F-10300CA	E8EF-10300AB	E8HT-10300HA	E8PF-10346AA
E8PF-10346CB	E8PF-10346DA	E8PZ-10346C	E8SF-10300BA	E8TF-10300BA	E8TF-10300CA
E97F-10300AB	E97F-10300BA	E991-0300	E99F-10300AB	E9DF-10300BB	E9EF-10300AA
E9EF-10300BA	E9PF-10346AB	E9PF-10346BA	E9PF-10346CB	E9PZ-10346A	E9PZ-10346B
E9PZ-10346C	E9PZ-10346D	E9SF-10300BA	E9UF-10300DA	F0EU-10300AA	F0PF-10346AA
F0PZ-10300F	F0PZ-10346E				

VR-F786BH

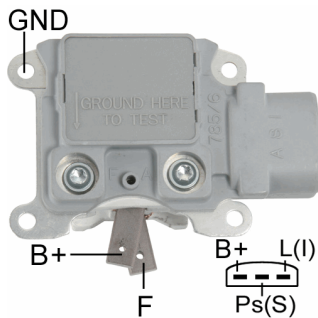

- *With Brush Holder
- *W/O LRC
- *Voltage Set Point:14.45V

Replaces

FORD :

E0DZ-10316A	E9DF-10316AA
-------------	--------------

MOTORCRAFT :

GR801

VR-F786H

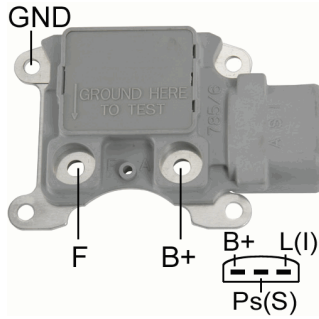

*Regitar No.:GR786
 *For Use on: Ford 2G, 3G Alternators
 *Voltage Set Point:14.45V

Replaces

FORD :
 E0DZ-10316A E9DF-10316AA
MOTORCRAFT :
 GR801

Unit no.

FORD					
F02Z-10346C	F07F-10300AA	F07U-10300AC	F09F-10300AA	F0CF-10300AA	F0CU-10300AA
F0CU-10300AB	F0CU-10300AC	F0CZ-10346A	F0CZ-10346C	F0DF-10300AA	F0DF-10300BA
F0DU-10300BB	F0DU-10300BC	F0DZ-10346A	F0DZ-10346B	F0DZ-10346C	F0DZ-10346D
F0PU-10346CA	F0PU-10346DA	F0PU-10346DD	F0PU-10346MC	F0PU-10346NC	F0PZ-10346A
F0VF-10300AA	F0VU-10300AA	F0VY-10346A	F0VY-10346B	F13U-10300AC	F13U-10300AD
F13Z-10346A	F1DU-10300AD	F1DU-10300AE	F1DZ-10346A	F1PU-10346AC	F1PU-10346BE
F1PU-1034BE	F1SU-10300AC	F1SU-10300AD	F1SZ-10346A	F1TZ-10346B	F1VU-10300BB
F1VU-10300BC	F1VY-10346A	F1VY-10346B	F2UZ-10346B		

VR-F786HB

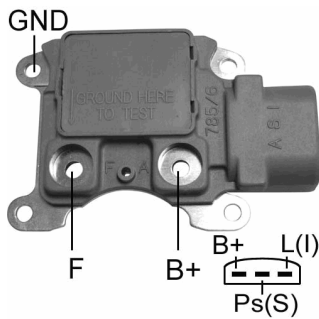

*Regitar No.:GR786HB
 *Short Circuit Protected
 *For Use on: Ford 2G, 3G 220A Alternators
 *Voltage Set Point: 14.7V

VR-F786HC

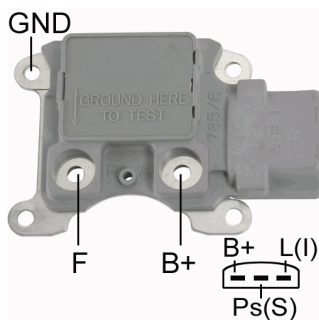

The VP4L2U-10316-AA Looks Like the Older F0DU-10316-AA, Except the Switching Speed of This Regulator is Faster. This Regulator Can Be Used in Place of the Older F0DU-10316-AA (8050-510), BUT Do NOT USE the 8050-510 to Replace the 8050-515.

Replaces

FORD :
 VP4L2U-10316AA
MOTORCRAFT :
 GR801

VR-F786M

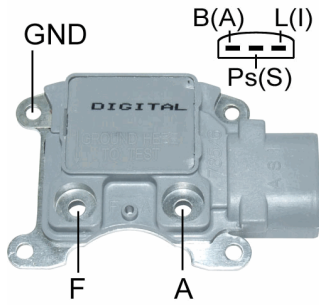

- *Regitar No.:GR786M
- *Short Circuit Protected
- *For Use on: Ford 2G, 3G Alternators
- *Voltage Set Point: 14.7V

Replaces

FORD :

E9DF-10316AA F0DZ-10316A

MOTORCRAFT :

GR801

Unit no.

FORD

F02Z-10346C	F07F-10300AA	F07U-10300AC	F09F-10300AA	F0CF-10300AA	F0CU-10300AA
F0CU-10300AB	F0CU-10300AC	F0CZ-10346A	F0CZ-10346C	F0DF-10300AA	F0DF-10300BA
F0DU-10300BB	F0DU-10300BC	F0DZ-10346A	F0DZ-10346B	F0DZ-10346C	F0DZ-10346D
F0PU-10346CA	F0PU-10346DA	F0PU-10346DD	F0PU-10346MC	F0PU-10346NC	F0PZ-10346A
F0VF-10300AA	F0VU-10300AA	F0VY-10346A	F0VY-10346B	F13U-10300AC	F13U-10300AD
F13Z-10346A	F1DU-10300AD	F1DU-10300AE	F1DZ-10346A	F1PI-1034BE	F1PU-10346AC
F1PU-10346BE	F1SU-10300AC	F1SU-10300AD	F1SZ-10346A	F1TZ-10346B	F1VU-10300BB
F1VU-10300BC	F1VY-10346A	F1VY-10346B	F2UZ-10346B		

VR-F786SE

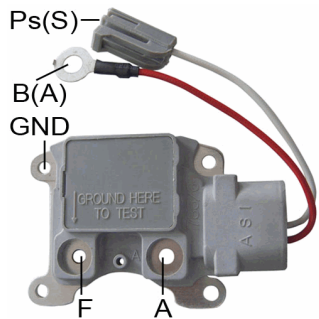

- *Self Exciting
- *Voltage Set Point: 14.6V

Replaces

FORD :

E0DZ-10316A E9DF-10316AA

VR-F811

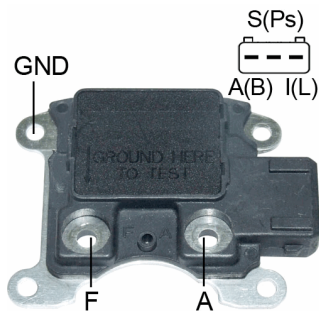

- *Regitar No.:GR811
- *For Use on: Ford 3G Alternators
- *Voltage Set Point:14.7V

Replaces

FORD :

F3AZ-10316A F3AZ-10346A F3RU-10316AA GR811 F3AU-10316AA F3AZ-10316A

MOTORCRAFT :

GR811

Unit no.

FORD

F3AU-10300CA

VR-F811BH

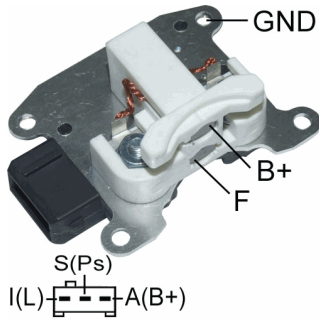

*With Brush Holder
 *For Use on: Ford 3G Alternators
 *Voltage Set Point:14.7V

Replaces

FORD :
 F3AZ-10316A F3AZ-10346A F3RU-10316AA

Unit no.

FORD
 F3AU-10300CA

VR-F814

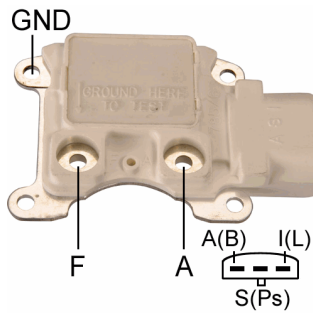

*Regitar No.:GR814
 *Soft Start
 *10 Sec. LRC
 *For Use on: Ford 3G Alternators
 *Voltage Set Point:14.7V

Replaces

FORD :
 F4ZZ-10316A
MOTORCRAFT :
 GR814

Unit no.

FORD
 F4DU-10300CA F4DU-10300DA FD3U-10300CA GL310

VR-F815

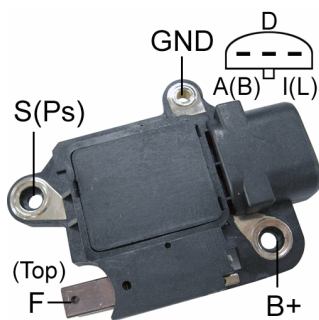

*Regitar No.:GR815
 *Soft Start
 *10 Sec. LRC
 *For Use on: Ford 4G Alternators
 *Voltage Set Point:14.7V

Replaces

FORD :
 F50U-100359AA F50U-10316A F50U-10C359AB

MOTORCRAFT :
 GR815

Unit no.

FORD
 F5DU-10300DB F50U-10300FA F6DU-10300BB F6DU-10300DB

VR-F817

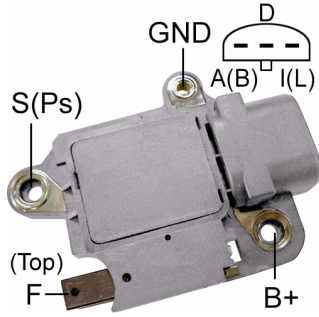

- *Regitar No.: GR817
- *For Use on: Ford 4G Alternators
- *With Short Circuit Protected
- *Voltage Set Point:14.7V

Replaces

FORD :
 F6DU-10C359AA F6DY-10316A GR817

Unit no.

FORD
 F6LU-10300CA F6ZU-10300BC F77U-10300AB

VR-F818

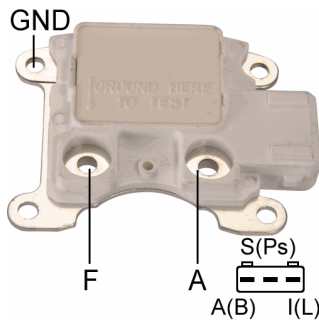

- *Regitar No.:GR818
- *Soft Start
- *6 sec. LRC
- *For Use on: 3G Alternators
- *Voltage Set Point:14.5V

Replaces

FORD :
 F4RU-10316AA F5RU-10316A F5RU-10316BA F5RZ-10316A

MOTORCRAFT :
 GR818 GR819

Unit no.

FORD
 94BB-10300AE F4PU-10300AA F5RU-10300BA F6AZ-103004

VR-F821

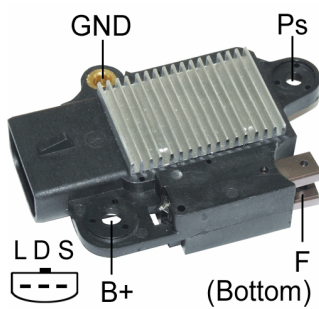

- *Soft Start
- *6 Sec. LRC
- *Short Circuit Protected
- *Voltage Set Point:14.4V
- *Regitar No.: GR821

Replaces

FORD :
 VP4L2U-10C359AA

Unit no.

FORD
 6C2T-10300EB 6C2Z-10346EA

VR-F822

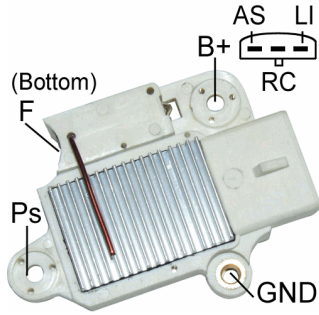

- *Regitar No.:GR822
- *Regulated Voltage Control(RVC)
- *Voltage Set Point:14.0V
- *Requires VR-RVC01 test adaptor for testing

Replaces

FORD :
VP6L8U-10C359AA

VR-F900

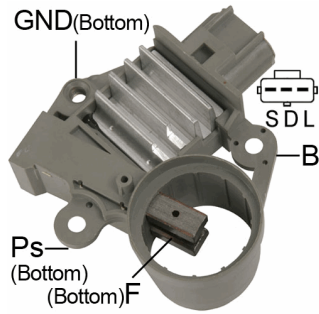

- *Regitar No.:GR900
- *L Terminal Does not Drive Choke
- *Gray Cover
- *Voltage Set Point:14.5V

Replaces

FORD :
F8WU-10C359AB

Unit no.

FORD

F81U-10300BC	F81U-10300CC	F81U-10300DB	F81U-10300DC	F81U-10300EB	F81U-10300GA
F81Z-10346BA	F81Z-10346CA	F81Z-10346DA	F81Z-10346EA	F81Z-10346GA	XR3U-10300AA
XR3Z-10346AA					

VR-F901

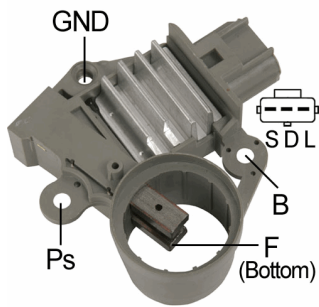

- *Regitar No.: GR901
- *Soft Start
- *Short Circuit Protection
- *w/green cover
- *Voltage Set Point:14.2V

Replaces

FORD :
VP3C3U-10C359AA

Unit no.

FORD

1R3U-10300AA	1R3U-10300AD	2C3U-10300BB	4C3T-10300AA	4C3T-10300BA
--------------	--------------	--------------	--------------	--------------

VR-F910

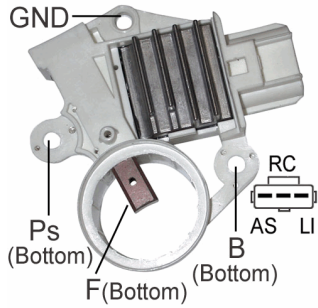

- *Regitar No.:GR910M
- *A-Circuit
- *w/gray cover
- *Voltage Set Point:14.3V
- *Regulated Voltage Control(RVC)
- *Requires VR-RVC01 test adaptor for testing

Replaces

FORD :

VP4L3U-10C359AA VPF1U-10C359AA XW4U-10C359AB

Unit no.

FORD

1L8U-10300AB	1L8U-10300AC	1L8Z-10346AB	1S41-10300BB	3W1U-10300BB	3W1Z-10346BARM
98AB-10300EB	98AB-10300FC	98AZ-10346EA	98AZ-10346FA	GL456	GL462
XF2U-10300AB	XF2U-10300BC	XF2U-10300BD	XF2Z-10346AA	XF2Z-10346AARM	XF2Z-10346BA
XF2Z-10346BARM	XR8U-10300AE	XR8U-10300AF	XR8U-10300CE	XR8Z-10346AA	XR8Z-10346CE
XW4U-10300AA	XW4U-10300BA	XW4U-10300CC	XW4U-10300CD	XW4U-10300CE	XW4Z-10346AA
XW4Z-10346AARM	XW4Z-10346BA	XW4Z-10346BARM	XW4Z-10346CC	XW4Z-10346CCRM	

VR-F911

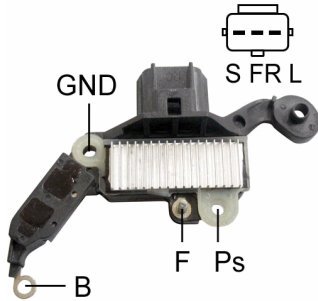

- *S-FR-L Terminals
- *Soft Start
- *8.5 Second LRC
- *Short Circuit Protected
- *Voltage Set Point:14.5V

Unit no.

FORD

2C1T-10300BB 2T1U-10300CA 2T1U-10300CB YC1U-10300DA YC1U-10346DA

LUCAS

LRA2852

VISTEON

20-150-01009

VR-F920

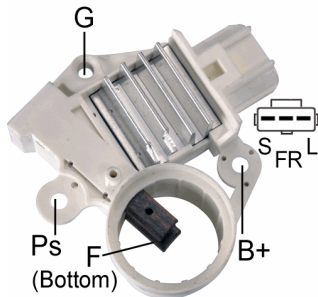

- *Regitar No.:GR920
- *w/white cover
- *Voltage Set Point:14.5V

Replaces

FORD :

XS7U-10C359AC

Unit no.

FORD

98BB-10300CC XS8Z-10346BB

VR-F930

*Regitar No.:GR930
 *w/orange cover
 *Voltage Set Point:14.5V

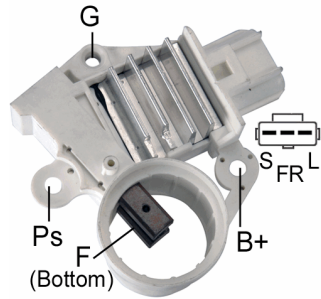

Replaces

FORD :
 XS7U-10C359BA

Unit no.

FORD
 1L8U-10300CD 1L8U-10300DD 1L8Z-10346CB F8RZ-10346CC GL419 GL431
 GL463 XS8Z-10346BBRM XS91-10300BB XS91-10300BC

VR-F931

*Regitar No.: GR931M
 *Voltage Set Point:14.4V

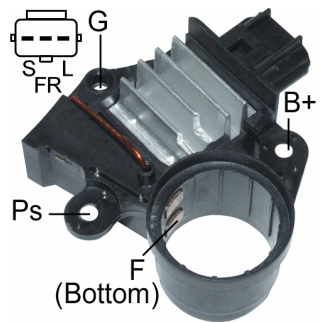

Replaces

FORD :
 VP4L1U-10C359AA

Unit no.

FORD
 3L7Z10346AA 3L7Z10346BA GL550

VR-H2001-1

*24V
*Voltage Set Point:28.3V

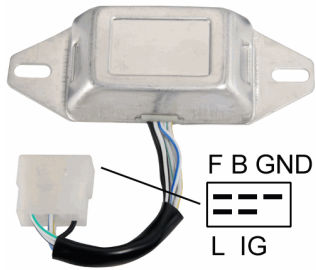

Replaces

HINO :
27700-1480A 5140300610

VR-H2001-2

*24V
*Voltage Set Point:28.3V

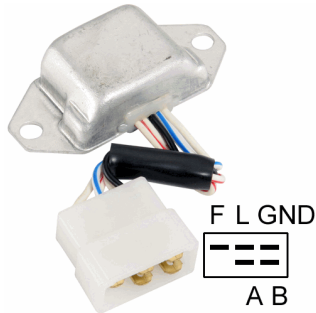

Replaces

HINO :
27700-1210B 5140500411

VR-H2001-3

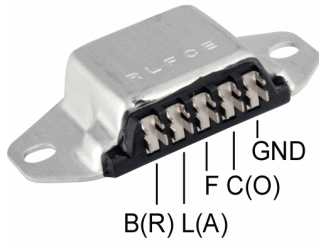

*24V
 *R-L-F-C-E Terminals
 *Voltage Set Point:28.3V

Replaces

HINO :
 27700-1370 27700-1510

KOMATSU :
 21J17

NISSAN :
 23500-99005

SAWAFUJI :
 1219-004-00 1219-005-00 1291-004-00X0

TOSHIBA :
 S5476A

Unit no.

HINO					
27040-1072	27040-1091	27040-1101	27040-1103	27040-1111	27040-1113
27040-1120	27040-1130	27040-1141	27040-1151	27040-1160	27040-1200
27040-1210	27040-1290	27040-1444	27050-1012	27050-1023	27050-1041
27050-1051	27050-1061	27050-1081	27050-1130	27050-1140	27050-1150
27050-1160					
NISSAN					
23100-96074	23100-96075	23100-96077	23100-96078	23100-96174	23100-96176
23100-96177	23100-96263	23100-96265	23100-97068	23100-97069	23100-97070
23100-97071	23100-97072	23100-97114	23100-97115	23100-97117	23100-97164
23100-97165					
SAWAFUJI					
0214-102-0011	0214-102-0021	0214-102-0213	0214-102-0214	0214-102-0410	0214-102-0420
0214-102-0511	0214-102-0611	0214-102-0711	0214-102-0813	0214-102-0911	0214-102-1011
0214-102-1013	0214-102-1111	0214-102-1113	0214-102-1210	0214-102-1220	0214-102-1230
0214-102-1310	0214-102-1320	0214-102-1330	0214-102-1410	0214-102-1420	0214-102-1510
0214-102-1611	0214-102-1711	0214-152-0011	0214-202-0030	0214-202-0110	0214-202-0210
0214-202-0220	0214-202-0230	0214-252-0011	0214-252-0020	0214-302-0010	0214-302-0040
0214-302-0050	0214-302-0110	0214-501-0010	0214-501-0110	0214-801-0110	

VR-H2000-1

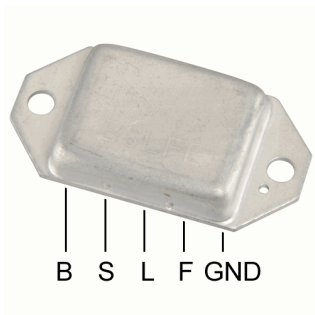

*B-S-L-F-E Terminals
 *VR-H2000-1H(14V): Heavy Duty
 *VR-H2000-1L(Volts Setting: 14.4V)
 *Voltage Set Point:14.7V

Replaces

BOSCH :

0-986-192-026 0-986-192-036

HITACHI :

TR1Z-27 TR1Z-33 TR1Z-47 TR1Z-48 TR1Z-56 TR1Z-65

LUCAS :

21511113

MAGNETI MARELLI :

940038078 940038089

NISSAN :

23215-B9800 23215-F2500 23215-P2500 23215-Q4601 23215-Q4602

SUBARU :

42990-7100 49575-7101 49575-7301

Unit no.

HITACHI

LR135-44	LR135-61	LR135-61B	LR138-01	LR150-125	LR150-125B
LR150-194	LR150-194B	LR150-197	LR150-197B	LR150-30B	LR150-31
LR150-35	LR150-46	LR150-50	LR150-51	LR150-52	LR150-53
LR150-58	LR150-94B	LR150-98	LR150-98B	LR150-99	LR150-99B
LR155-15	LR155-15C	LR155-18	LR155-23	LR155-24	LR160-104
LR160-109	LR160-121	LR160-124	LR160-137	LR160-138	LR160-140
LR160-151	LR160-166	LR160-20	LR160-42	LR160-42B	LR160-46
LR160-47	LR160-57	LR160-61	LR160-62	LR160-74	LR160-75
LR160-78	LR160-78B	LR160-82	LR160-82B	LR160-84	LR160-84B
LR160-93	LR170-14	LR170-18	LR170-21	LR170-22	

NISSAN

23100-04M00	23100-10W01	23100-12G00	23100-20R00	23100-29R00	23100-37M00
23100-80W00	23100-84W00	23100-B9800	23100-B9801	23100-B9802	23100-B9805
23100-D0201	23100-D0800	23100-D1700	23100-D3300	23100-H7700	23100-H7701
23100-H7702	23100-H7703	23100-M5960	23100-M6601	23100-N8500	23100-P2506
23100-P3006	23100-Q4500	23100-V0100	23100-V0101	23100-V0102	23100-V0106
23100-V0107	23100-W2501	23100-W5801	23100-W5802	23100-W5803	23100-W5805
23100-W5806	23100-W5807				

SUBARU

23700-AA000	23700-AA020	42990-7320	42990-7330	42990-7340	42990-7400
42990-7600					

VR-H2000-10

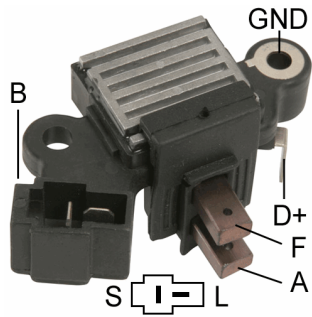

*S-L Terminals
 *Repair Circuit: VR-H2000-10S
 *Voltage Set Point:14.5V

Replaces

HITACHI :
 L165-2315

SUBARU :
 23733-AA000 23773-AA111 49575-7301

Unit no.

HITACHI
 LR165-704
 SUBARU
 23700-AA050

VR-H2000-11

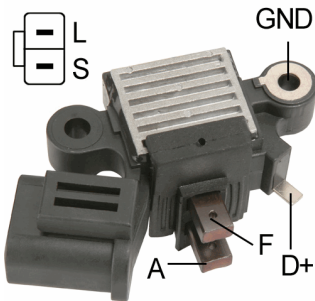

*S-L Terminals
 *Repair Circuit: VR-H2000-19S
 *Voltage Set Point:14.5V

Replaces

HITACHI :
 L170-43151

NISSAN :
 23133-77A00

Unit no.

HITACHI
 LR165-707 LR165-707B LR170-707B LR175-707 LR175-7070
 NISSAN
 23100-77A00

VR-H2000-12

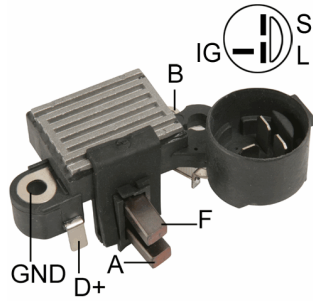

*S-IG-L Terminals
 *Repair Circuit: VR-H2000-9S
 *Voltage Set Point:14.5V

Replaces

ISUZU :

8-94249-860-0

LUCAS :

21511109 UCJ126

Unit no.

HITACHI

LR150-703

ISUZU

8-94413-621-0

VR-H2000-13

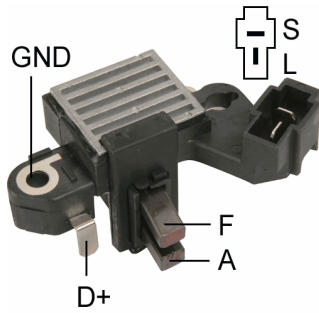

*S-L Terminals
 *Repair Circuit: VR-H2000-13S
 *Voltage Set Point:14.5V

Replaces

HITACHI :

L170-6315

Unit no.

HITACHI

LR160-703 LR170-706

SUBARU

9202-0644

VR-H2000-14

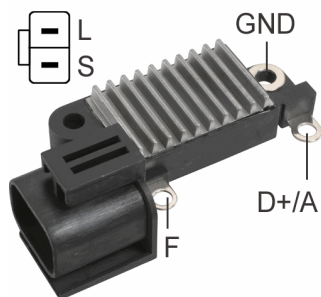

*S-L Terminals
 *Repair Circuit: VR-H2000-14S
 *Voltage Set Point:14.5V

Replaces

HITACHI :
 L170-33152
NISSAN :
 23215-50Y05

Unit no.

HITACHI			
LR165-708B	LR170-738	LR170-738B	LR180-730
NISSAN			
23100-50Y05	23100-50Y07	23100-OE700	23100-OE705

VR-H2000-15

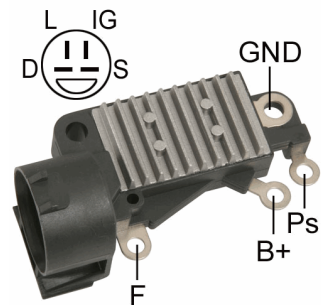

*S-IG-D-L Terminals
 *Repair Circuit: VR-H2000-15S
 *Voltage Set Point:14.5V

Replaces

HITACHI :
 L170-23152
SUBARU :
 23815-AA010

Unit no.

HITACHI	
LR170-732B	LR170-732C
SUBARU	
23700-AA090	

VR-H2000-16

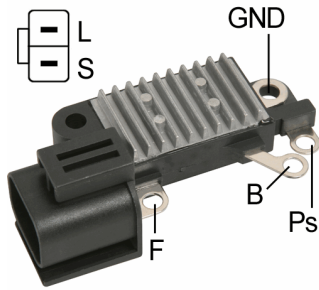

*S-L Terminals
 *Similar to VR-H2000-14, but with Stator Terminal
 *Repair Circuit: VR-H2000-23S
 *Voltage Set Point:14.5V

Replaces

HITACHI :					
L180G-2340	L165G-2315	L180G-6340	L180G-7340		
NISSAN :					
23215-0C001	23215-70T00	23215-85L00			

Unit no.

HITACHI					
LR165-708C	LR170-738C	LR170-744	LR180-7035	LR180-731B	LR190-715B
NISSAN					
23100-0C000	23100-0E700	23100-0E705	23100-85L00	23100-86L00	

VR-H2000-17

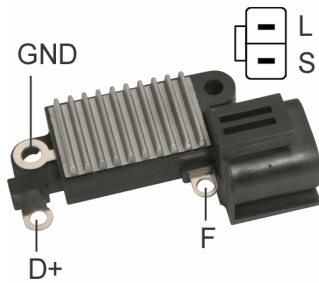

*S-L Terminals
 *Repair Circuit: VR-H2000-17S
 *Voltage Set Point:14.5V

Replaces

HITACHI :					
L180-8315					
NISSAN :					
23215-64J00					

Unit no.

HITACHI					
LR160-723	LR160-723B	LR170-734	LR170-734B	LR170-739	LR180-725
LR180-729	LR180-736B				
NISSAN					
23100-12G02	23100-64J00	23100-80G08	23100-88G00		

VR-H2000-18

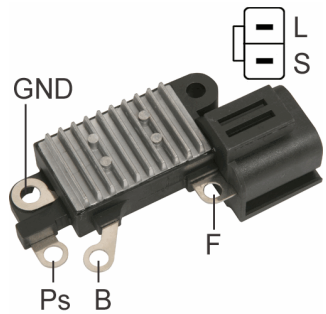

*S-L Terminals
 *Repair Circuit: VR-H2000-18S
 *Voltage Set Point:14.5V

Replaces

HITACHI :		
L180-5340	L180G-9340	
NISSAN :		
23215-64J01	23215-64J00	23215-64J02

Unit no.

HITACHI					
LR160-724	LR170-739B	LR180-725	LR180-725B	LR180-725C	LR180-725E
LR180-734B	LR180-734C	LR180-736B	LR190-719		
NISSAN					
23100-64J01					

VR-H2000-19

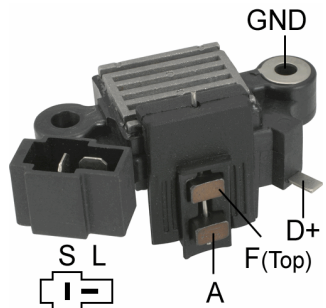

*S-L Terminals
 *Repair Circuit: VR-H2000-19S
 *Voltage Set Point:14.5V

Replaces

HITACHI :	
L165-5315	
SUBARU :	
23733-A0010	23733-AA010

Unit no.

HITACHI	
LR165-704B	LR165-705
SUBARU	
23700-AA150	

VR-H2000-1H

*Heavy Duty
*Voltage Set Point: 14.4V

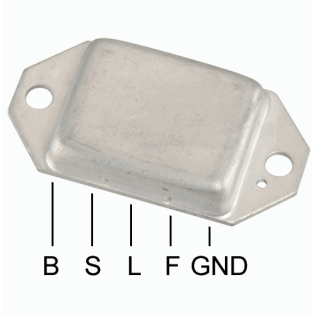

Replaces

BOSCH :

0-986-192-026 0-986-192-036

HITACHI :

TR1Z-27 TR1Z-33 TR1Z-47 TR1Z-48 TR1Z-56 TR1Z-65

NISSAN :

23215-B9800 23215-F2500 23215-P2500 23215-Q4601 23215-Q4602

SUBARU :

42990-7100 49575-7101 49575-7301

Unit no.

HITACHI

LR135-44	LR135-61	LR135-61B	LR138-01	LR150-125	LR150-125B
LR150-194	LR150-194B	LR150-197	LR150-197B	LR150-30B	LR150-31
LR150-35	LR150-46	LR150-50	LR150-51	LR150-52	LR150-53
LR150-58	LR150-94B	LR150-98	LR150-98B	LR150-99	LR150-99B
LR155-15	LR155-15C	LR155-18	LR155-23	LR155-24	LR160-104
LR160-109	LR160-121	LR160-124	LR160-137	LR160-138	LR160-140
LR160-151	LR160-166	LR160-20	LR160-42	LR160-42B	LR160-46
LR160-47	LR160-57	LR160-61	LR160-62	LR160-74	LR160-75
LR160-78	LR160-78B	LR160-82	LR160-82B	LR160-84	LR160-84B
LR160-93	LR170-14	LR170-18	LR170-21	LR170-22	

VR-H2000-1L

*Voltage Setting: 14.4V

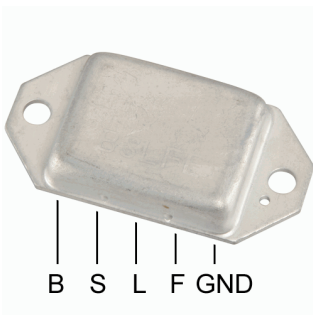

Replaces

BOSCH :

0-986-192-026 0-986-192-036

HITACHI :

TR1Z-27 TR1Z-33 TR1Z-47 TR1Z-48 TR1Z-56 TR1Z-65

NISSAN :

23215-B9800 23215-F2500 23215-P2500 23215-Q4601 23215-Q4602

SUBARU :

42990-7100 49575-7101 49575-7301

VR-H2000-2

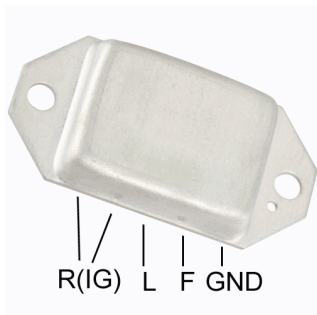

*R-R-L-F-E Terminals
 *Voltage Set Point: 14.5V

Replaces

HITACHI :

TR1Z-44 TR1Z-63

ISEKI :

6581-270-004-0

ISUZU :

5-81270-004-0

SUBARU :

49575-5601

YANMAR :

0124080-77390 XTR1Z-44 XTR1Z-63

Unit no.

HITACHI

LR120-15C	LR120-23	LR135-105	LR135-115	LR135-116	LR135-58B
LR135-86F	LR135-95	LR155-01	LR155-20		

ISEKI

581-200-338-0	581-200-338-1	581-200-349-0	581-200-358-0		
---------------	---------------	---------------	---------------	--	--

ISUZU

5-00181-010-0	5-81200-338-0	5-81200-341-0	5-81200-349-0	5-81200-358-0	
---------------	---------------	---------------	---------------	---------------	--

YANMAR

0121400-77201	128270-77200	129772-77200	129795-77200		
---------------	--------------	--------------	--------------	--	--

VR-H2000-20

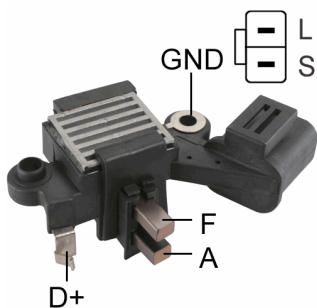

*S-L Terminals
 *Repair Circuit: VR-H2000-19S
 *Voltage Set Point: 14.5V

Replaces

HITACHI :

L190-4315

NISSAN :

23133-F6500

Unit no.

HITACHI

LR170-710B	LR180-705B	LR180-708	LR180-710B	LR180-724	LR190-706
LR190-707	LR190-707B	LR190-714			

NISSAN

23100-16N00	23100-30P00	23100-59S01	23100-F6501		
-------------	-------------	-------------	-------------	--	--

VR-H2000-21

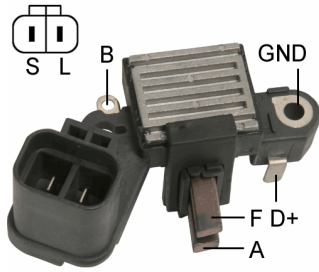

*S-L Terminals
 *Repair Circuit: VR-H2000-10S
 *Voltage Set Point:14.5V

Replaces

HITACHI :
 L170-3315

NISSAN :
 23133-13E00

Unit no.

HITACHI		
LR160-708	LR160-709	LR160-710
NISSAN		
23100-02E00	23100-02E05	

VR-H2000-22

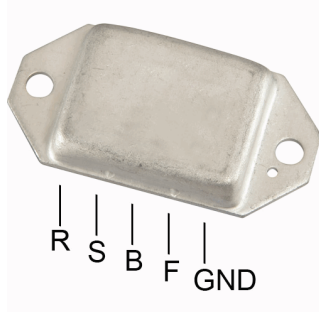

*R-S-B-F-E Terminals
 *Voltage Set Point:14.5V

Replaces

HITACHI :
 TR1Z-46

ISUZU :
 8-94223-967-0

Unit no.

HITACHI
LR140-112
ISUZU
8-94221-451-4

VR-H2000-23

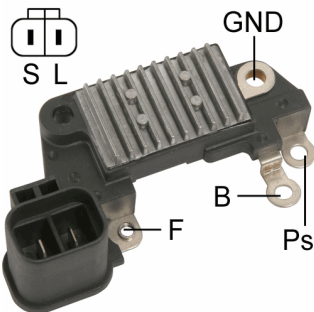

*S-L Terminals
*Voltage Set Point: 14.5V

Replaces

HITACHI :
L195G-2340
NISSAN :
23215-97E01

Unit no.

HITACHI
LR195-701
NISSAN
23100-97E01

VR-H2000-24

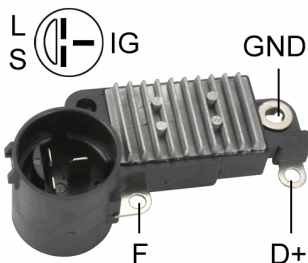

*S-IG-L Terminals
*Repair Circuit:VR-H2000-24S
*Voltage Set Point: 14.5V

Unit no.

HITACHI
LR150-711 LR160-725 LR160-726

VR-H2000-26

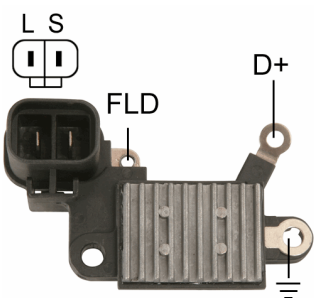

*Repair Circuit:VR-H2000-26S
*S-L Terminals
*Voltage Set Point: 14.5V

Replaces

HITACHI :
L1110-2315

Unit no.

NISSAN
23100-60U00

VR-H2000-27

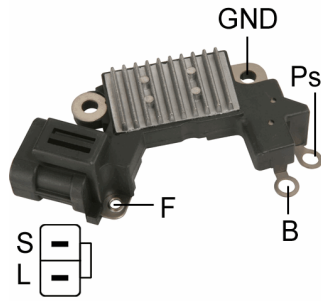

*Repair Circuit:VR-H2000-28S
 *S-L Terminals
 *Voltage Set Point:14.5V

Replaces

HITACHI :
 L185G-4340
SUBARU :
 23815-AA050

Unit no.

HITACHI
 LR190-724
 NISSAN
 23100-70F05

VR-H2000-28

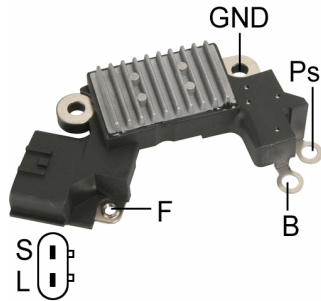

*S-L Terminals
 *Short Circuit Protection
 *Repair Circuit:VR-H2000-28S
 *Voltage Set Point:14.5V

Replaces

HITACHI :
 L1100G-3340 L1100G-9340
NISSAN :
 23215-31U05

Unit no.

HITACHI
 LR1110-705
 NISSAN
 23100-31U01 23100-31U02

VR-H2000-29

*IG-L-S Terminals
*Voltage Set Point:14.5V

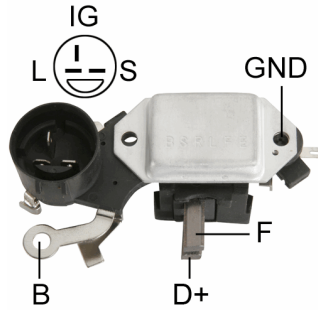

Replaces

GM :

94167410

HITACHI :

L150-33155

ISUZU :

8-94167-410-0

VALEO :

A556536A

Unit no.

HITACHI

LR150-415	LR150-421C	LR150-431	LR150-432	LR150-434B	LR150-438B
LR150-439B	LR155-416	LR155-418B	LR155-419B	LR160-419	LR160-432B
LR160-433B	LR160-433E	LR160-434B	LR160-435E	LR160-443	LR160-444
LR160-444B	LR160-446				

ISUZU

8-94122-488-4	8-94128-056-2	8-94171-674-0	8-94419-519-1	8-94428-885-3	8-94428-886-1
8-94428-887-3	8-94441-959-1	8-94449-054-2	8-94452-134-1	8-94452-739-0	8-94452-739-2
8-94452-740-1	8-94452-740-3	8-94490-540	8-97037-724-1	8-97039-342-0	8-97043-566-0
8-97074-611-0					

VR-H2000-29A-2

*IG-L-S Terminals
*Voltage Set Point:14.5V
*With Capacitor

Replaces

GM :

94167410

HITACHI :

L150-33155

ISUZU :

8-94167-410-0

VALEO :

A556536A

Unit no.

HITACHI

LR150-415	LR150-421C	LR150-431	LR150-432	LR150-434B	LR150-438B
LR150-439B	LR155-416	LR155-418B	LR155-419B	LR160-419	LR160-432B
LR160-433B	LR160-433E	LR160-434B	LR160-435E	LR160-443	LR160-444
LR160-444B	LR160-446				

ISUZU

8-94122-488-4	8-94128-056-2	8-94171-674-0	8-94419-519-1	8-94428-885-3	8-94428-886-1
8-94428-887-3	8-94441-959-1	8-94449-054-2	8-94452-134-1	8-94452-739-0	8-94452-739-2
8-94452-740-1	8-94452-740-3	8-94490-540	8-97037-724-1	8-97039-342-0	8-97043-566-0
8-97074-611-0					

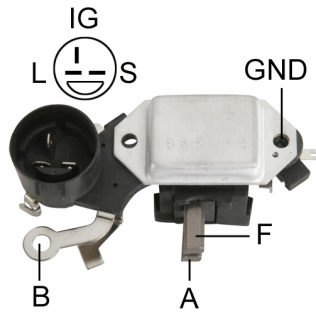
VR-H2000-29B

*24V
 *IG-L-S Terminals
 *Voltage Set Point:28.3V

Replaces

HITACHI :
 TR2Z-49 L225-8315

ISUZU :
 8-94156590-0

NISSAN :
 23215-C6800

Unit no.

HITACHI
 LR270-05
 NISSAN
 23100-17D60

VR-H2000-29BA-2

*24V
 *IG-L-S Terminals
 *Voltage Set Point:28.3V
 *With Capacitor

Replaces

HITACHI :
 TR2Z-49 L225-8315

ISUZU :
 8-94156590-0

NISSAN :
 23215-C6800

Unit no.

HITACHI
 LR270-05
 NISSAN
 23100-17D60

VR-H2000-2B

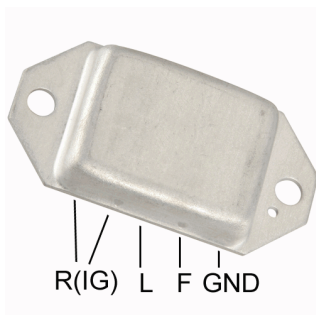

*24V
 *R-R-L-F-E Terminals
 *Voltage Set Point:28.3V

Replaces

HITACHI :
 TR2Z-47

ISUZU :
 5-81251-016-0

NISSAN :
 23500-99008

YANMAR :
 119129-77820

Unit no.

HITACHI

LR215-50	LR220-23	LR220-24	LR225-84T	LR225-85	LR225-86B
LR225-89	LR235-61C	LR235-62	LR235-65	LR235-68	LR235-69
LR235-72B	LR235-76	LR235-80	LR240-19C	LR240-20C	LR240-21
LR240-22E	LR240-25	LR240-26	LR240-29B	LR240-31E	LR240-32

ISUZU

1-81200-393-1	1-81200-401-0	5-81200-330-0	5-81200-335-0	8-94431-560-0	
---------------	---------------	---------------	---------------	---------------	--

NISSAN

23099-Z5518	23099-Z5560	23099-Z5561	23099-Z5562	23100-51H00	23100-95014
23100-96279	23100-96515	23100-96516	23100-97170	23100-97171	23100-K6701
23100-Z5519	23100-Z5563	23100-Z5605	23100-Z5606		

YANMAR

119129-77201	129535-77200				
--------------	--------------	--	--	--	--

VR-H2000-3

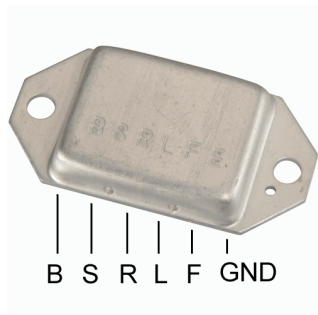

*B-S-R-L-F-E Terminals
 *Voltage Set Point: 14.5V

Replaces

BOSCH :

0-986-192-030

DELCO REMY (LUCAS) :

21511114

HITACHI :

136284 TR1Z-43 TR1Z-53 TR1Z-62 TR1Z-64

ISUZU :

8-94237-720-0 8-94250-964-0 8-94250-968-0

MAZDA :

RF01-24-520 S208-24-520

NISSAN :

23215-54A00 23215-W1700 23215-W1701

Unit no.

HITACHI

LR140-130B	LR140-130P	LR140-131	LR140-131B	LR140-138	LR150-133
LR150-133B	LR150-133C	LR150-133E	LR150-146	LR150-146B	LR150-146C
LR150-155B	LR150-205	LR150-205B	LR150-402	LR150-402C	LR150-403
LR150-436	LR150-55B	LR155-12C	LR155-16	LR155-16B	LR160-107B
LR160-108B	LR160-144	LR160-146B	LR160-147F	LR160-148F	LR160-152F
LR160-164	LR160-401	LR160-401C	LR160-422B	LR160-67H	LR160-92C
LR160-96	LR160-96B	LR160-96C	LR160-96H	LR160-97	LR160-97B
LR160-97C	LR170-401	LR170-404	LR170-410		

ISUZU

8-94155-308-5	8-94155-309-5	8-94234-987-2	8-94234-987-3	8-94238-453-2	8-94246-956-0
8-94246-956-1	8-94246-957-0	8-94246-957-1	8-94401-793-0	8-94401-793-2	8-94407-184-0
8-94408-365-0	8-94408-918-4				

NISSAN

23099-29W00	23099-36W01	23099-36W02	23099-36W04	23099-R8103	23099-R8104
23099-R8109	23099-W1705	23100-10G03	23100-11H00	23100-17A00	23100-17A01
23100-17C00	23100-18A00	23100-18A01	23100-54A01	23100-G3706	23100-M5201
23100-W1806	23100-W1807	23100-W2500	23100-W2501	23100-W2502	23100-W3405
23100-W5800					

VR-H2000-30

*S-L Terminals
 *Voltage Set Point: 14.5V

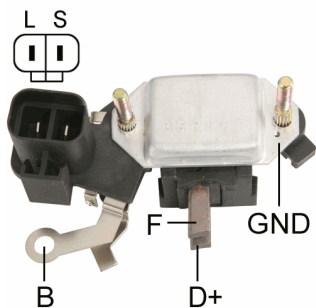

Replaces

HITACHI :

L150-93155 L160-63153

NISSAN :

23528-18G01 23528-V7200

Unit no.

HITACHI

LR140-415B	LR140-419	LR140-419T	LR140-421	LR140-421T	LR140-422T
LR150-425B	LR150-428S	LR150-428T	LR150-430S	LR150-435S	LR150-435T
LR150-443S	LR160-417	LR160-421C	LR160-421F	LR160-422B	LR160-426S
LR160-426T	LR160-427S	LR160-427T	LR160-436S	LR160-437S	LR170-406B
LR170-406E	LR170-406F	LR170-407S	LR170-407T	LR170-408S	LR170-412S
LR170-412T	LR170-413	LR170-414B	LR170-414E	LRT150-430T	

NISSAN

23100-02N20	23100-11T16	23100-43G08	23100-44G02	23100-56C01
-------------	-------------	-------------	-------------	-------------

VR-H2000-31

*S-L Terminals
*Voltage Set Point: 14.7V

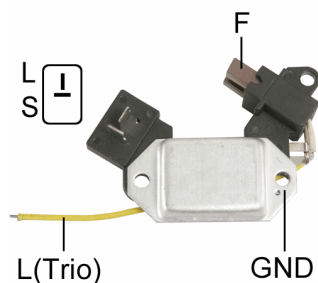

Replaces

BOSCH :

0-986-192-026 0-986-192-036

HITACHI :

TR1Z-27	TR1Z-28	TR1Z-33	TR1Z-47	TR1Z-48	TR1Z-56
TR1Z-65					

LUCAS :

21511113

MAGNETI MARELLI :

940038078 940038089

NISSAN :

23215-B9800	23215-F2500	23215-P2500	23215-Q4601	23215-Q4602
-------------	-------------	-------------	-------------	-------------

SUBARU :

42990-7100	49575-7101	49575-7301
------------	------------	------------

Unit no.

HITACHI

LR135-44	LR135-61	LR135-61B	LR138-01	LR150-125	LR150-125B
LR150-194	LR150-194B	LR150-197	LR150-197B	LR150-30B	LR150-31
LR150-35	LR150-46	LR150-50	LR150-51	LR150-52	LR150-53
LR150-58	LR150-94B	LR150-98	LR150-98B	LR150-99	LR150-99B
LR155-15	LR155-15C	LR155-18	LR155-23	LR155-24	LR160-104
LR160-109	LR160-121	LR160-124	LR160-137	LR160-138	LR160-140
LR160-151	LR160-166	LR160-20	LR160-42	LR160-42B	LR160-46
LR160-47	LR160-57	LR160-61	LR160-62	LR160-74	LR160-75
LR160-78	LR160-78B	LR160-82	LR160-82B	LR160-84	LR160-93
LR170-14	LR170-18	LR170-21			

NISSAN

23100-04M00	23100-10W01	23100-12G00	23100-20R00	23100-29R00	23100-37M00
23100-80W00	23100-84W00	23100-B9800	23100-B9801	23100-B9802	23100-B9805
23100-D0201	23100-D0800	23100-D1700	23100-D3300	23100-H7700	23100-H7701
23100-H7702	23100-H7703	23100-M5960	23100-M6601	23100-N8500	23100-P2506
23100-P3006	23100-Q4500	23100-V0100	23100-V0101	23100-V0102	23100-V0106
23100-V0107	23100-W2501	23100-W5801	23100-W5802	23100-W5803	23100-W5805
23100-W5806	23100-W5807				

SUBARU

23700-AA000	23700-AA020	42990-7320	42990-7330	42990-7340	42990-7400
42990-7600					

VR-H2000-32

*S-L Terminals
*Voltage Set Point:14.7V

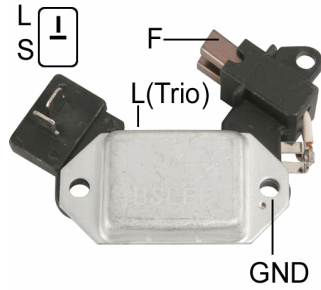

Replaces

BOSCH :

0-986-192-026 0-986-192-036

HITACHI :

TR1Z-27	TR1Z-28	TR1Z-33	TR1Z-47	TR1Z-48	TR1Z-56
TR1Z-65					

LUCAS :

21511113

MAGNETI MARELLI :

940038078 940038089

NISSAN :

23215-B9800	23215-F2500	23215-P2500	23215-Q4601	23215-Q4602
-------------	-------------	-------------	-------------	-------------

SUBARU :

42990-7100	49575-7101	49575-7301
------------	------------	------------

Unit no.

HITACHI

LR135-44	LR135-61	LR135-61B	LR138-01	LR150-125	LR150-125B
LR150-194	LR150-194B	LR150-197	LR150-197B	LR150-30B	LR150-31
LR150-35	LR150-46	LR150-50	LR150-51	LR150-52	LR150-53
LR150-58	LR150-94B	LR150-98	LR150-98B	LR150-99	LR150-99B
LR155-15	LR155-15C	LR155-18	LR155-23	LR155-24	LR160-104
LR160-109	LR160-121	LR160-124	LR160-137	LR160-138	LR160-140
LR160-151	LR160-166	LR160-20	LR160-42	LR160-42B	LR160-46
LR160-47	LR160-57	LR160-61	LR160-62	LR160-74	LR160-75
LR160-78	LR160-78B	LR160-82	LR160-82B	LR160-84	LR160-84B
LR160-93	LR170-14	LR170-18	LR170-21	LR170-22	

NISSAN

23100-04M00	23100-10W01	23100-12G00	23100-20R00	23100-29R00	23100-37M00
23100-80W00	23100-84W00	23100-B9800	23100-B9801	23100-B9802	23100-B9805
23100-D0201	23100-D0800	23100-D1700	23100-D3300	23100-H7700	23100-H7701
23100-H7702	23100-H7703	23100-M5960	23100-M6601	23100-N8500	23100-P2506
23100-P3006	23100-Q4500	23100-V0100	23100-V0101	23100-V0102	23100-V0106
23100-V0107	23100-W2501	23100-W5801	23100-W5802	23100-W5803	23100-W5805
23100-W5806	23100-W5807				

SUBARU

23700-AA000	23700-AA020	42990-7320	42990-7330	42990-7340	42990-7400
42990-7600					

VR-H2000-33

*Voltage Set Point:14.5V

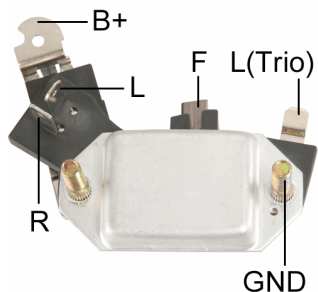

Replaces

HITACHI :
L135-13152

Unit no.

HITACHI
LR135-105 LR135-106 LR135-126

VR-H2000-34

*Voltage Set Point:14.5V

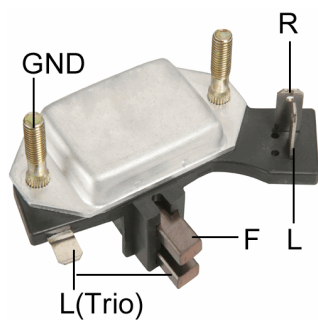

Replaces

HITACHI :
L135-43153

Unit no.

HITACHI
LR120-23 LR135-104 LR135-125 LR135-127 LR135-128 LR135-86F
LR135-91 LR135-95

VR-H2000-35

*Voltage Set Point:14.5V

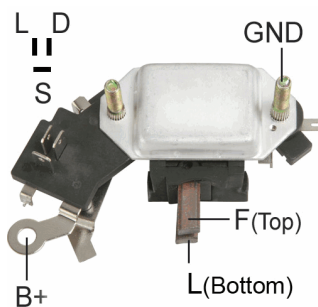

Replaces

HITACHI :
L150-23155

NISSAN :
23528-29W00

Unit no.

HITACHI
LR155-16P LR155-408

VR-H2000-36

*Voltage Set Point:14.5V

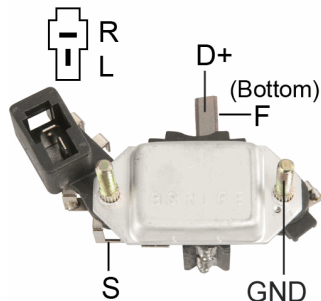

Replaces

HITACHI :
L150-73154

Unit no.

HITACHI
LR140-406 LR140-410F LR140-423F LR150-410F

VR-H2000-37

*Voltage Set Point:14.7V

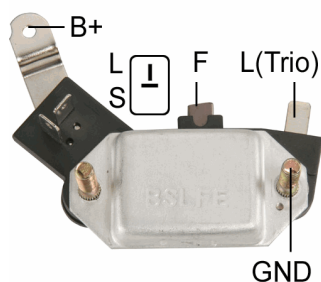

Replaces

BOSCH :
0-986-192-028

HITACHI :
L150-43151 L150-63151

NISSAN :
23133-D0200 23133-Q4601 23133-W1606 23133-W7101

Unit no.

HITACHI
LR150-100 LR150-101B LR150-125B LR150-132B LR150-98E LR150-99B
LR160-105 LR160-109C LR160-130 LR160-77 LR160-79 LR160-85B
LR170-10
NISSAN
23100-01N06 23100-27G00

VR-H2000-38

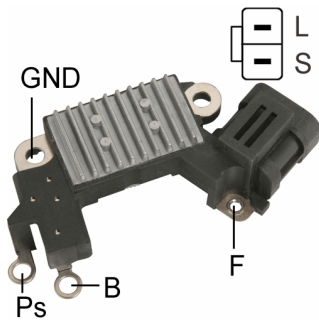

- *Repair Circuit:VR-H2000-38S
- *W/o Overvoltage/Undervoltage indication
- *W/o Short Circuit Protection
- *Voltage Set Point:14.5V

Replaces

HITACHI :
L170G-6315 L180G-23401

NISSAN :
22020-85M10 23215-0M801

Unit no.

HITACHI					
LR165-711	LR165-711B	LR170-743	LR170-745	LR170-745B	LR170-746E
LR170-746F	LR170-746G	LR170-746J	LR170-750C	LR170-750E	LR170-752
LR170-752B	LR180-741B	LR190-432	LR190-725B	LR190-725E	

VR-H2000-38SC

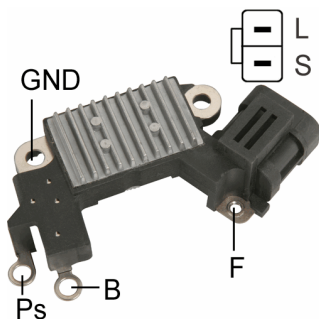

- *Repair Circuit:VR-H2000-38SCS
- *Overvoltage/Undervoltage indication
- *Short Circuit Protection
- *Voltage Set Point:14.5V

VR-H2000-39

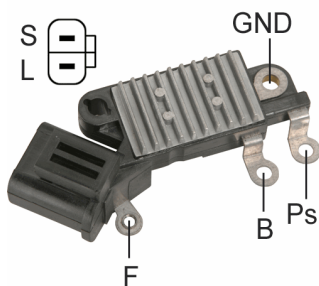

- *S-L Terminals
- *Soft Start
- *2.5 sec. LRC
- *Voltage Set Point:14.5V

Replaces

HITACHI :
TR1Z-108 TR1Z-108B

Unit no.

HITACHI					
LR170-501C	LR170-502B	LR170-502C	LR170-503	LR170-504	LR170-504B
LR190-504C	LR190-505C	LR190-505E	LR190-511	LR190-511B	LR190-512
LR190-512B	LR190-512C	LR190-515	LR190-515B		

VR-H2000-3A

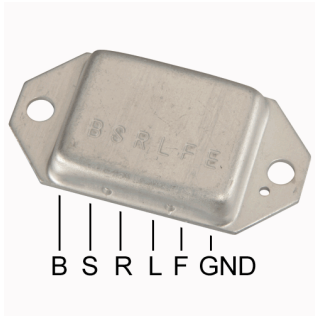

*24V
 *B-S-R-L-F-E Terminals
 *Voltage Set Point:28.3V

Replaces

HITACHI :
 TR2Z-37 TR2Z-49

ISUZU :
 8-94156-595-0

NISSAN :
 23215-C6800

Unit no.

HITACHI

LR225-403	LR225-407	LR225-408E	LR225-409B	LR225-410	LR225-412T
LR225-413T	LR225-414T	LR225-415B	LR225-418B	LR225-65P	LR225-67P
LR225-68B	LR225-80B	LR235-401	LR235-402	LR235-403T	LR235-404T
LR235-405T	LR235-406	LR235-58	LR235-70B	LR235-75C	LR235-78
LR240-34	LR240-35	LR240-401	LR240-402	LR240-404C	LR260-18B
LR260-20C	LR270-02B	LR270-03C			

ISUZU

8-94122-267-3	8-94336-728-0	8-94342-524-0	8-94389-772-1	8-94404-652-0	8-94472-330-0
8-94473-148-0	8-97013-172-2				

NISSAN

23099-C6808	23099-C8600	23099-R8111	23099-R8702	23099-S9000	23099-T9004
23100-03T03	23100-03T04	23100-04D10	23100-04D11	23100-10T06	23100-10T07
23100-11T14	23100-11T15	23100-34T04	23100-34T05	23100-C8602	23100-C8604

VR-H2000-40

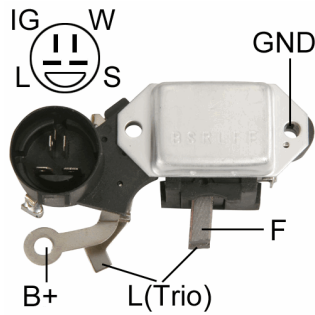

*Without capacitor
 *Voltage Set Point:14.5V

Replaces

HITACHI :
 L170G-1315

Unit no.

HITACHI
 LR170-420

VR-H2000-41

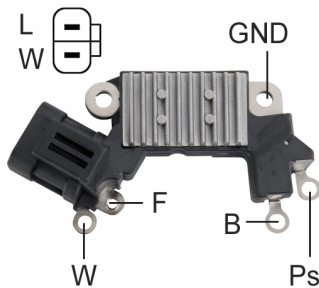

*L-W Terminals
 *Repair Circuit:VR-H2000-41S
 *Voltage Set Point:14.5V

Replaces

HITACHI :
 L170G-3319 L170G-6308 L170G-7315

VR-H2000-42

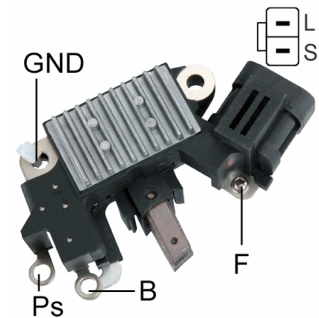

*L-S Terminals
 *Same as VR-H2000-38 but W/Brush Holder
 *Voltage Set Point:14.5V

Replaces

HITACHI :
 L170G-6315 L180G-23401 L190G-7340
NISSAN :
 23215-5V100 22020-85M10 23215-0M810

Unit no.

HITACHI
 LR165-711 LR165-711B LR170-743 LR170-745,B LR170-746E LR170-746F
 LR170-746G LR170-746J LR170-750C,E LR170-752,B LR180-741 LR190-725B,E
 LR190-732

VR-H2000-43

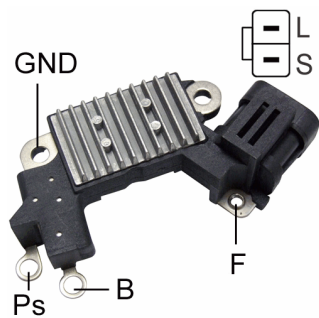

*L-S Terminals
 *Soft Start
 *4.5 sec. LRC
 *Short Circuit Protection
 *Voltage Set Point:14.2V

Replaces

HITACHI :
 L190G-5340
NISSAN :
 23215-0W402

Unit no.

HITACHI
 LR180-751 LR190729 LR190737 LR190737E
NISSAN
 23100-0W000 23100-0W001 23100-0W002 23100-0W004 23100-3M200

VR-H2000-44

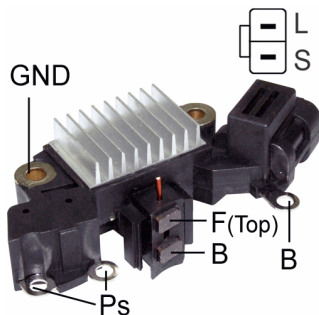

- *L-S Terminals
- *Repair Circuit: VR-H2000-44S
- *2.5 sec. LRC
- *Short Circuit Protection
- *Voltage Set Point:14.5V

Unit no.

HITACHI			
LR1100-722	LR180-756B		
NISSAN			
23100-3S500	23100-4S100	23100-9E000	

VR-H2000-45

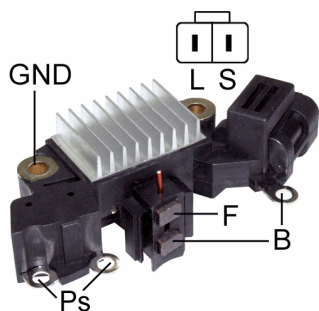

- *L-S Terminals
- *Same as VR-H2000-44 but LRC=8.5sec
- *For use on NISSAN SENTRA 180
- *Voltage Set Point:14.5V

Unit no.

HITACHI			
LR180-769			
NISSAN			
21300-4Z400			

VR-H2000-46

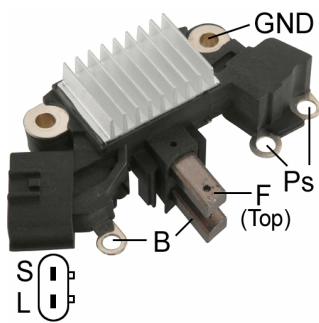

- *S-L Terminals
- *Inactive Lamp
- *Soft Start
- *8.5 sec. LRC
- *Short Circuit Protection
- *Voltage Set Point:14.5V

Replaces

HITACHI :			
L1100G-53402	L1100G-8340	L1110G-43402	
NISSAN :			
23100-2Y000	23215-2Y005	23215-0L701	23215-2Y001

Unit no.

HITACHI			
LR1100-711B	LR1110-707G	LR1110-709B	LR1110-710E

VR-H2000-47

*Voltage Set Point:14.5V

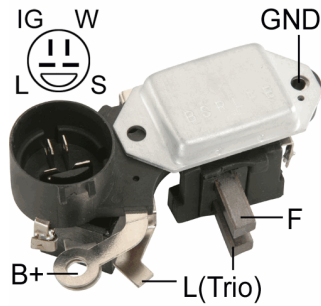

Replaces

HITACHI :
L170G-1315

MAGNETI MARELLI :
940038067

VR-H2000-48

*Soft Start
*4.5 sec. LRC
*Short Circuit Protection
**"C" Terminal connect to Computer
*Voltage Set Point: 14.6V

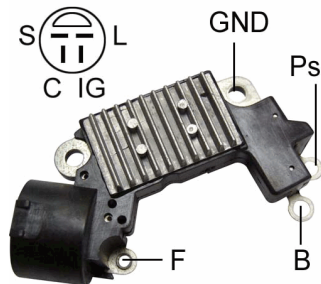

Replaces

HITACHI :
234289

Unit no.

HITACHI

LR160-630C	LR160-729C	LR160-730C	LR160-731	LR170-755
------------	------------	------------	-----------	-----------

ISUZU

2-90276-600-0	8-97101-816-2	8-97120-752-0	8-97130-776-0
---------------	---------------	---------------	---------------

VR-H2000-4H

*L-S Terminals
*Repair Circuit: VR-H2000-10S
*Voltage Set Point:14.5V
*w/o capacitor

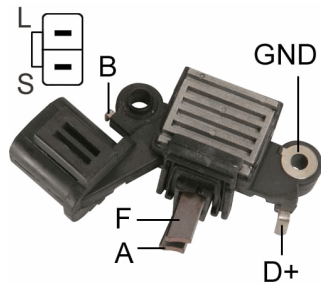

Replaces

HITACHI :
L180-3315 L190-3315

NISSAN :
23133-16E05 23133-F6100

Unit no.

HITACHI

LR170-704	LR170-713	LR170-721	LR180-704	LR190-704	LR190-709
-----------	-----------	-----------	-----------	-----------	-----------

VR-H2000-50

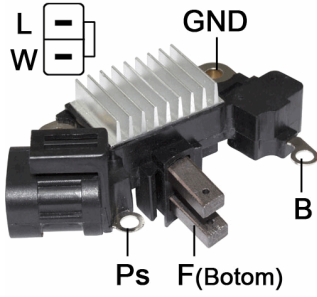

- *L-W Terminals
- *Soft Start
- *2.5 sec. LRC
- *Short Circuit Protection
- *Voltage Set Point: 14.4V

Replaces

HITACHI :
232443

Unit no.

HITACHI
LR1100-502F LR170-509E LR170-511
ISUZU
8-97189-112-3 8-97189-113-4

VR-H2000-51

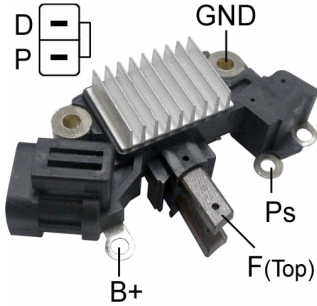

- *P-D Terminals
- *Repair Circuit: VR-H2000-51S
- **Traditional test method will immediately damage P-D regulator. Avoid damage using Mobiletron VR-H2009-66TF test fixture

Unit no.

HITACHI
LR170-758

VR-H2000-52

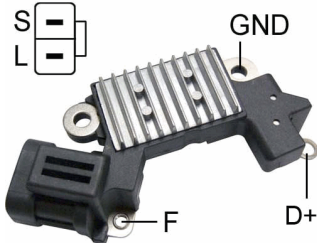

- *S-L Terminals
- *Repair Circuit: VR-H2000-52S
- *Voltage Set Point: 14.3V

Unit no.

KIA
OK012-18300 OK241-18300

VR-H2000-53

*Same as VR-H2000-41 but with Over/Under Voltage Indication

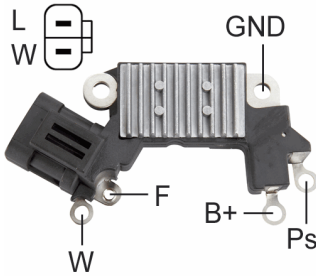

Replaces

HITACHI :

L170G-3319

L170G-6308

L170G-7315

VR-H2000-55B

*24V
 *L Terminal Does Not Drive Choke
 *Repair Circuit: VR-H2000-55S
 *Voltage Set Point:28.5V

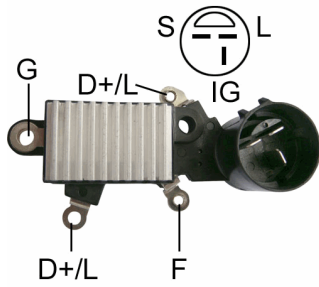

Unit no.

HITACHI

LR250-502C

LR250-507

LR250-507C

ISUZU

8-97075-883-2

8-97148-496-0

8-97148-496-1

VR-H2000-56

*L Terminal Does Not Drive Choke
 *Load Response Control
 *Soft Start
 *Short Circuit Protection
 *Voltage Set Point:14.2V

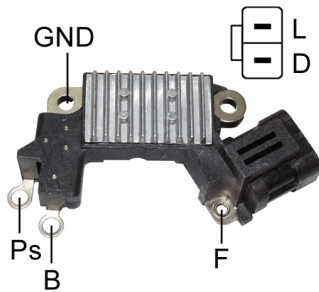

Unit no.

HITACHI

LR180-509C

LR180-510

ISUZU

29027-68100

89711-66973

89718-95490

89718-96490

VR-H2000-57

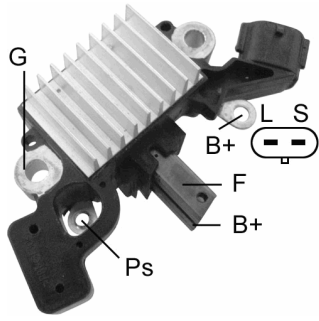

- *S-L Terminals
- *Soft Start
- *Short Circuit Protection
- *Voltage Set Point:14.3V

Unit no.

HITACHI
LR165-713

VR-H2000-5H

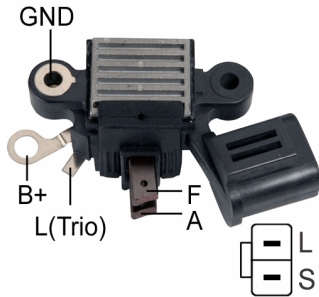

- *L-S Terminals
- *Repair Circuit: VR-H2000-5S
- *Voltage Set Point:14.5V

Replaces

HITACHI :
L160-43154 L170-53151

NISSAN :
23133-58S00 23133-58S01 23133-D4400

Unit no.

HITACHI
LR160-715 LR170-715 LR170-715B LR170-716 LR170-716B LR170-717
LR170-727 LR180-715 LR180-719

NISSAN
23100-53A00

VR-H2000-62

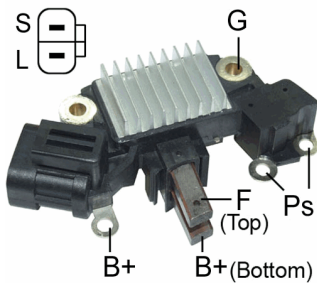

- *A-Circuit
- *Inactive Lamp
- *S-L Terminals
- *Soft Start
- *Short Circuit Protection
- *Voltage Set Point: 14.3V

Replaces

HITACHI :

L180G-63401 L185G-5340 L190G-8340

SUBARU :

23812-AA000

Unit no.

HITACHI

LR1100-705E	LR1100-710	LR1100-710B	LR160-728E	LR170-749F	LR180-749C
LR180-749E	LR190-730C	LR190-734C	LR190-734E	LR190-744	LR1110-713
LR1110-713B	LR1110-717	LR1110-717B			

ISUZU

29027-68300 89720-43320

VR-H2000-63

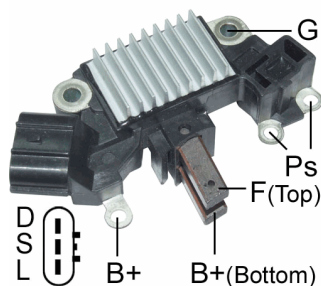

- *D-S-L Terminals
- *Soft Start
- *8.5 sec. LRC
- *Short Circuit Protection
- *Voltage Set Point: 14.3V

Unit no.

HITACHI

LR190-742

SUBARU

23700-AA31A

VR-H2000-64

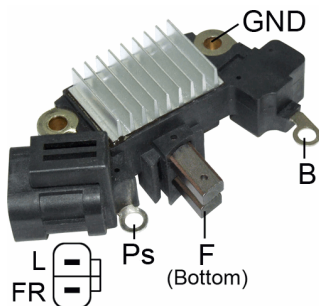

- * L-FR Terminals
- * L Terminals Does Not Drive Choke
- * W/ Short Circuit Protection
- * Soft Start
- * 2.5 sec LRC
- * Voltage Set Point: 14.3V

Replaces

OPEL :	13117236	13153236	135546130	135546140	93180104	1204434
SAAB :	12759595					

Unit no.

HITACHI	LR1100-508	LR1100-508B	LR1100-508C	LR1100-508F	LR1110-503	LR1110-503F
---------	------------	-------------	-------------	-------------	------------	-------------

Used On

OPEL		
Vectra 1.9 CDTI		2004-
Vectra C Estate 1.9 CDTI		2004-
SAAB		
9-3 1.9 TiD	YS3F	2004-
9-3 Convertible 1.9 TiD	YS3F	2006-
9-5 Estate 1.9 TiD		2005-
9-5 1.9 TiD	YS3E	2006-
9-5 Estate 1.9 TiD	YS3E	2006-

VR-H2000-6H

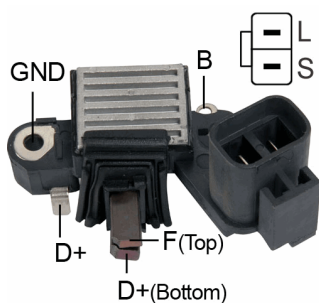

- *S-L Terminals
- *Repair Circuit: VR-H2000-13S
- *Voltage Set Point:14.5V

Replaces

HITACHI :	L170-1315			
NISSAN :	23133-04P01			
Unit no.				
HITACHI	LR170-701	LR170-701B	LR170-702	LR170-702B
NISSAN	23100-05P01	23100-05P03	23100-14P01	23100-15P01

VR-H2000-70B

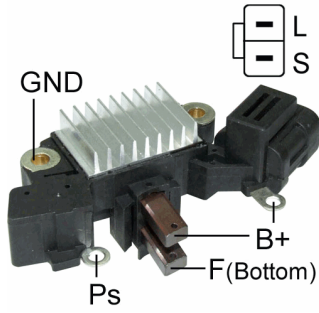

- *24V
- *Soft Start
- *Short Circuit Protection
- *Voltage Set Point: 28.5V

Unit no.

HITACHI		
LR280-501	LR280-506	LR280-508
ISUZU		
8-97248-914-1	8-97332-502-0	8-97351-574-0

VR-H2000-71

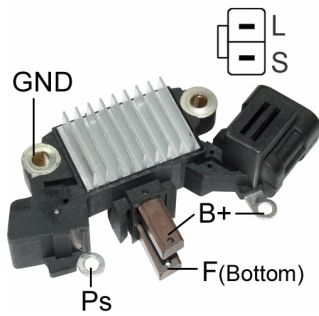

- *Soft Start
- *Short Circuit Protection
- *S Open Lamp Off
- *Voltage Set Point: 14.5V

Unit no.

HITACHI		
LR1110-501		

VR-H2000-72

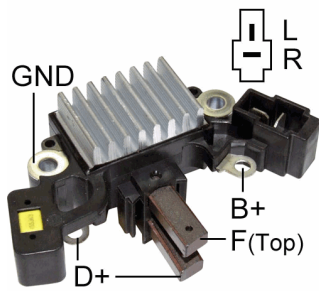

- *Voltage Set Point: 14.5V

Replaces

HITACHI :
IH784

Unit no.

HITACHI		
LR140-721	LR140-721B	LR140-721C
YANMAR		
129930-77211		

VR-H2000-73

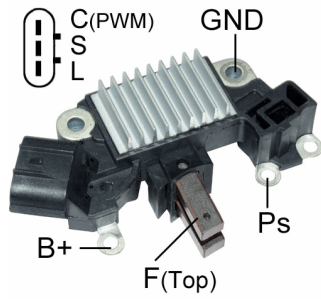

- *Soft Start
- *Short Circuit Protection
- *Voltage Set Point: 14.3V
- *Regulated Voltage Control(RVC)
- *Requires VR-RVC01 test adaptor for testing

Unit no.
 HITACHI
 LR1110-724 LR1110-724B

VR-H2000-74

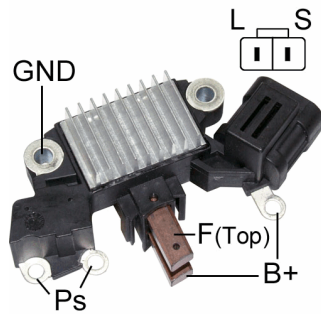

- *L-S Terminals
- *Soft Start
- *Short Circuit Protection
- *Voltage Set Point: 14.5V

Unit no.
 HITACHI
 LR1100-715

VR-H2000-75B

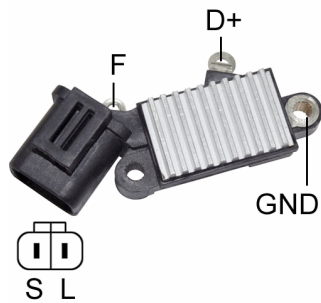

- *24V
- *Voltage Set Point: 28.5V

Unit no.
 NISSAN
 23100-0T002

VR-H2000-7H

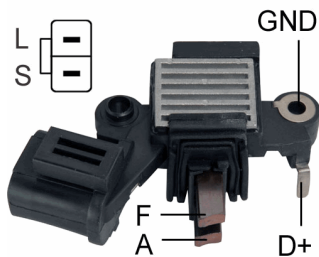

- *S-L Terminals
- *Repair Circuit: VR-H2000-19S
- *Voltage Set Point:14.5V
- *w/capacitor

Replaces

HITACHI :
L180-7315

NISSAN :
23133-26E60

Unit no.

HITACHI

LR170-721B LR180-721B LR190-704B LR190-709B LR190-711

VR-H2000-8

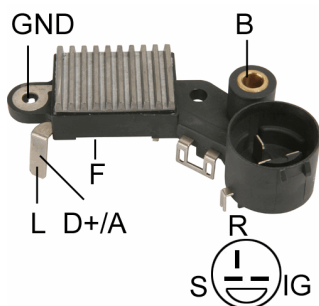

- *S-L Terminals
- *Voltage Set Point:14.5V

Replaces

HITACHI :
TR1Z-210A TR1Z-210B

Unit no.

HITACHI

LR155-502B LR155-502C LR155-502E LR155-503E LR155-504

VR-H2000-80B

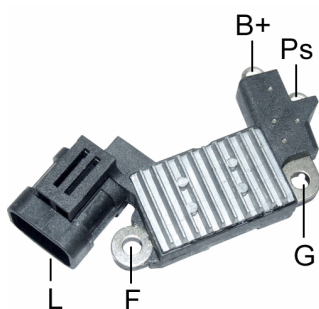

- *24V
- *Soft Start
- *Short Circuit Protection
- *Voltage Set Point 28.4V

Unit no.

HITACHI

LR250-508 LR250-707

VR-H2000-84

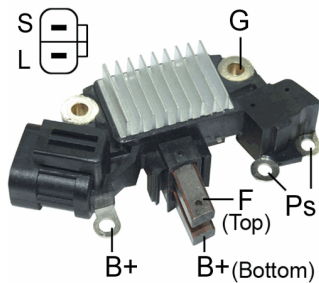

- *S-L Terminals
- *Soft Start
- *2.5 sec. LRC
- *Short Circuit Protection
- *Voltage Set Point: 14.3V

Unit no.
 HITACHI
 LR1110-713V
 NISSAN
 23100-AU400

VR-H2000-85

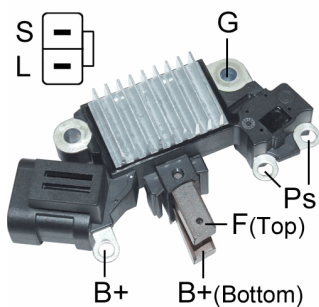

- *Soft Start
- *8.5 sec. LRC
- *Short Circuit Protection
- *Voltage Set Point: 14.3V

Replaces
 HITACHI :
 IH746
 Unit no.
 HITACHI
 LR1130-701
 NISSAN
 23100-8S100 23100-8S10A

VR-H2000-86B

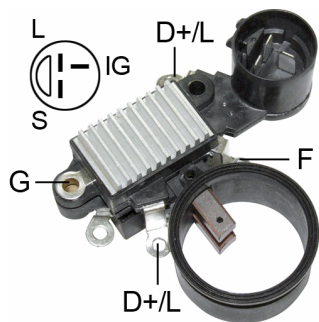

- *24V
- *Voltage Set Point: 28.5V
- *Same as VR-H2000-55 w/brush holder

Unit no.
 HITACHI
 LR250-502C LR250-507 LR250-507C
 ISUZU
 8-97075-883-2 8-97148-496-0 8-97148-496-1

VR-H2000-87

*Voltage Set Point: 14.4V

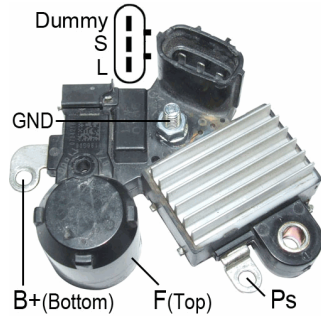

Unit no.
 HITACHI
 LR1140-803E LR190-772 LR190-773
 NISSAN
 23100-ED50A

VR-H2000-88

*Soft Start
 *Short Circuit Protection
 *S Open Lamp On
 *Voltage Set Point: 14.3V

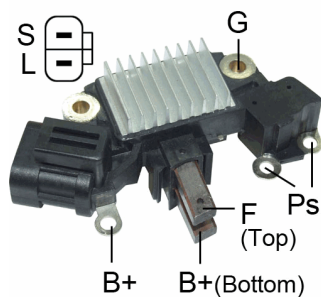

Replaces
 HITACHI :
 L180G-63401 L190G-8340
 NISSAN :
 23215-0V000 23215-2J602
 Unit no.
 HITACHI
 LR1110-713C
 NISSAN
 23100-AU400

VR-H2000-9

*S-IG-L Terminals
 *Repair Circuit: VR-H2000-9S
 *Voltage Set Point: 14.5V

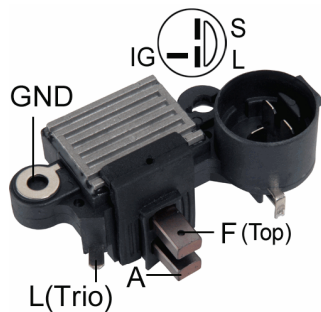

Replaces
 ISUZU :
 8-94462-849-0
 Unit no.
 HITACHI
 LR150-704 LR150-704H LR160-718 LR160-718H
 ISUZU
 8-94136-210-0 8-94449-265-0 8-94449-731-0

VR-H2000-91

- *Soft Start
- *Short Circuit Protection
- *Voltage Set Point: 14.3V
- *Regulated Voltage Control(RVC)
- *Requires VR-RVC01 test adaptor for testing

Unit no.

HITACHI

LR140-803

LR140-806

LR140-807

NISSAN

23100-ED500

Used On

NISSAN

Tiida

VR-IK01

*Voltage Set Point:14.2V

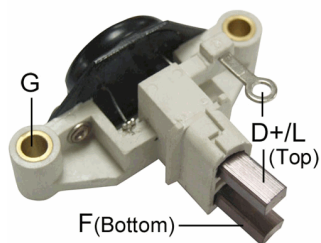

Replaces

ISKRA :

11-125-165 16-906-481

Unit no.

ISKRA

11201666 11201667 AAK5114 AAK5115

VR-IK019

*32mm OD
*Voltage Set Point:14.7V

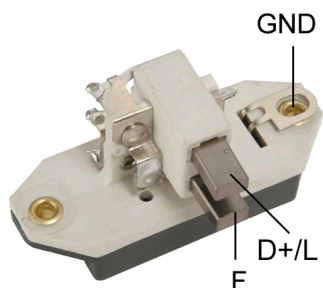

Replaces

ISKRA :

11125019	11125053	11125054	11125056	11125065	11125085
16905323	AER1401	AER1406	AER1505	AER1506	AER1508
AER1510	11125139	11125177	11125199		

Unit no.

ISKRA

11201273 AAK1314

VR-IK02

*Voltage Set Point: 14.6V

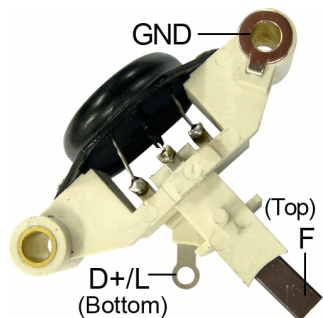

Replaces

ISKRA :

11-125-124 16-906-352

Unit no.

ISKRA

11201440	11201498	11201534	11201769	AAK5102	AAK5105
AAK5108	AAK5136				

VR-IK029

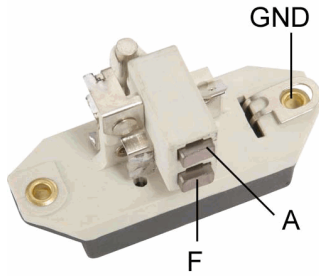

*24V
 *32mm OD
 *Voltage Set Point:28.3V

Replaces

ISKRA :

11-125-029	11-125-047	11-125-087	16-905-304	AER1404	AER1504
AER1511					

Unit no.

ISKRA

11201050	11201052	11201055	11201066	11201069	11201087
11201098	11201107	11201151	11201162	11201186	11201201
11201360	11201522	11201555	11201557	11201574	11201586
11201633	11201635	11201699	11201705	AAK1107	AAK1109
AAK1110	AAK1113	AAK1115	AAK1125	AAK1131	AAK1134
AAK1153	AAK1160	AAK1167	AAK1309	AAK1347	AAK1352
AAK1367	AAK3520	AAK3557	AAK4179	AAK4507	AAK4509
AAK4531	AAK4560				

VR-IK149

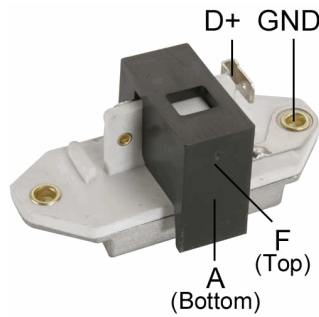

*Voltage Set Point:14.2V

Replaces

ISKRA :

11-125-122	11-125-149	11-201-293	AER1528	AER1543
------------	------------	------------	---------	---------

LADA :

21083701010	224370701	T2223701010
-------------	-----------	-------------

Unit no.

ISKRA

AAK4127

VR-JD357

*Voltage Set Point: 14.5V

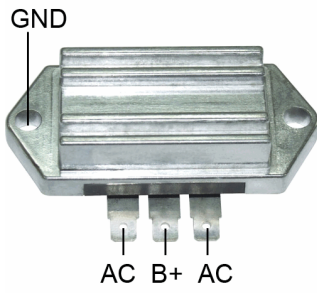

Replaces

JOHN DEERE :

AM102596 AM123296 AM106357 AM34738

VR-H2009-116

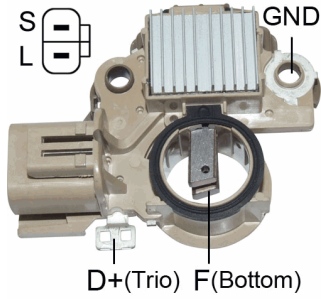

- * Inactive Lamp
- * S-L Terminals
- * Voltage Set Point:14.5V

Replaces

KIA :

OK201-18-300B OK24A-18-300A OK29T-18-300

MANDO :

AB170036 AB170066 AB180092 TA500C02001A TA500C02701

VALEO :

234252

Used On

KIA

Sephia 1.6L 1993-1995

VR-K01

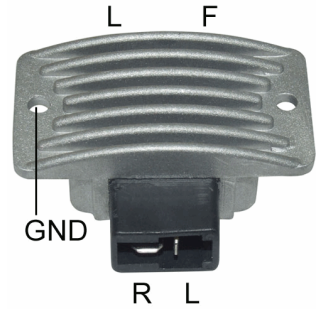

- *Voltage Set Point:14.7V

Unit no.

POONG SUNG

02121-8025 02121-8027 02121-8070 02121-8071 02121-8073 02121-8074
 02121-9012 02121-9020 02121-9021 02121-9022

Used On

KIA

Retona 2.0 TD
 Sportage 2.0 TD 4WD

VR-K01B

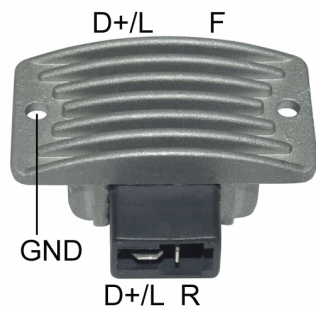

- *24V
- *Voltage Setting:28.3V

Unit no.

POONG SUNG

02122-3030

VR-K02

*Voltage Set Point: 14.5V



Unit no.

HYUNDAI
37300-12470

KIA
OK72A-18-300

POONG SUNG
02131-9020 02131-9021

VR-K05

*S-L Terminals
*Voltage Set Point: 14.3V

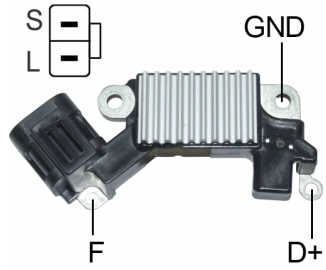

Replaces

KIA :
37370-27011

POONG SUNG :
235522

Unit no.

HYUNDAI				
37300-27011	37300-27012	37300-27013	37300-27030	37300-27031
POONG SUNG				
02131-9111	02131-9112	02131-9311		

Used On

HYUNDAI

Elantra 2.0L 16V	2001-ON
Santa FE 2.0L 16V	2001-ON

KIA

Sportage 2.0L	2005-ON
---------------	---------

VR-LD150A

*Voltage Set Point:14.5V

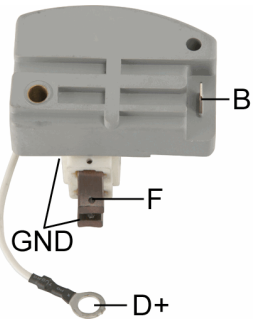

Replaces

LADA :			
173701010	21033701500	21053701500	
LUCAS :			
21129167	21229167	UCB900	
MAGNETI MARELLI :			
940038112			

Unit no.

LADA	
2105-370-1010	2205-370-1005

VR-LD160

*Voltage Set Point:14.5V

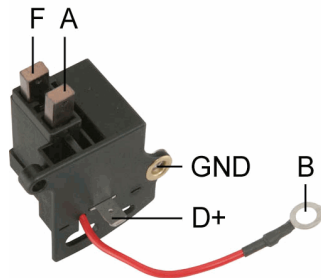

Replaces

LADA :			
173702	21083701500	56-7-625/5	EP1
LUCAS :			
21229189	UCB902		

VR-LC100

*Voltage Set Point:14.5V

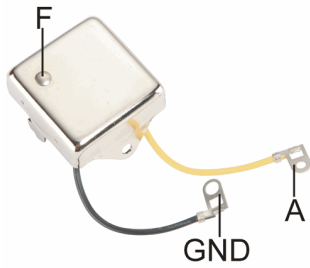

Replaces

BL/JAGUAR :

37H6911	520076	607687	AAU4842	ABU9969	BAU4443
JS485					

BOSCH :

0-986-192-006

LUCAS :

37534	37538	37541	37555	37558	37561
37565	37566	37581	37587	37612	37628
37639	37647	37653	37657	37672	37679
37683	UCB100	UCB100X	UCB114		

MASSEY FERGUSON :

1887416M1 1897383M1

MOTORCRAFT :

EGR304 EGR351

TALBOT :

75062449

VALEO :

505044	505052	505096	A554616A	NB180
--------	--------	--------	----------	-------

VALEO(MOTOROLA) :

9RC7037

Unit no.

LUCAS

23562	23563	23565	23566	23572	23581
23582	23584	23589	23590	23592	23593
23602A	23602B	23603	23606	23615	23617
23620	23634	23636	23637	23638	23640
23644	23646	23647	23648	23674	23675
23682	23685	23700	23709	23713	23715
23716	23718	23725	23726	23729	23730
23734	23737	23765	23774	23775	23801
23802	23808	23842	23850	23851	23852
23888	23963				

VR-LC106

*L Terminal Does Not Drive Choke

*Voltage Set Point:14.4V

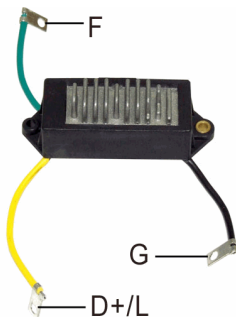

Replaces

LUCAS :

26215045 SR30

Used On

SUZUKI

Maruti 800

VR-LC107

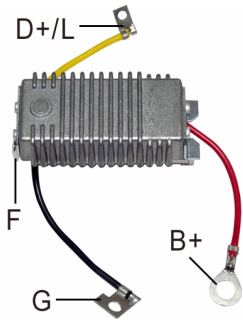

*L Terminal Does Not Drive Choke
 *Voltage Set Point:14.4V

Replaces

LUCAS :
 26938068B TR15

Used On

TATA
 407 Truck

VR-LC108

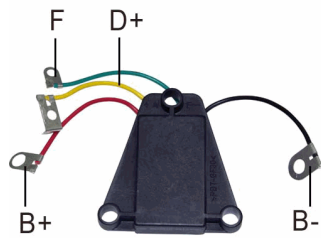

*L Terminal Does Not Drive Choke
 *Voltage Set Point:27.8V

Replaces

LUCAS :
 26938063A SR40

Used On

LEYLAND/DAF
 Truck

VR-LC110

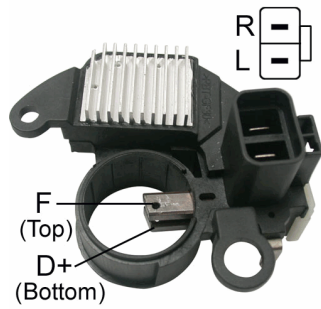

*L Terminal Does Not Drive Choke
 *Voltage Set Point:14.6V

Replaces

LUCAS :
 26214105 GA15

Used On

HYUNDAI
 Santro

VR-LC111

*Voltage Set Point:14.5V

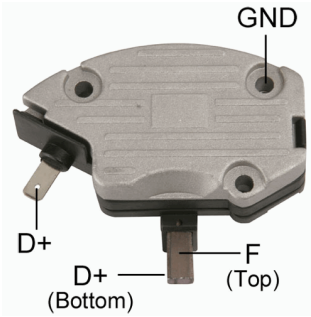

Replaces

CASE :

K262266

DELCO REMY (LUCAS) :

54048473

FORD :

6133746 84AB-10316AA

LUCAS :

37701	37703	37705	37707	54048473	54048600
54205986	54206177	54206448	54206467	54206645	54207336
54208417	UCB148	UCB148X	UCB150	UCB150X	UCB151
UCB151X	230283	37707A	54206688	UCB152	28000010
28001010	66201555				

MAGNETI MARELLI :

28000 28001 28000010

MASSEY FERGUSON :

1865974M1 1897699M91 345773M91 3474604M91 3476714M91

NISSAN :

23133-Q9000

PERKINS :

28710252

ROVER :

BAU4919	BAU5265	BAU5958	FBU2243	FBV2243	RTC5044
RTC5370	RTC5670				

RVI :

5430021883

VALEO :

A554711A

Unit no.

LUCAS

24145	24145AD	24156	24156AD	24157	24157AD
24158	24161	24169	24169AE	24188AC	24198
24198AB	24199	24199AB	24200	24200A	24202
24203	24203A	24206	24206AB	24207	24207A
24208	24208AB	24209AB			

NISSAN

23100-71J00

VR-LC111B

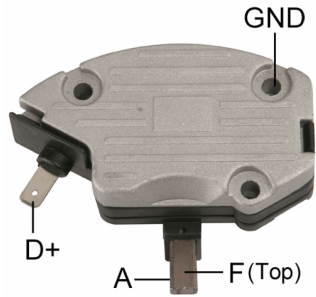

*24V
*Voltage Set Point:28.3V

Replaces

LUCAS :
28002 54022415 84959 UCB155

Unit no.

LUCAS
24299 24406 A127 NAB901 NAB903

VR-LC112

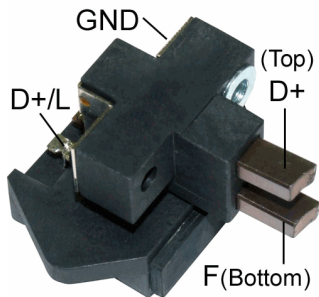

*A-Circuit
*Inactive Lamp
*Voltage Set Point:14.3V

Replaces

LUCAS :
2193818A SR60

Used On

TATA
Indica
Indigo

VR-LC113L

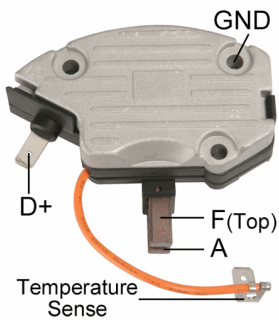

*Voltage Set Point:12.5V

Replaces

FORD :
E3NN-10B376AD E7NN-10316AA

LUCAS :
37735 UCB153

Unit no.

FORD
E8NN-10316
LUCAS
24246A 24256AC 24258A 24262A 24273 24273A
24274A 24276 24277 24278A 24279A 24295A
LRA522 LRA530

VR-LC115

*Voltage Set Point: 14.4V

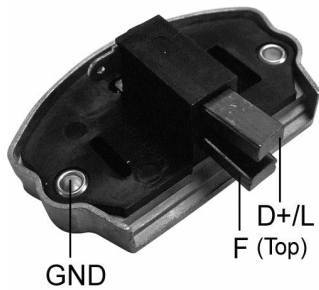

Replaces

LUCAS :
35381720

Unit no.

LUCAS
35213795 35213940 35213995 35214100

VR-LC200

*Voltage Set Point: 14.5V

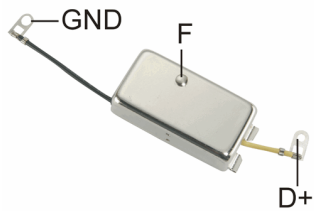

Replaces

BL/JAGUAR :

AEU1526 AEU1669 AEU1915 AEU2750 AEU4007A BBU2117
BBU3021 BBU3773

FORD :

1591687 81DB-10316CA

LUCAS :

37624 37636 37640 37659 37661 37666
37667 37684 37686 37690 37709 UCB124X
UCB126 UCB129 UCB129X UCB133 UCB133X UCB134
UCB134X UCB137 UCB139 UCB142

MAGNETI MARELLI :

940038132

MASSEY FERGUSON :

1897266M1 1897294M1 3473155M1 3473593M1

MOTORCRAFT :

EGR311 EGR313

Unit no.

LUCAS
23970 23971 23996 24011 24029 24030
24037 24049 24056 24061 24087 24096
24101 24102 24115 24142 24173 24229
24238

VR-LC201

*Voltage Set Point:14.5V

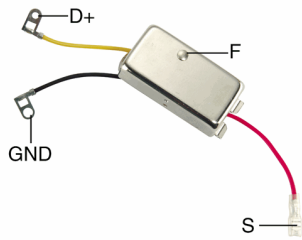

Replaces

LUCAS :
 37621 37659 37684 UCB126
MOTORCRAFT :
 EGR314

Unit no.

LUCAS
 23996 24049 24096 24115

VR-LC301

*Voltage Set Point:14.2V

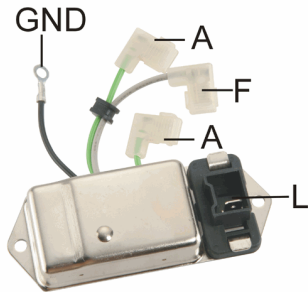

Replaces

INDIEL :
 35381600
NOSSO :
 ID112V

Unit no.

FORD
 SIERRA2.3

VR-LC302

*Voltage Set Point:14.2V

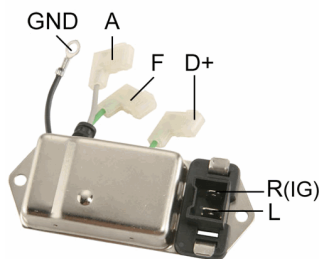

Replaces

INDIEL :
 35381400 35381690
NOSSO :
 ID212V

Unit no.

RENAULT
 R11 R18

VR-LC303

*Voltage Set Point:14.2V

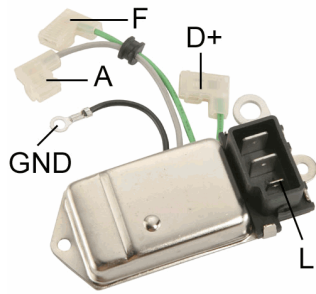

Replaces

INDIEL :
35381540 35381605

NOSSO :
ID312V

Unit no.

FORD
SIERRA1.6 SIERRA2.3

VR-LC303B

*24V
*Voltage Set Point:28.3V

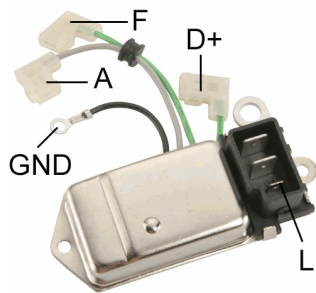

Replaces

INDIEL :
35381640

NOSSO :
RNI-1640

VR-LC304

*Voltage Set Point:14.2V

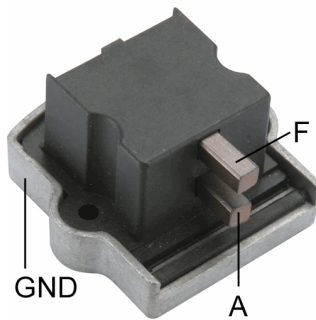

Replaces

INDIEL :
35381130 35381512

NOSSO :
IF12V

VR-LC304B

*24V
*Voltage Set Point:28.3V

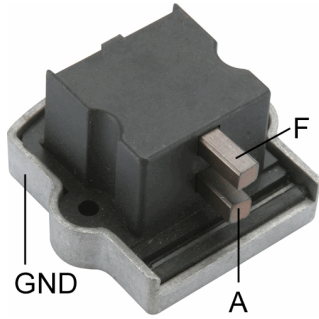

Replaces

INDIEL :
35681175
NOSSO :
IF24V

VR-LC304NB

*24V
*Voltage Set Point:28.3V

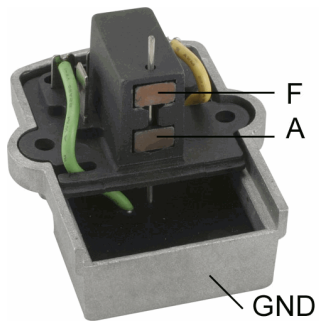

Replaces

INDIEL :
35381680
NOSSO :
RNI1680

VR-LC305

*Voltage Set Point:14.5V

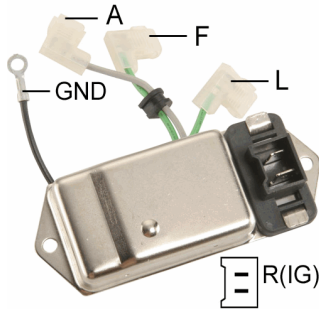

Replaces

INDIEL :
35381630

VR-F110A

*Voltage Set Point:14.7V

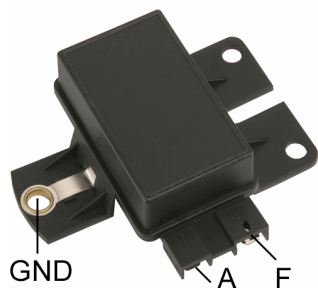
**Replaces****BOSCH :**

9-190-110-032 9-190-333-707

ELMOT :

RC212B RC212D RC212E

FEMSA :

GRO12-3Y GRO12-X1Y GRO12-X30 RFH12-11 RFH12-7

FIAT :

4074763 4095889 4095898 4191122 4202969 4296100

4474566 5011933

ISKRA :

11-125-110 AER3007

LADA :

21013702000

MAGNETI MARELLI :

63408004 63408005 63408007 63472000 64808020 64808101

64808103 RTT110B RTT110BBJ RTT110BJ

VALEO :

505050 505051 505053

VALEO(MOTOROLA) :

9RH7021 9RH7029 9RH7044

VR-F110B

*24V

*Voltage Set Point:28.3V

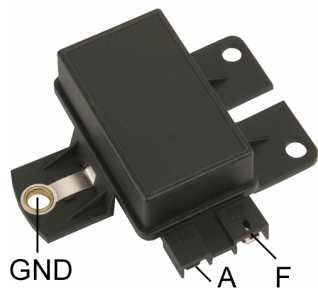
**Replaces****BOSCH :**

9-190-333-704

ELMOT :

RC128 RC224

FEMSA :

RFH24-4

FIAT :

4087071 4112453 4205243 4215948 4288170 4296659

4474531 4701050 4754010

ISKRA :

11-125-091 AER3001

LUCAS :

2193008 NCB811

MAGNETI MARELLI :

63408305 63408306 64808102 64808108 RTT110C RTT110CCJ

RTT110J

VALEO :

505054

VALEO(MOTOROLA) :

9RH8043

VR-F113A

*Voltage Set Point:14.7V

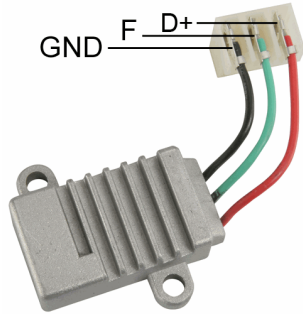

Replaces

FIAT :

4474966

LUCAS :

21222128 UCB809

MAGNETI MARELLI :

64808130 99908140 RTT113A

Unit no.

MAGNETI MARELLI

63303501	63303502	63303522	63303700	63303701	63303702
63303703	63303720	63303721	63303722	63303731	63303733
63303780	63303790				

VR-F113B

*24V

*Voltage Set Point:28.3V

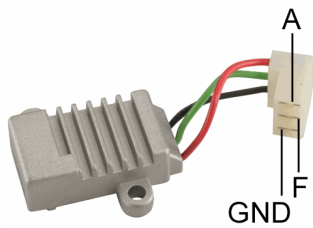

Replaces

FIAT :

9986111

LUCAS :

21222130 UCB810

MAGNETI MARELLI :

64808132 RTT113 RTT113B

Unit no.

MAGNETI MARELLI

63301201	63301241	63304480	63304500	63304520	63304530
63304550	63304560	63304570	63304580	79014078	

VR-F114A

*A-Circuit
 *Inactive Lamp
 *Voltage Set Point:14.5V

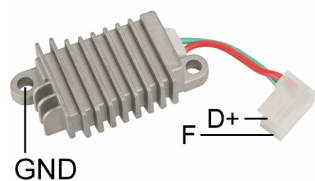

Replaces

BOSCH :

0-986-192-005

FIAT :

4475112 4721593

LUCAS :

21222081 21222106 21932004 UCB802 UCB805

MAGNETI MARELLI :

64808106 64808140 64808143 RTT114A

Unit no.

FIAT

4393206 4395131 5920974

MAGNETI MARELLI

63300905	63300925	63305100	63305101	63305102	63305103
63305120	63305122	63305123	63305130	63305131	63305150
63305226	63305236	63305246	63305256	63305270	63305310
63305400	63305401	63305402	63305403	63305404	63305405
63305406	63305420	63305423	63305425	63305426	63305430
63305431	63305440	63305442	63305450	63305506	63305526
63305536	63305556	63305566	63305621	63305700	63305701
63305702	63305711	63305712	63305720	63305730	63305800
63305801	63305802	63305820	63305821	63305822	63305832
63305842	63305862	63305900	63306700	63306701	63306721
63306730	63307100	63307101	63307103	63307105	63307106
63307108	63307120	63307123	63307125	63307126	63307127
63307128	63307130	63307131	63307150	63307160	63307206
63307207	63307208	63307218	63307227	63307236	63307246
63307256	63307270	63307310	63307400	63307403	63307405
63307406	63307407	63307408	63307410	63307420	63307423
63307428	63307429	63307430	63307431	63307441	63307442
63307450	63307452	63307460	63307470	63307490	63307503
63307506	63307508	63307509	63307518	63307523	63307526
63307536	63307556	63307566	63307602	63307604	63307622
63307634	63307801	63307802	63307804	63307821	63307822
63307824	63307841	63307842	63307851	63307862	63307872
63308701	63308721	63308731	62307526	63305206	63305400
63305401	63305403	63305404	63305405	63307401	AA125-14V-55A-V1
AA125-14V-55A-V3	AA125-14V-55A-V4	AA125-14V-55A-V5			

VR-F114B

*24V
*Voltage Set Point:28.3V

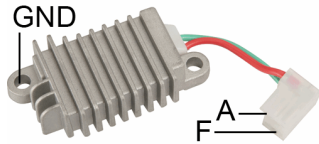

Replaces

FIAT :		
9959694	9983355	
LUCAS :		
21222119	UCB807	
MAGNETI MARELLI :		
64808141	81200270	RTT114B

Unit no.

FIAT		
4715786	4738563	
MAGNETI MARELLI		
63306000	63306300	AA125-28-30A

VR-F118

*Voltage Set Point:14.6V

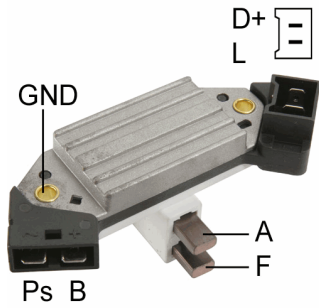

Replaces

MAGNETI MARELLI :					
64808182	64808184	64808241	64808243	83607041	83607111
RTT118C	RTT118E	RTT118J			

Unit no.

MAGNETI MARELLI					
63320027	63320039	63320041	63321057	63321081	63321083

VR-F119

*Voltage Set Point:14.7V

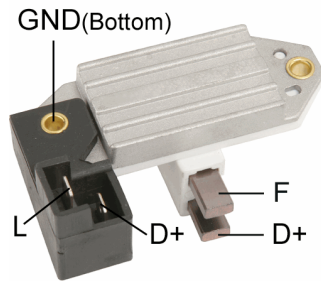

Replaces

DELCO REMY (LUCAS) :
21222127

FIAT :
9939826 9941193

ISKRA :
11125097

LUCAS :
2122121 581200220000 581200220100 21222127 UCB808

MAGNETI MARELLI :
58120022 79707161 79707481 83600151 RTT119A RTT119AAC
RTT119AC 5812002200

VALEO(DUCELLIER) :
592967

Unit no.

MAGNETI MARELLI
633-200SERIES 633-210SERIES

VR-F119B

*24V
*Voltage Set Point:28.3V

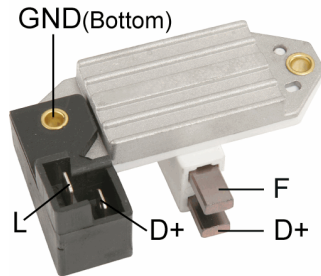

Replaces

FIAT :
8190407

LUCAS :
21222126 UCB806

MAGNETI MARELLI :
79707441 RTT119B

VALEO(DUCELLIER) :
592968

Unit no.

MAGNETI MARELLI
63320025 63320052 63320057 63320118 63321046 63321047
63321048 63321049 63321050 63321052 63321055 63321063
63321102 63321104 63321110

VR-F121

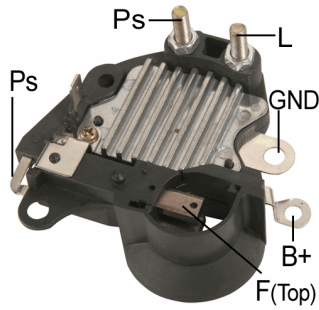

- *Soft Start
- *2.5 sec. LRC
- *Short Circuit Protection
- *Voltage Set Point:14.7V

Replaces

MAGNETI MARELLI :
28018A

Unit no.

MAGNETI MARELLI

54022459	54022469	54022470	54022606	63320228	63320289
63320312	63320313	63320314	63320315	63321240	63321243
63321253	63321258				

VR-F121T

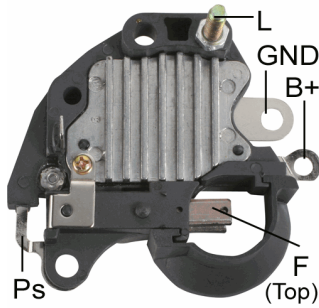

- *Soft Start
- *2.5 sec. LRC
- *Short Circuit Protection
- *Voltage Set Point:14.7V

Replaces

FIAT :
9946618 9950586

MAGNETI MARELLI :
24TR 24TR/B 54209305 83614251 RTM24TR

Unit no.

MAGNETI MARELLI
A127I

VR-F150A

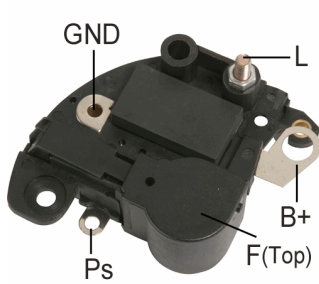

- *W/Capacitor
- *W/Choke
- *Voltage Set Point:14.7V

Replaces

MAGNETI MARELLI :
83615921 RTM150B

Unit no.

MAGNETI MARELLI
63321261 63341261 A127IM

VR-F151A

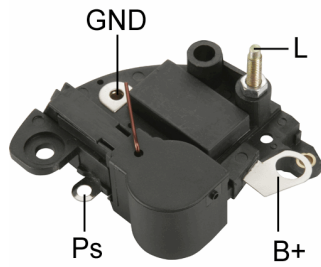

*W/Capacitor
 *W/Choke
 *Voltage Set Point:14.7V

Replaces

FIAT :

9946542

MAGNETI MARELLI :

581200530010	581200530000	501200530010	331850	85563051010	8556351010
85561291	RTM151C	RTM152A	83611361	RTM121A	RTM151A
RTM151B	85563051	58120053	000083611361	000085561291	058120056010
083611361010	083613011010	501200530000			

Unit no.

MAGNETI MARELLI

63320200	63320203	63320219	63320227	63320238	63321200
63321204	63321233	63321234	63321235	6332124	63321252
A1271	A1271R	AA1151			

VR-F153A

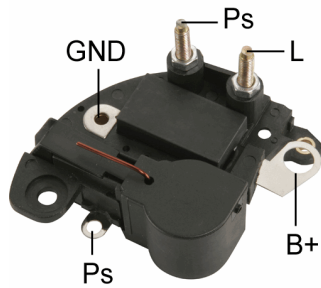

*W/Capacitor
 *W/Choke
 *Voltage Set Point:14.7V

Replaces

MAGNETI MARELLI :

83617181	RTM153B
----------	---------

Unit no.

LANDROVER

63321240

MAGNETI MARELLI

63321321	63321333	63321351	63321352	63321353	63321354
63341240	63341321	63341333	63341351	63341352	63341353
63341354	A1271M	AMR2938			

VR-F153MB

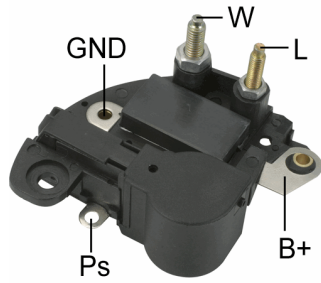

*24V
*Voltage Set Point:28.3V

Unit no. [redacted]
MAGNETI MARELLI
54022667 54022670

VR-F154

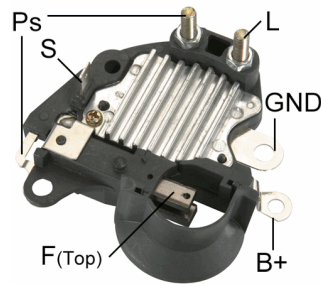

*w/battery sensor
*Voltage Set Point:12.6V

Replaces [redacted]
MAGNETI MARELLI :
54209276
Unit no. [redacted]
MAGNETI MARELLI
54022443

VR-F154B

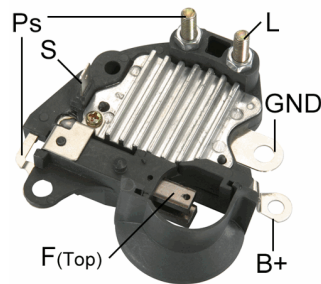

*Short Circuit Protection
*Voltage Set Point: 28.5V

Unit no. [redacted]
DENSO
102211-8140 102211-8150
MAGNETI MARELLI
63377466 63377465

VR-F155

*Voltage Set Point:14.4V

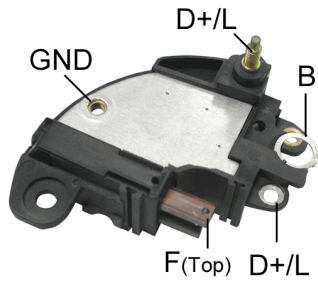

Replaces

MAGNETI MARELLI :

85562061 85563501

Unit no.

MAGNETI MARELLI

63321671 63321641 63341641 63341671

VR-F156

*Voltage Set Point:14.0V

*Regulated Voltage Control(RVC)

*Requires VR-RVC01 test adaptor for testing

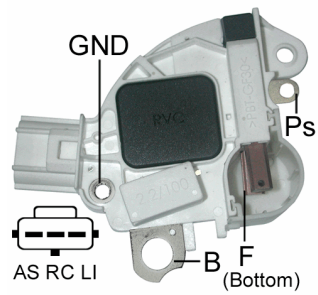

Replaces

LUCAS :

83627781010 85562541010

MAGNETI MARELLI :

83627781 85562541 85562801 85582601 940016012300 085582601010

85562541 85562801

Unit no.

FORD

98AB10300GD

MAGNETI MARELLI

63321678 63321679 63321746 63341679

VALEO(PARIS RHONE)

A115I

VR-F157

*Voltage Set Point:14.4V

*Self Exciting

*Soft Start

*W/Short Circuit Protection

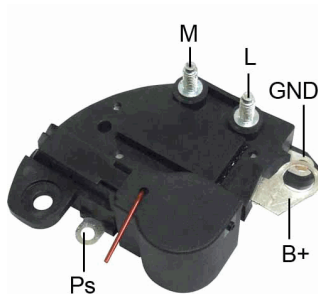

Replaces

MAGNETI MARELLI :

85563491

Unit no.

MAGNETI MARELLI

63321733 63321734 63321740 63321741 63321829 A115IM

VR-F158

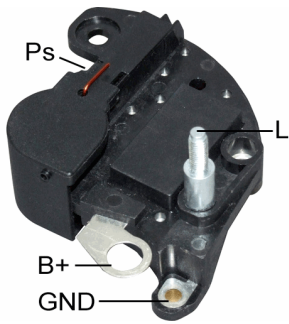

- *Voltage Set Point:14.4V
- *Soft Start
- *W/Short Circuit Protection

Replaces

MAGNETI MARELLI :

85562881 85562731

Unit no.

MAGNETI MARELLI

A127IM	63321491	63321494	63321507	63321507	63321712
63321713	63321718				

VR-F159

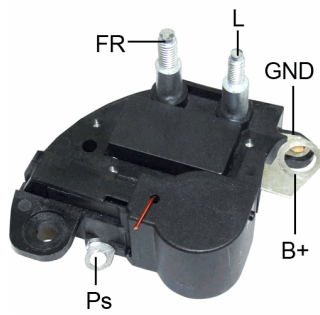

- *Voltage Set Point:14.4V
- *Soft Start
- *W/Short Circuit Protection

Replaces

MAGNETI MARELLI :

85552506

Unit no.

DENSO

102211-8611 102211-8660

FIAT

46835095 51784846

MAGNETI MARELLI

RTM200.13

VR-F160

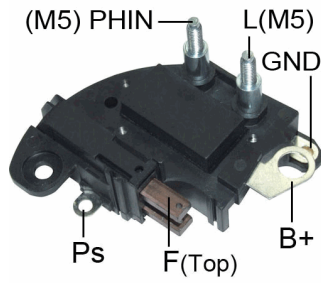

- *Soft Start
- *2.5 sec. LRC
- *Short Circuit Protection
- *PHIN : Activated terminal
- *Self Exciting
- *Voltage Set Point:14.4V

Replaces

MAGNETI MARELLI :

85563481 RTM200.03 RTM200.09

Unit no.

MAGNETI MARELLI

63321702 63321658 63320545 63320535 63341658 63341702

Used On

SMART

Cabrio 0.6	52kW	2002-2004
City Coupe	33kW	1998-2004

VR-MP134

*Voltage Set Point:14.5V

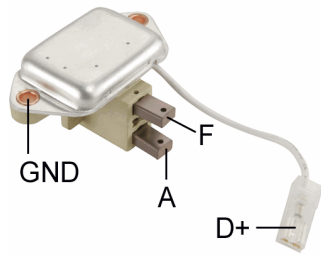

Replaces

MAGNETON-PAL :

443930134291	443930136111	443930136131	136111	143431	134291
134541	136110	136131	143411	443930134540	443930134541
443930135641	443930136110				

Unit no.

MAGNETON-PAL

443113516630	443113516631	443113516632	443113516650	443113516653
--------------	--------------	--------------	--------------	--------------

VR-MP417

*Voltage Set Point:14.5V

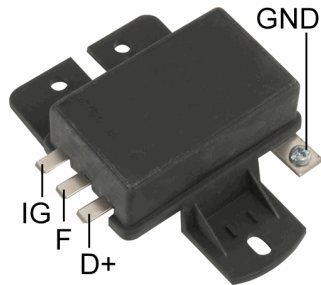

Replaces

MAGNETON-PAL :

44311641702

SKODA :

907041190

VR-MP419

*Voltage Set Point:14.5V



Replaces

MAGNETON-PAL :

443116419070 443116419071

SKODA :

907040114

VR-H2009-106

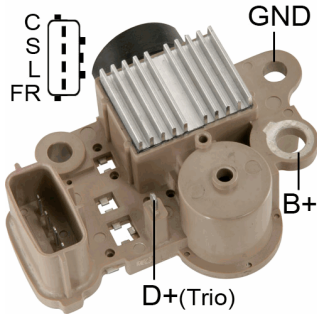

- *C-S-L-FR Terminals
- *Soft Start
- *Inactive Lamp
- *Voltage Set Point:14.3V

Unit no.

HYUNDAI
37300-38310
MANDO
AB195126

VR-H2009-86

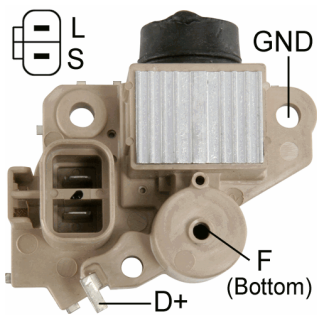

- *L-S Terminals
- *Voltage Set Point:14.2V

Replaces

KIA :
37370-22200
VALEO :
TA500C02401

Unit no.

HYUNDAI
37300-22200

VR-H2009-89

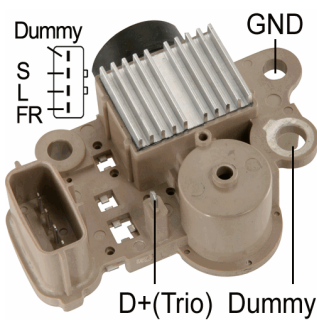

- *Dummy-S-L-FR Terminals
- *Voltage Set Point:14.3V
- *Repair Circuit:VR-H2009-89S
- *for EF SONATA

Replaces

MANDO :
TA000A29102

Unit no.

HYUNDAI
37300-38310

VR-MD01

*Voltage Set Point:14.2V

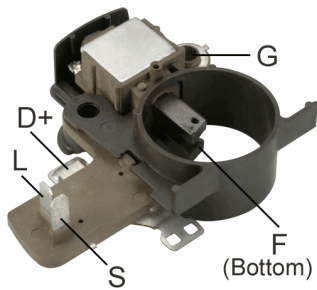

Replaces

KIA :

37370-42000 37370-42540

MANDO :

37300-42010 37300-42502 37300-42750

VALEO :

139669

Unit no.

HYUNDAI

37300-42204

VR-MD03

*Adjustable Voltage

*Black: B-

*Green:D+

*Red: Sense

*Blue: Ignition

*Orange: Field

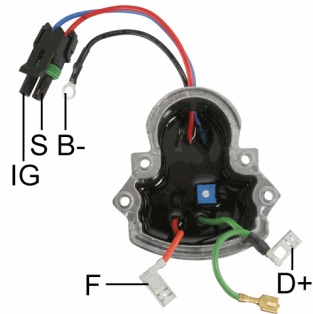

Replaces

MANDO :

12449 42786

Unit no.

MANDO

AR150BA AR150CA

VR-MD04

*Adjustable Voltage

*Black: B-

*Green:D+

*Red: Sense

*Blue: Ignition

*Orange: Fiel

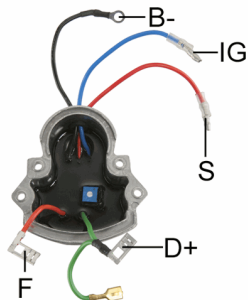

Replaces

MANDO :

3ER1071 42785

VALEO :

3ER1071 42785

Unit no.

MANDO

AR150A AR150AA AR150AC

VR-MD06

*Voltage Setting:14.5V

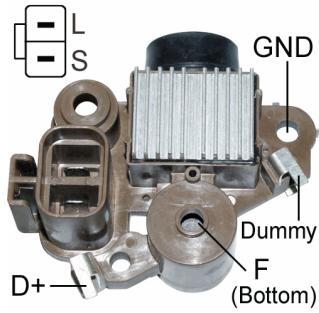

Replaces

HYUNDAI :
37370-22600

MANDO :
TA500-C09001

Unit no.

HYUNDAI
37300-22600
MANDO
AB180128

VR-MD06L

*Voltage Setting:14.2V

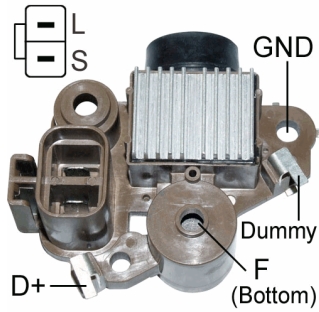

Replaces

VALEO :
M903

Unit no.

VALEO
TA000A48401 TA000A48402

VR-MD07

*S-L Terminals
*A-Circuit
*Active L Terminal
*Repair Circuit: VR-MD07S
*Voltage Set Point:14.4V

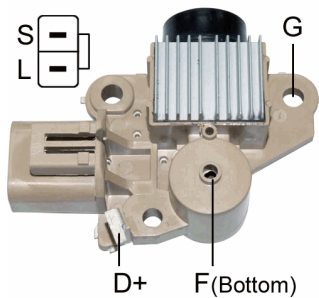

Replaces

VALEO :
231425

Unit no.

MANDO
AB170094

VR-MD08

*Voltage Set Point:14.4V

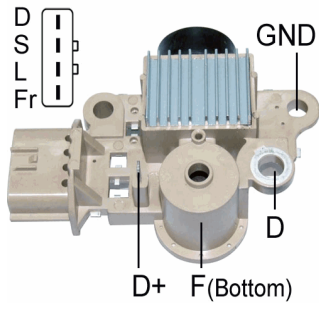

Replaces

HYUNDAI :
37370-38310

Unit no.

HYUNDAI
37300-39600
MANDO
AB112145

TB-M146

*Terminal Block

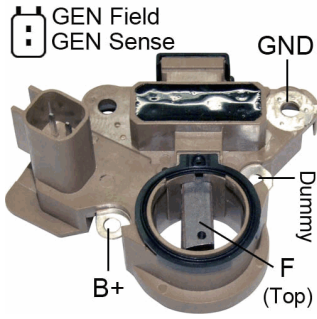

Unit no.

MITSUBISHI

A2TJ0481

A2TJ0481ZC

A002TJ0481ZC

A3TJ2581

VR-H2009

*A-Circuit
 *R-L Terminals
 *Voltage Set Point:14.7V

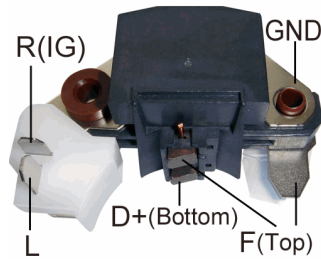

Replaces

BOSCH :

0-986-192-016

FORD :

E27Z-10316A

LUCAS :

21513103 UCJ200

MAGNETI MARELLI :

940038076

MAZDA :

8173-18-300 8173-24-520 N221-24-520

MITSUBISHI :

A866T00470 A866T00670 A866T01970 A866T02570 A866T02770 A866T03270

MITSUBISHI MOTORS :

MD607372 MD607570

Unit no.

MAZDA

1480-18-300	8173-18-300	8173-18-300B	8341-18-300	8356-18-300	D501-18-300
E301-18-300C	E301-18-300D	E302-18-300	E563-18-300A	FE01-18-300B	GE01-18-300
HE41-18-300	HE45-18-300	N221-18-300			

MITSUBISHI

A1T23377	A1T25191	A1T31371	A1T31699	A2T12371	A2T16471
A2T16471A	A2T16871	A2T16874	A2T23171	A2T23271	A2T23277
A2T23471	A2T23474	A2T23477	A2T24771	A2T25170	A2T25171
A2T26072	A2T26172	A2T31677	A2T40377	A2T41191	A2T41371
A2T41377	A2T46172	A3T21278	A3T21371	A3T32772	A3T32877
A3T34572	A3T34672	A3T34677	A4T25172	A4T25199	A4T30399
A5T15171	A5T15371	A5T15471	A5T15584	A5T20374	A5T20377
A5T20484	A5T20571	A5T21071	A5T21077	A5T21471	A5T22484
A5T23277	AQ2240K1	AQ2245G	AQ2245G1	AQ2245G7	AQ2245K1
AQ2250G1	AQ2250K1	AQ2250K7			

MITSUBISHI MOTORS

MD006187	MD007509	MD009052	MD009053	MD009054	MD018230
MD022572	MD022578	MD022579	MD025215	MD025677	MD025679
MD034130	MD034132	MD041700	MD060901	MD061818	MD062007
MD063781	MD064066	MD064067	MD064068	MD086046	MD086047
MD086048	MD104744				

VR-H2009-1

*24V
 *Voltage Set Point:28.3V

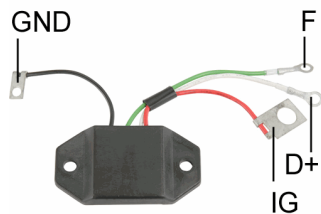

Replaces

MITSUBISHI :

3Y6693 R008T10471 R008T10472

VR-H2009-100

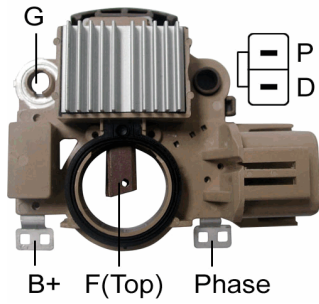

- * P-D Terminals
- * Short Circuit Protection
- ***Traditional test method will immediately damage P-D regulator. Avoid damage using Mobiletron VR-H2009-66TF test fixture.

Replaces

MAZDA :

GY01-18-W70

MITSUBISHI :

465 A866X46572

Unit no.

MAZDA

GY01-18-300E GY01-18-300R

MITSUBISHI

A3TB1081 A3TB1081A

VR-H2009-102

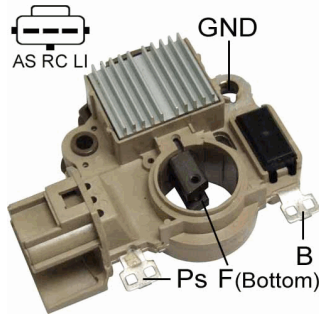

- *AS-RC-LI Terminals
- *Repair Circuit: VR-H2009-102S
- *Voltage Set Point:14.0V
- *Regulated Voltage Control(RVC)
- *Used on Ford Mondeo and Escape 2.0
- *Requires VR-RVC01 test adaptor for testing

Replaces

MITSUBISHI :

A866X50372

Unit no.

FORD

2S6T-10300DB 2S6U-10300GB

MITSUBISHI

A003TG5591ZC A5TA7792

VR-H2009-103

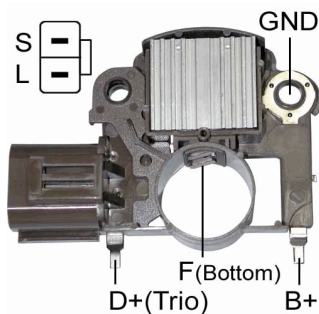

- *S-L Terminals
- *Repair Circuit:VR-H2009-11S
- *Voltage Set Point:14.6V
- *w/o Drive Choke

Replaces

MITSUBISHI :

145 A866X14570 A866X14572

Unit no.

MITSUBISHI

A005T03092 A005T03192 A5T00192

VR-H2009-105

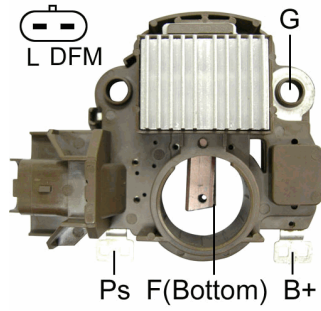

- * L-DFM Terminals
- * Soft Start
- * 3.5 sec LRC
- * Repair Circuit:VR-H2009-105S
- * Voltage Set Point:14.5V

Replaces

MITSUBISHI :
A866X49872

Unit no.

CITROEN

9638275880

MITSUBISHI

A5TA6291

A1TA3391

A1TA3392C

A5TA6291

A5TA6291A

A5TA6291C

A5TA6292

A5TA6292C

A5TA6292F

A005TA6291G

VR-H2009-105SE

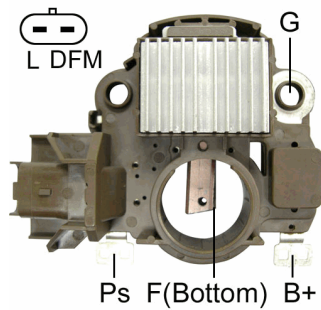

- * L-DFM Terminals
- * Soft Start
- * 2.5 sec LRC
- *Self Exciting
- * Voltage Set Point:14.5V

Replaces

MITSUBISHI :
239735

506

Unit no.

CITROEN

9640088080

MITSUBISHI

A5TA6391

A5TA6292F

A5TA6292G

A5TA6391A

A5TA6391B

A5TA6391C

A5TA6392C

A003TB2691G

VR-H2009-107

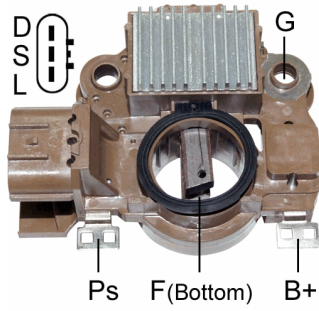

- * D-S-L Terminals
- * Voltage Set Point:14.4V

Replaces

MITSUBISHI :

235102 566

SUBARU :

23815-AA150 23815-AA140

Unit no.

MITSUBISHI

A3TG2391 A2TB6291

SUBARU

23700-AA430 23700-AA55A

VR-H2009-108

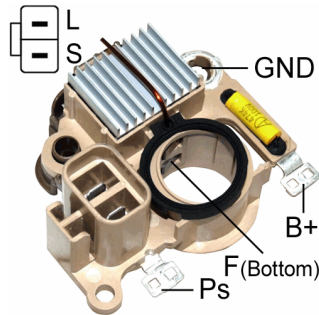

- *S-L Terminals
- *Soft Start
- *Short Circuit Protection
- *Repair Circuit:VR-H2009-115S
- *Voltage Set Point:14.5V

Unit no.

FORD

XF52-10300AC XF5Z-10346AA

MITSUBISHI

A3TA5691

NISSAN

23100-7B000

VR-H2009-109

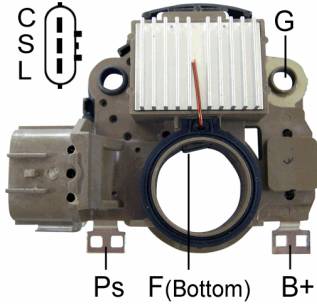

- *C-S-L Terminals
- *Voltage Set Point: 14.5V
- *Soft Start
- *Short Circuit Protection

Replaces

MITSUBISHI :

A3TB1891 A866X47272

SUBARU :

23815-AA160

Unit no.

MITSUBISHI

A2TB3091 A2TB5391 A3TB1891

SUBARU

23700-AA380 23700-AA420

VR-H2009-10A

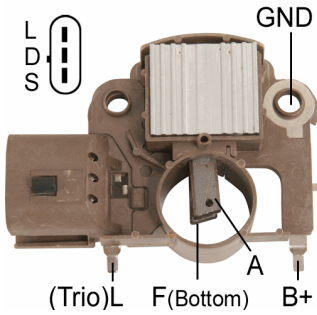

- *I-S(D)-A Terminals
- *Repair Circuit: VR-H2009-10AS
- *Voltage Set Point: 14.6V

Replaces

FORD :

E8PZ-10316B GRE793

MITSUBISHI :

A866X13970 A866X13971

Unit no.

FORD

E83F-10300AA E83F-10300AB E83F-10300BA E83Z-10346A E8DF-10300AB E8DZ-10346A

MITSUBISHI

A3T01596MA A3T01598MA A3T01598NA

VR-H2009-110

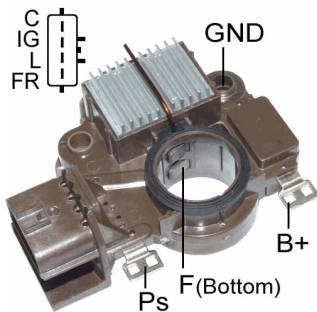

- *C-IG-L-FR Terminals
- *Soft Start
- *Short Circuit Protection
- *Voltage Set Point: 14.5V

Replaces

MITSUBISHI :

A866X44472 590

Unit no.

MITSUBISHI

A1TA1891 A1TA1891A A1TA1991 A1TA2491 A1TG0091 A5TG0991

VR-H2009-111

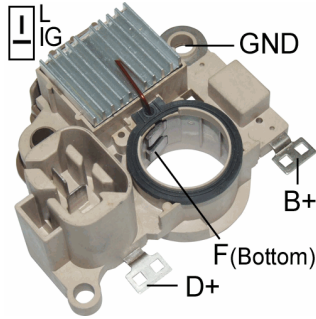

- *L-IG Terminals
- *w/ capacitor
- *Voltage Set Point:14.7V

Replaces

MITSUBISHI :
A866X35972

Unit no.

SUZUKI
31400-73G11

Used On

SUZUKI
Jemini 660CC

VR-H2009-112

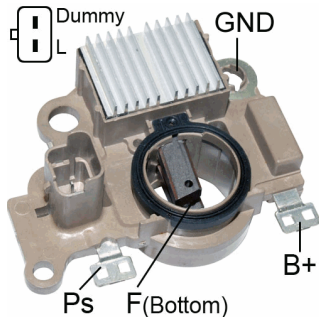

- * L-Dummy Terminals
- * L Terminal Drive Choke
- * Soft Start
- * 6 sec. LRC
- * Short Circuit Protection
- * Repair Circuit: VR-H2009-112S
- * Voltage Set Point:14.5V

Replaces

MITSUBISHI :
235547

Unit no.

MITSUBISHI
A2TB6481 A2TC0981 A2TC0982 A1TA2291 A1TA2293

Used On

RENAULT
Clio 2001-
Kangoo 2001-
Megane 1.6L 2002-

VR-H2009-113

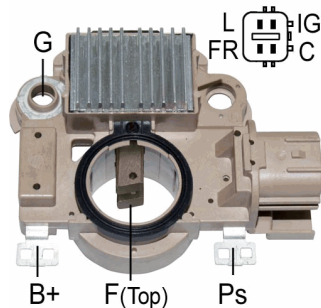

- *IG-C-L-FR Terminals
- *Inactive Lamp
- *Soft Start
- *4 sec LRC
- *Short Circuit Protection
- *Voltage Set Point:14.5V

Unit no.

MITSUBISHI
A2TC1391 A2TC1391ZC

Used On

HONDA		
Civic	1.6L	2006-2008
Civic	2.0L	2006-

VR-H2009-114

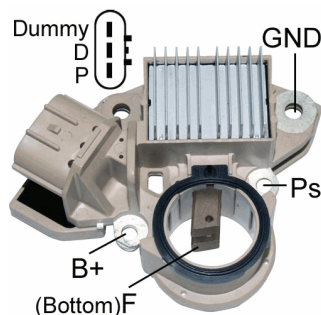

- *Inactive Lamp
- *W/Capacitor 2.2uF
- *Works with PCM
- **Traditional test method will immediately damage P-D regulator. Avoid damage using Mobiletron VR-H2009-66TF test fixture.

Replaces

MITSUBISHI :
A866X50572

Unit no.

MAZDA					
AJ51-18-300	AJ57-18-300A	AJ51-18-W70	LFB6-18-300	L3M6-18-300A	L3M6-18-300B
MITSUBISHI					
A3TJ1191	A2TJ0391	A3TJ0191	A3TJ0291		

Used On

MAZDA		
CX-7 2.3L		2007-2008
Van 2.5L		2012-

VR-H2009-115

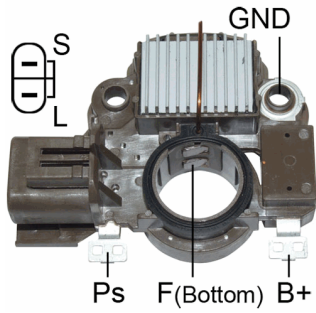

- * S-L Terminals
- * Inactive Lamp
- * Short Circuit Protection
- * S Open Lamp On
- * Voltage Set Point:14.5V

Replaces

MITSUBISHI :

350 626

Unit no.

MITSUBISHI

A2TA7691

Used On

SUBARU

Forester	2.5L	1998-
Impreza	1.8L	1997-
Impreza	2.2L	1997-1998

VR-H2009-118

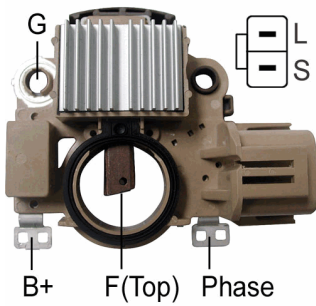

- *S-L Terminals
- *Short Circuit Protection
- *S Open Lamp On
- *Voltage Set Point:14.5V

Replaces

MITSUBISHI :

A866X36272

NISSAN :

23215-0M011

Unit no.

MITSUBISHI

A2T33593B

NISSAN

23100-0M010 23100-6T012

VR-H2009-119

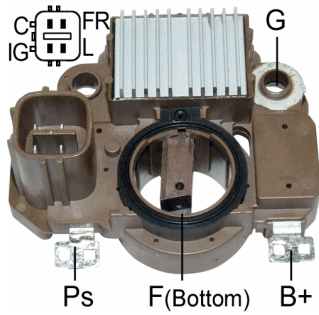

- *Inactive Lamp
- *C-FR-IG-L Terminals
- *Soft Start
- *4 sec. LRC
- *Short Circuit Protection
- *Voltage Set Point:14.5V

Unit no.

HONDA
31100-RSH-004
MITSUBISHI
A5TB1391

Used On

HONDA
Fit 1.5L

2007-2008

VR-H2009-11H

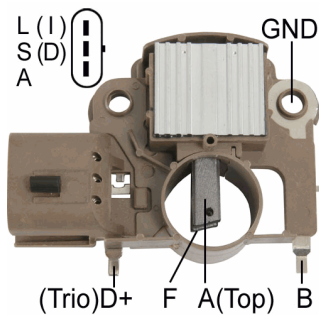

- *I-S(L/IG)-A Terminals
- *Repair Circuit:VR-H2009-11S
- *Voltage Set Point:14.6V

Replaces

FORD :
E8PZ-10313A E8PZ-10316A GRE792

MITSUBISHI :
A866X14072

MOTORCRAFT :
GRE317

Unit no.

FORD
E8SF-10300AA E8SZ-10346A

MITSUBISHI
A3T01496 A3TO1496MA

MOTORCRAFT
GLE-254

VR-H2009-12

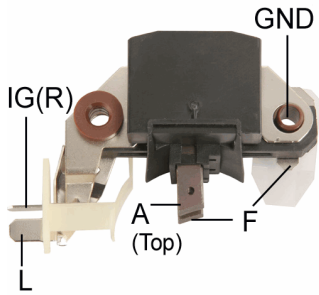

- *24V
- *R-L Terminals
- *Voltage Set Point:28.3V

Replaces

MITSUBISHI :
A866T06670

MITSUBISHI MOTORS :
ME700571

Unit no.

MITSUBISHI			
A5T70178	A5T70183	A5T70283	A5T70383
MITSUBISHI MOTORS			
ME007578	ME017560	ME017561	ME049165

VR-H2009-120

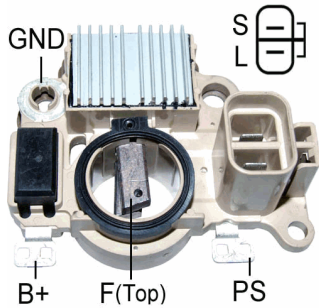

- *A-Circuit
- *Inactive Lamp
- *Short Circuit Protection
- *S Open Lamp On
- *Voltage Set Point:14.5V

Replaces

MITSUBISHI :
A866X39183

Unit no.

MITSUBISHI
A7TA3377
NISSAN
23100-FU410

VR-H2009-121

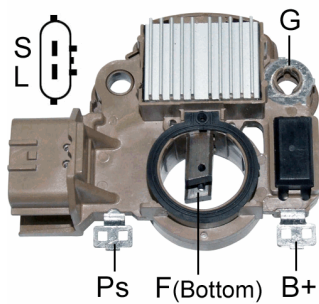

- *Soft Start
- *Short Circuit Protection
- *Voltage Set Point: 14.4V

Unit no.

NISSAN
23100-2Y005

VR-H2009-122

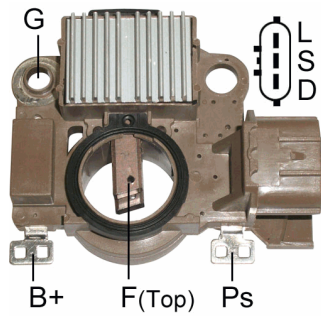

- *Soft Start
- *5 sec. LRC
- *Short Circuit Protection
- *Voltage Set Point: 14.4V

Replaces

MITSUBISHI :
A866X56672

Unit no.

MITSUBISHI
A3TG2681AE A2TG1581 A2TG1581AC
NISSAN
23100-ZW40B 23100-EB31A

VR-H2009-123

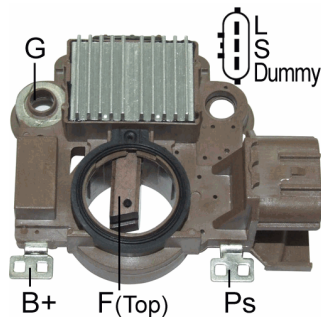

- *Short Circuit Protection
- *Voltage Set Point: 14.5V

Unit no.

MITSUBISHI
A2TG-1081ZT
NISSAN
23100-EB71A

VR-H2009-125B

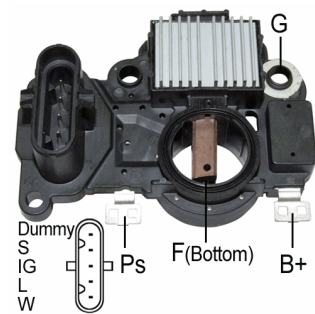

- *24V
- *Voltage Set Point:28.3V

Replaces

MITSUBISHI :
576

Unit no.

MITSUBISHI
A004TA8191 A4TA8191

VR-H2009-129

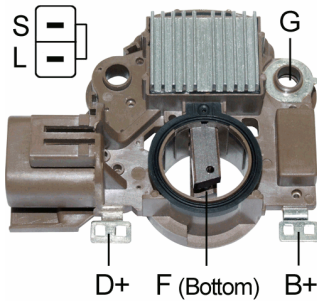

*S-L Terminals
*Voltage Set Point: 14.5V

Replaces

MAZDA :

B307-18-W70 B3C7-18-W70 B64J-18-W70 B64J-18-W70A JE48-18-W70

MITSUBISHI :

A866X38072 A866X24072 A866X20572 A866X24082 A866X25372 A866X27472

Unit no.

MITSUBISHI

A3TA2391A A3TA2391

MITSUBISHI MOTORS

MD313384 MD318460 MD354804

VR-H2009-130

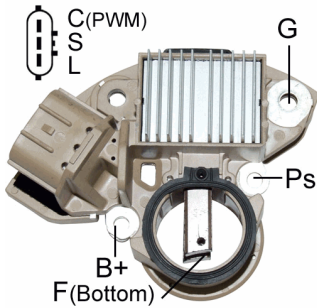

*Soft Start
*5 sec LRC
*W/Capacitor 2.2uF
*Short Circuit Protection
*Voltage Set Point:14.5V

Replaces

MITSUBISHI :

A866X68272 A866X54779 A866X54762

Unit no.

MITSUBISHI

A3TJ0691 A3TJ0781 A2TJ0581

NISSAN

23100-1FC1A 23100-EB315 23100-EG010

Used On

INFINITI

M35 3.5L 2006-2008

NISSAN

Navara 2.5 dCi 2005-

Navara 2.5 dCi 4WD 2006-

Pathfinder 2.5 2006-2007

Pathfinder 2.5 4WD 2005-2006

VR-H2009-132B

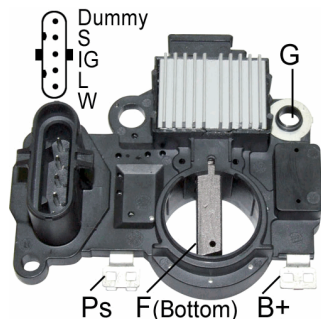

- *24V
- *S Open Lamp On
- *Voltage Set Point: 28.3V

Replaces

MITSUBISHI :
553

Unit no.

MITSUBISHI
A4TR5894ZT A4TR5591ZT

VR-H2009-132BA

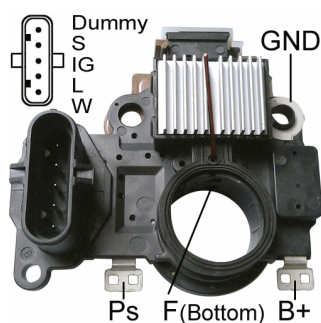

- *24V
- *S Open Lamp On
- *Voltage Set Point: 28.3V
- *w/plastic cover, insulated plate, protect cover for welding

Replaces

MITSUBISHI :
553

Unit no.

MITSUBISHI
A4TR5894ZT

VR-H2009-135B

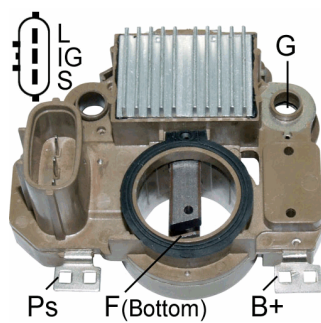

- *24V
- *L-IG-S Terminals
- *Voltage Set Point:28.3V

Unit no.

MITSUBISHI
A4TA0591 A4TA0592 A4TA0594 A4TA8291 A4TA8292

VR-H2009-139

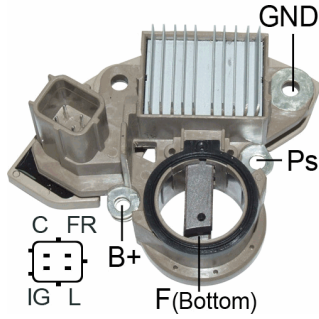

- *C-FR-IG-L Terminals
- *Soft Start
- *7 sec. LRC
- *W/Capacitor 2.2uF
- *Voltage Set Point:14.5V

Replaces

MITSUBISHI :
605

Unit no.

HONDA
31100-RB0-004 31100-RB0-0041 31100-RB0A-0243
MITSUBISHI
A5TJ0091

Used On

HONDA
Fit 4 Cyl. 1.5L 2009-2012

VR-H2009-13H

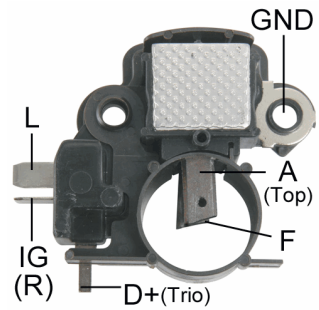

- *R-L Terminals
- *Repair Circuit:VR-H2009-4S
- *Voltage Set Point:14.6V

Replaces

MITSUBISHI :
A866X06772 A866X14172
SUBARU :
23615-KA020 49575-6404

Unit no.

MITSUBISHI
A1T02952 A7T30371 A7T30492 A7T30674 A7T30692
SUBARU
23700-KA130 23700-KA140 23700-KA170 23700-KA190 42990-6400 42990-6500

VR-H2009-140

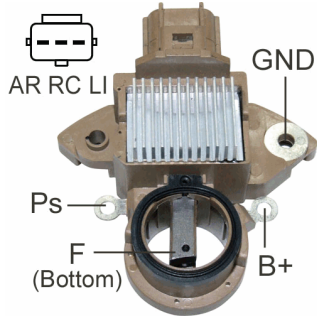

- *Voltage Set Point: 14.0V
- *Regulated Voltage Control(RVC)
- *Requires VR-RVC01 test adaptor for testing

Replaces

MITSUBISHI :
622

Unit no.

FORD
8S4T-10300AA 8S4Z-10346A 8A4T-10300AC 8A4Z-10346A
MITSUBISHI
A3TX0091 A2TX0191

Used On

FORD

Focus 2.0L	2008-2010
Focus 2.3L	2008-2010
Escape 2.5L	2009-

MAZDA

Tribute 2.5L	2009-
--------------	-------

VR-H2009-144

Dummy FR

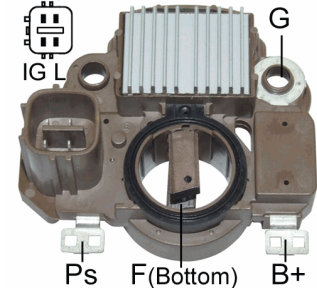

- *Soft Start
- *5 sec. LRC
- *Short Circuit Protection
- *Voltage Set Point: 14.5V

Replaces

HONDA :
31150-REA-Z01

Unit no.

HONDA
31100-REA-Z01 AHGA58
MITSUBISHI
A5TB0291ZD

Used On

HONDA

Fit	2004-2007
Jazz	2004-2007

VR-H2009-145

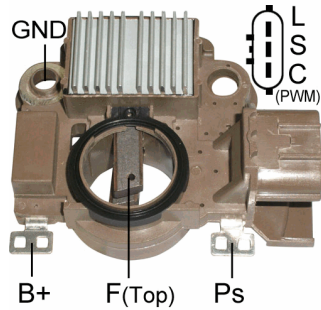

- *C-S-L Terminals
- *Voltage Set Point: 14.5V
- *Soft Start
- *5 sec. LRC
- *Short Circuit Protection
- *Regulated Voltage Control (RVC)

Replaces

MITSUBISHI :

A866X54472 547 544

Unit no.

MITSUBISHI

A3TG2681ZE A3TG5381RL A003TG5381RL

NISSAN

23100-EB310

Used On

NISSAN

Navara 2.5 dCi

VR-H2009-147

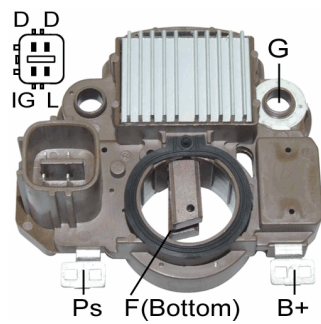

- *Soft Start
- *8 sec. LRC
- *Short Circuit Protection
- *Voltage Set Point: 14.6V

Replaces

SUZUKI :

32500-61J00

Unit no.

SUZUKI

31400-61J00

VR-H2009-148

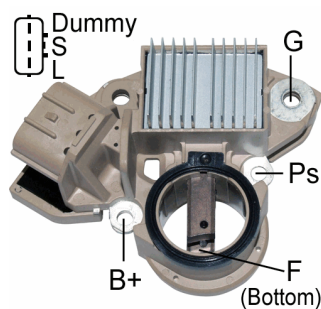

- *Soft Start
- *5 sec LRC
- *W/Capacitor 0.5uF
- *Short Circuit Protection
- *Voltage Set Point: 14.5V

Replaces

MITSUBISHI :

564

Unit no.

MITSUBISHI

A2TJ0281 A2TJ0281ZC A2TJ0291 A2TJ0291ZC

NISSAN

23100-EM01A

VR-H2009-14N

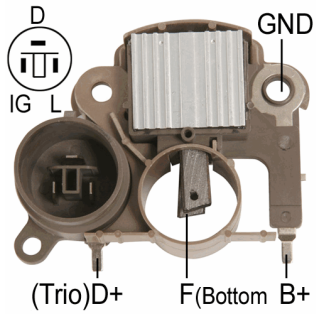

*D-IG-L Terminals
 *Repair Circuit:VR-H2009-14NS
 *Voltage Set Point:14.6V
 *w/o Drive Choke

Replaces

MITSUBISHI :
 A866X11870
SUZUKI :
 32500-60A10

Unit no.

MITSUBISHI
 A1T03191 A1T03195
 SUZUKI
 31400-60A20

VR-H2009-15

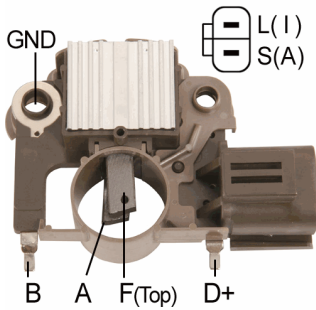

*I-A Terminals
 *Repair Circuit:VR-H2009-15S
 *Voltage Set Point:14.5V

Replaces

FORD :
 E9PZ10316AA
MITSUBISHI :
 A866X13272 A866X15170 A866X17470 A866X21472 A866X19172 A866X20782
 A866X21472 A866X21482
NISSAN :
 23215-35F10 23215-64J11 23215-64J12

Unit no.

FORD
 E9DF-10300BB E9PZ-10316A
 MITSUBISHI
 A2T02394 A2T05192 A2T13894 A2T14694 A2T18792 A2T48195
 A3T00491 A3T12691
 MOTORCRAFT
 GLE-261 GRE-796
 NISSAN
 23100-12C10 23100-15P11 23100-31P10 23100-35F10 23100-65E10

VR-H2009-151B

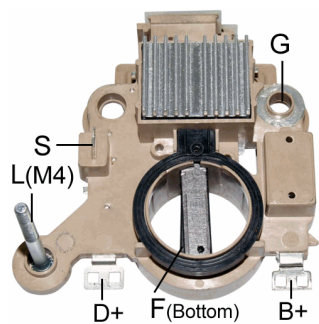

*24V
*Voltage Set Point: 28.7V

Unit no.

MITSUBISHI			
A3TR5191	A4TR5188	A4TR5191ZT	A4TR5191
SCANIA			
1516176	1525447		

VR-H2009-152

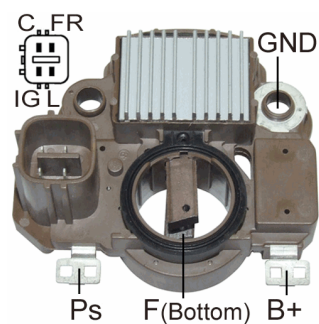

*C-FR-IG-L Terminals
*Soft Start
*Short Circuit Protection
*Voltage Set Point: 14.5V

Replaces

MITSUBISHI :	
A866X31782	438

Unit no.

HONDA		
31100-PEJ-004	AHGA35	
MITSUBISHI		
A5TA4591	A5TA0991	A5TA3591

Used On

HONDA		
Civic 1.6L		1999-2000
Logo 1.3L		1999-2002

VR-H2009-153

*Voltage Set Point: 14.3V

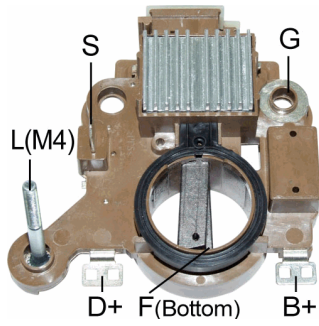

Unit no.

MITSUBISHI

A3TR0091

A3TR0093

A3TR0094

A3TR0091ZT

A3TR0093ZT

A3TR0094ZT

Used On

VOLVO

Penta D1-13

Penta D1-20

Penta D1-30

Penta D2-40

Penta D2-55

Penta D2-75

Penta D4-250

Penta D6-310

D6-435

VR-H2009-154B

*24V

*Voltage Set Point: 28.5V

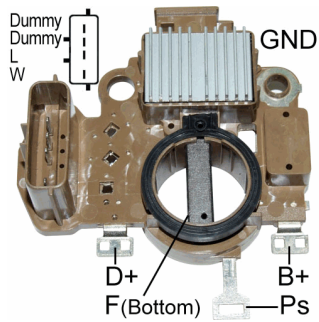

Unit no.

MITSUBISHI

A4TR5091ZT

A4TR5091

RENAULT

5001866377

5010480765

VR-H2009-159

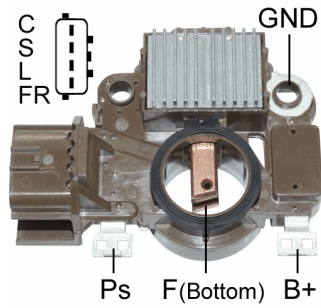

*Soft Start
 *S Open Lamp On
 *Voltage Set Point: 14.5V

Replaces

MITSUBISHI :

557 428

Unit no.

MITSUBISHI

A3TG3181 A3TB5291

Used On

MITSUBISHI

Lancer 2.0L

2008-2009

Outlander 2.4L

2008-2009

VR-H2009-16

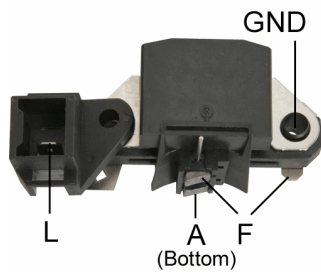

*L Terminal
 *Voltage Set Point:14.7V

Replaces

DELCO REMY (LUCAS) :

21513127

MITSUBISHI :

A866T03870 A866T05670 A866T13370

Unit no.

MITSUBISHI

A2T26391 A2T27091 A3T03291 A3T03292 A3T03298

VR-H2009-161

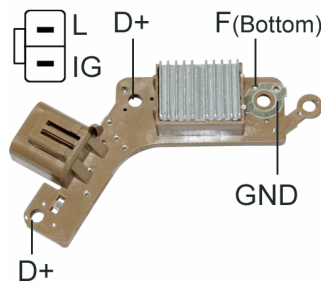

*Voltage Set Point: 14.5V

Replaces

MITSUBISHI :

A866X28672

Unit no.

MITSUBISHI

A4TU0088

VR-H2009-168

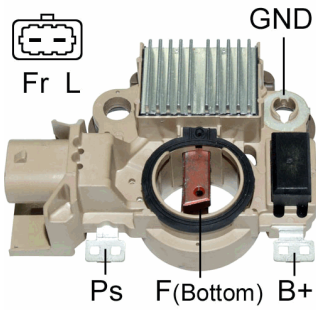

- *Soft Start
- *5 sec LRC
- *Short Circuit Protection
- *Voltage Set Point:14.5V

Unit no.

MITSUBISHI
A3TG1491

VR-H2009-169

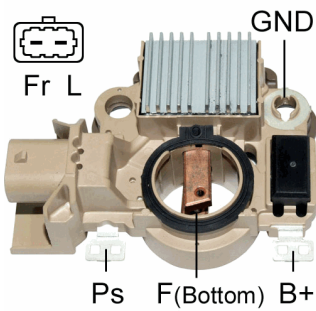

- * Fr-L Terminals
- * Soft Start
- * 2.5 sec LRC
- *Self Exciting
- * Voltage Set Point:14.5V

Unit no.

MITSUBISHI
A003TG1581

Used On

PONTIAC
GTO 8 Cyl. 6.0L

2005-2006

VR-H2009-17

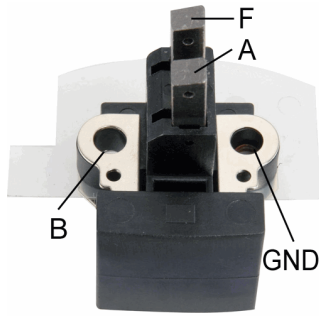

*24V
*Voltage Set Point:28.3V

Replaces

MITSUBISHI :
A866T01070 A866X01070

MITSUBISHI MOTORS :
ME700091

Unit no.

MITSUBISHI

A2T61571	A2T61871	A2T61971	A2T70571	A2T70671	A2T70771
A2T70772	A2T70774	A2T71183	A2T71478	A2T71483	A2T71578
A2T71583	A2T71683	A2T71978	A2T71983	A3T68071	A3T76071
A3T76072	A3T76073	A3T76075	A3T77071	A4T56771	A4T56772
A4T56773	A4T56871	A4T57371	A4T57471	A4T57472	A4T65571
A4T65671					

MITSUBISHI MOTORS

ME007396	ME007397	ME007533	ME007540	ME007550	ME017507
ME017509	ME017516	ME017550	ME017552	ME017553	ME037370
ME037371	ME037372	ME037481	ME037482	ME037593	ME067611
ME067614	ME067617	ME067630	ME067631	ME067632	ME067635
ME067640	ME067641	ME067642	ME067644		

VR-H2009-170

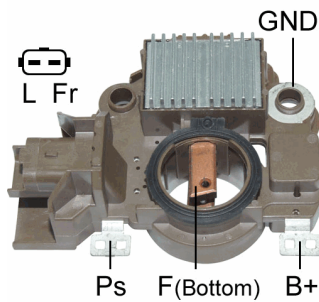

* L-Fr Terminals
* Soft Start
* 3.5 sec LRC
* Short Circuit Protection
* Self Exciting
* Voltage Set Point:14.5V

Unit no.

CITROEN
9642124980
MITSUBISHI
A003TB2691K A3TB2691K A3TB2691

Used On

CITROEN

Berlingo LCV 1400	2008-2012
Berlingo LCV 1600 16V	2008-2012
C4 1400 16V	2004-2010
C4 1600 16V	2004-2010
C5 1800 16V	2001-2010
C5 2000 16V	2001-2004

PEUGEOT

207 1400 16V	2008-2012
407 2200 16V	2004-2010
807 2200 16V	2002-2010
807 2200 16V	2002-2010

VR-H2009-172

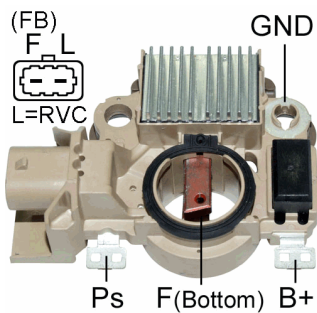

- *Soft Start
- *4 sec. LRC
- *Short Circuit Protection
- *Voltage Set Point: 13.8V

Unit no.
 MITSUBISHI
 A3TG4091 A3TG4191

Used On

POCLAIN	
G8 V6 3.6L	2008-2009
PONTIAC	
G8 V8 6.0L	2009-
G8 V8 6.2L	2009-

VR-H2009-175

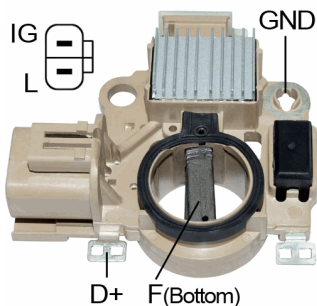

- *Voltage Set Point: 14.5V

Unit no.
 MITSUBISHI
 ME192608

VR-H2009-176

- *Soft Start
- *7 sec LRC
- *Short Circuit Protection
- *Voltage Set Point: 14.5V

Unit no.
 MITSUBISHI
 A2TX1181
 NISSAN
 23100-1BN1A

VR-H2009-18

*R-L Terminals
*Voltage Set Point:14.7V

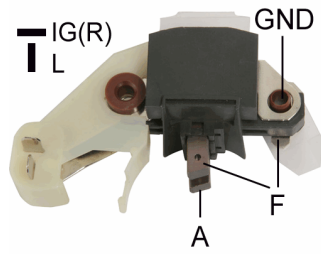

Replaces

MAZDA :
SE21-24-520

MITSUBISHI :
A866T03070 A866T03470 A866T18270

MITSUBISHI MOTORS :
MD607619

Unit no.

MAZDA
4813-18-300

MITSUBISHI
A1T32084 A2T15384 A2T43583 A5T22484

MITSUBISHI MOTORS
MD013740 MD072582 MD087246

VR-H2009-180

*Soft Start
*5 sec LRC
*Short Circuit Protection
*Voltage Set Point:14.5V

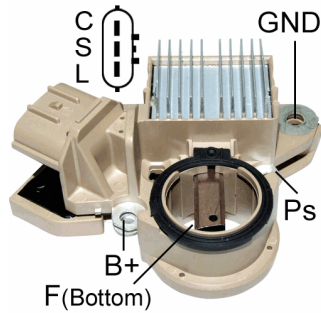

Unit no.

MITSUBISHI
A3TJ3591 A003TJ3591

NISSAN
23700-AA620

Used On

SUBARU

Legacy 3.6L	2010-2011
Outback 3.6L	2010-2011
Tribeca 3.6L	2010-2011

VR-H2009-19

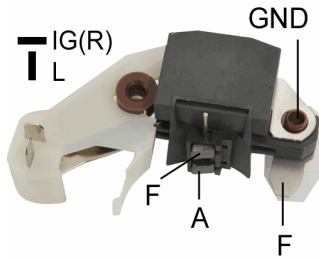

*24V
 *R-L Terminals
 *Voltage Set Point:28.3V

Replaces

MAZDA :
 SE17-24-520
MITSUBISHI :
 A866T03570

Unit no.
 MITSUBISHI
 A6T65199

VR-H2009-20

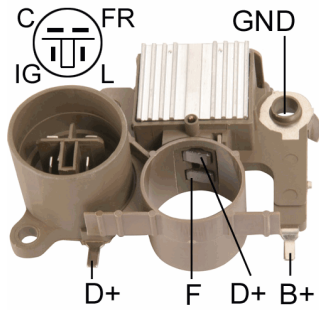

*C-FR-IG-L Terminals
 *Repair Circuit:VR-H2009-20S
 *Voltage Set Point:14.6V

Replaces

MITSUBISHI :
 A866T38570 A866X13670 A866X22072

Unit no.
 HONDA
 31100-AHG-A03
MITSUBISHI
 A1T02291 A1T02292 A1T04892 A5T04072 A5T04092 A5T04292
 A5T06291

VR-H2009-21

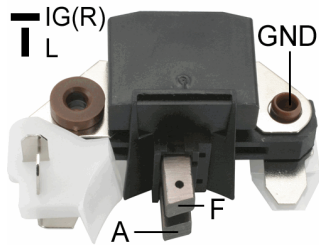

*24V
 *R-L Terminals
 *Voltage Set Point:28.3V

Replaces

MITSUBISHI :
 A866T02070

Unit no.
 MITSUBISHI
 40Q A641 T46070

VR-H2009-22

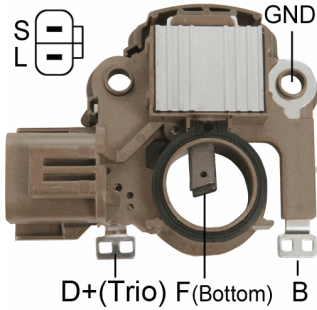

*S-L Terminals
 *Repair Circuit:VR-H2009-43S
 *Voltage Set Point:14.5V

Replaces

MAZDA :

B64J-18-W70 JE48-18-W70

MITSUBISHI :

A866X27772 A866X22772 A866X20472 A866X20972

Unit no.

FORD

FS1118300A

MAZDA

B366-18-300 B3C7-18-300 B61P-18-300 B64J-18-300B B665-18-300 FELC-18-300

FS05-18-300 JE48-18-300 K801-18-300 N3A1-18-300 RFG7-18-300

MITSUBISHI

A2T33191 A2T33891 A2T33991 A2T35177 A2T36578 A2T38977

A3T07592 A3T08491 A3T08591 A5T03391 A5T03677 A5T03777

VR-H2009-23

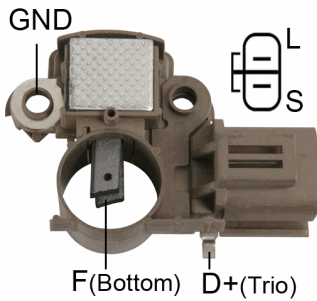

*S-L Terminals
 *Repair Circuit:VR-H2009-7S
 *Voltage Set Point:14.6V

Replaces

MITSUBISHI :

A866X08472

NISSAN :

23215-58S10

Unit no.

MITSUBISHI

A5R41592 A5T41592 A5T41592B

NISSAN

23100-53A10 23100-53A11

VR-H2009-24

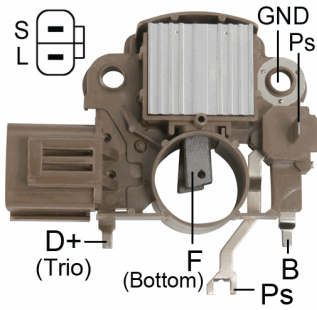

*S-L Terminals
 *Repair Circuit:VR-H2009-10S
 *Voltage Set Point:14.5V

Replaces

FORD :

F0BZ-10316A

MITSUBISHI :

A866X17170 A866X17172

Unit no.

FORD

F0CZ-10346B FOBZ-10346A

MAZDA

B113-18-300B BP02-18-300A

MITSUBISHI

A5T00877 A5T00972 A5T02777

VR-H2009-25

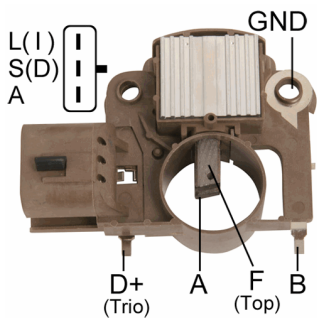

*I-S(D)-A Terminals
 *Repair Circuit:VR-H2009-10AS
 *Voltage Set Point:14.5V

Replaces

FORD :

E9PZ-10316B

MITSUBISHI :

A866X15472

MOTORCRAFT :

GRE797

Unit no.

FORD

E9SF-10300DA E9SZ-10346A

MITSUBISHI

A4T00796

MOTORCRAFT

GLE-265

VR-H2009-26

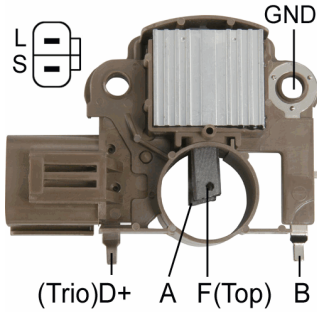

*S-L Terminals
 *Repair Circuit:VR-H2009-10S
 *Voltage Set Point:14.5V

Replaces

FORD :

F02Z-10316A GRE799

MAZDA :

F285-18-W70

MITSUBISHI :

A866T17972	A866X00179	A866X17972	F28518W70A	A866X09971	A866X09972
A866X09982	A866X14570	A866X14572	A866X17972	A866X17982	

MOTORCRAFT :

GRE799

NISSAN :

F285-18-W70A 23215-77A10

Unit no.

MITSUBISHI

A002T19991	A002T34477	A003T06791	A2R20191	A2T17574	A2T19991
A2T20091	A2T20191	A2T20191ZC	A2T21191	A2T34477	A3T08891
A5R01577	A5T01577	A5T01977	B36618300G	F28518300C	N39018300A

VR-H2009-27

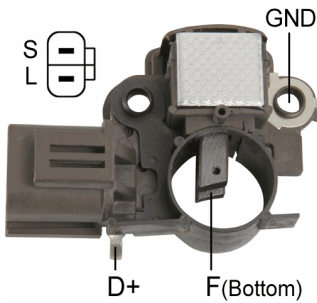

*S-L Terminals
 *Repair Circuit:VR-H2009-7S
 *Voltage Set Point:14.6V

Replaces

MITSUBISHI :

A866X06470 A866X06471

NISSAN :

23133-08E15 23313-08515

Unit no.

MITSUBISHI

A2T47794

NISSAN

23100-51S10

VR-H2009-28

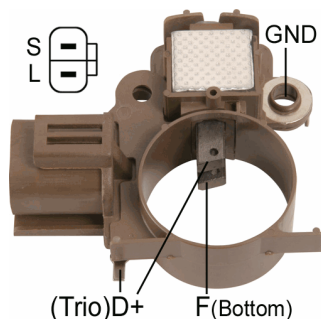

*S-L Terminals
 *Repair Circuit:VR-H2009-5S
 *Voltage Set Point:14.6V

Replaces

MITSUBISHI :

A866T09170 A866X09170 A866X10271 MD611481 MD611668 A866X09171

MITSUBISHI MOTORS :

MD611481

Unit no.

MITSUBISHI

A2T01384 A2T01483 A2T01583 A2T01683 A2T01783 A2T02084

A2T06384 A2T09884 A2T10083 A2T14376 A2T14876 A2T27883

A2T49377

MITSUBISHI MOTORS

MD102864 MD102865 MD103372 MD103373 MD103564 MD106319

MD106320 MD106332 MD112318 MD124233 MD124234 MD127087

MD132130 MD611481

VR-H2009-3

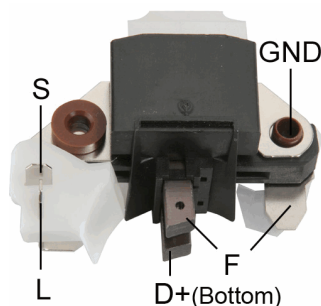

*S-L Terminals
 *Voltage Set Point:14.7V

Replaces

LUCAS :

21511095 21511116 UCJ207

MAGNETI MARELLI :

940038075

MAZDA :

8574-24-520

MITSUBISHI :

A866T00870 A866T02970

NISSAN :

23215-P3017 23215-W7110

Unit no.

MAZDA

8574-18-300

MITSUBISHI

A1T22971 A1T25083 A2T24971 A2T40971 A3R40672 A3T21677

A3T33772 A3T40672 A5T20972 A5T21871

NISSAN

23100-01B10 23100-01B15 23100-01F10 23100-04M10 23100-10B10 23100-B9810

23100-D0211 23100-H7711 23100-P3017 23100-R9011 23100-W5811

VR-H2009-30

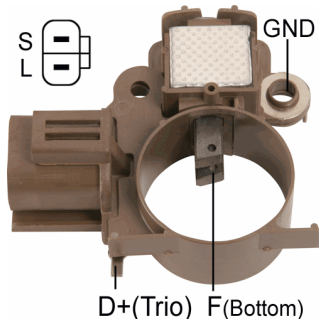

*S-L Terminals
*Voltage Set Point:14.4V

Replaces

MITSUBISHI :
A866X12682

MITSUBISHI MOTORS :
MD160671

Unit no.

MITSUBISHI

A3T01877

A3T01877B

A3T04177

A3T04178

A3T05676

VR-H2009-31

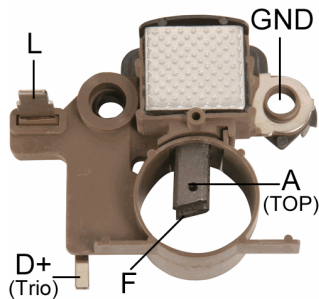

*L Terminal Only
*Repair Circuit:VR-H2009-5S
*Voltage Set Point:14.6V

Replaces

MITSUBISHI :
A866X07470

Unit no.

MITSUBISHI

A5T31772

VR-H2009-32

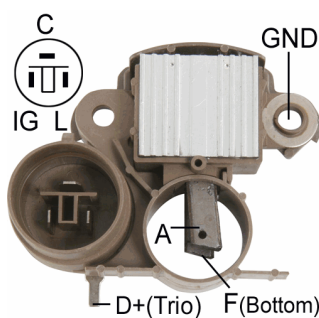

*C-IG-L Terminals
*Repair Circuit:VR-H2009-32S
*Voltage Set Point:14.6V

Replaces

HONDA :
31150-PE0-9270

MITSUBISHI :
A866X08270 A866X08271

Unit no.

HONDA

31100-PE0-906

31100-PE0-9270

MITSUBISHI

A1T01691

VR-H2009-33

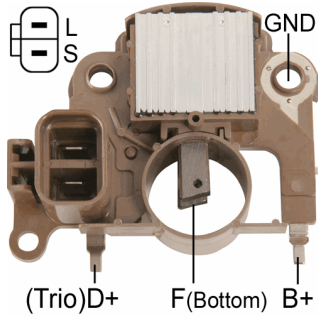

*S-L Terminals
 *Repair Circuit:VR-H2009-10S
 *Voltage Set Point:14.5V

Replaces

MAZDA :

JE15-18-W70A

MITSUBISHI :

A866X17072 A866X21072

Unit no.

FORD

F2JY-10346A

MAZDA

JE15-18-300A JE27-18-300 JE28-18-300 JF07-18-300

MITSUBISHI

A2T13977 A2T18177 A2T18277 A2T18874 A2T19677 A2T19877

A2T32899 A5T00777

MITSUBISHI MOTORS

MD150657

VR-H2009-34

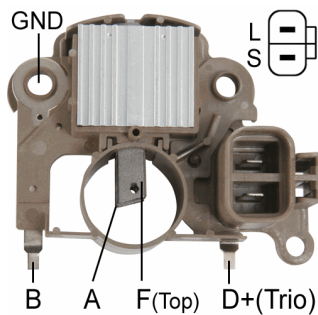

*S-L Terminals
 *Repair Circuit:VR-H2009-10AS
 *Voltage Set Point:14.5V

Replaces

MITSUBISHI :

A866X15770

Unit no.

MITSUBISHI

A1T03391 A1T03791

SUBARU

23700-KA240 23700-KA360

VR-H2009-35

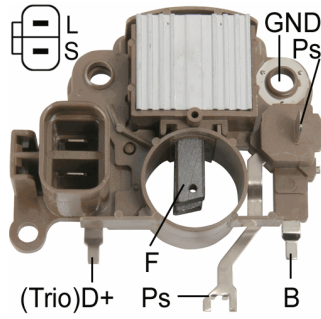

*S-L Terminals
 *Repair Circuit:VR-H2009-10S
 *Voltage Set Point:14.5V

Replaces

MITSUBISHI :
 A866X18972

Unit no.

MAZDA
 F2G8-18-300
 MITSUBISHI
 A5T02377

VR-H2009-37

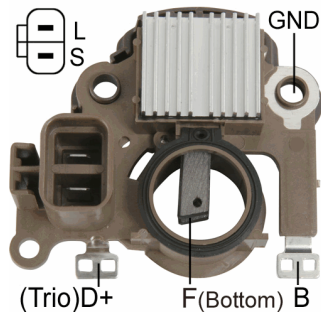

*S-L Terminals
 *S Open Lamp ON
 *Repair Circuit:VR-H2009-43S
 *Voltage Set Point:14.5V

Replaces

MITSUBISHI :
 A866X23172

Unit no.

MITSUBISHI
 A2T38391 A4T02591

VR-H2009-38

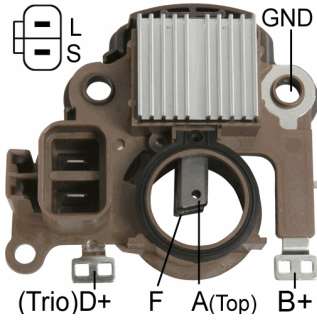

*S-L Terminals
 *S Open Lamp OFF
 *Repair Circuit:VR-H2009-38S
 *Voltage Set Point:14.6V

Replaces

MITSUBISHI :

A860X25472 A866X22272 A866X23182 A866X39772

MITSUBISHI MOTORS :

MD618569

Unit no.

FORD

F3XA-10300AC

MITSUBISHI

A2T34892 A2T34991 A2T34992 A2T35091 A2T35092 A2T36391

A2T36392 A2T38291 A2T38391 A2T38491 A2T38891 A2T38892

A2T39992 A3T11591 A3T12991 A3T13091 A3T13191 A3T13291

A3TA0791

MITSUBISHI MOTORS

MD175810 MD175811 MD177244 MD184278 MD184279 MD184280

MD184281 MD189658 MD189659 MD190812 MD190819 MD191402

MD191578 MD194466 MD196857 MD196858 MD198648 MD198649

NISSAN

23100-OB00

VR-H2009-40

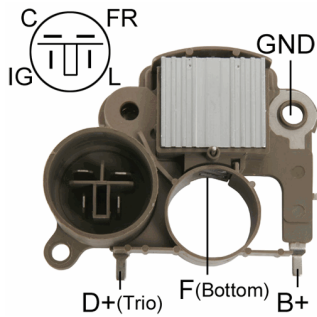

*C-FR-IG-L
 *Repair Circuit: VR-H2009-40S
 *Voltage Set Point:14.6V

Unit no.

HONDA

31100-008-014

MITSUBISHI

A5T04092

VR-H2009-41

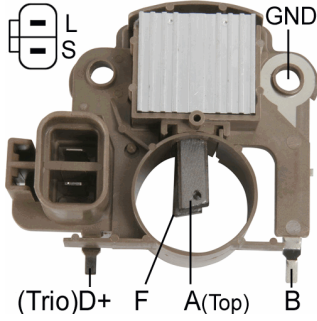

*S-L Terminals
 *Repair Circuit:VR-H2009-11S
 *Voltage Set Point:14.6V

Replaces

MITSUBISHI :
 A866X11772 A866X19072
MITSUBISHI MOTORS :
 MD611743

Unit no.

MITSUBISHI
 A4T01493 A4T01793 A4T01893 A4T02991 A4T03091 A4T03191

VR-H2009-43

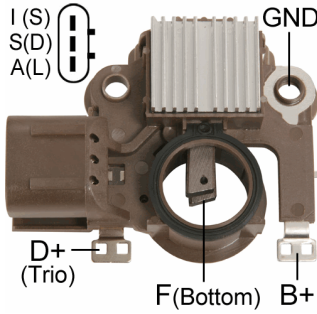

*I-S(D)-A Terminals
 *Repair Circuit:VR-H2009-43S
 *Voltage Set Point:14.5V

Replaces

MITSUBISHI :
 A866X24272
Unit no.
 FORD
 F3DZ-10346A F3LU-10300BC
 MITSUBISHI
 A6T41491 A6T41591

VR-H2009-44

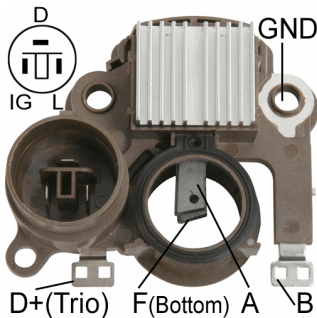

*D-IG-L Terminals
 *Repair Circuit:VR-H2009-44S
 *Voltage Set Point:14.7V

Replaces

MITSUBISHI :
 A866X23772
Unit no.
 MITSUBISHI
 A5T07091ZC A5T07092ZC
 SUZUKI
 31400-50G10 31400-60ACI 31400-63BD2

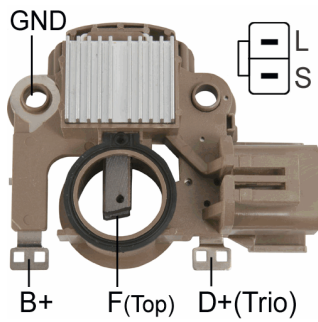
VR-H2009-45

*S-L Terminals
 *Repair Circuit:VR-H2009-45S
 *Lamp Short Circuit Protection
 *Voltage Set Point:14.5V

Replaces**MITSUBISHI :**

A866X22472 A866X23072

NISSAN :

23215-64J13

Unit no.

MITSUBISHI

A2T33593 A7T02874

NISSAN

23100-OP515

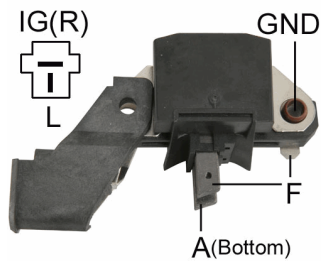
VR-H2009-46

*R-L Terminals
 *Voltage Set Point:14.7V

Replaces**MITSUBISHI :**

A866T08570

MITSUBISHI MOTORS :

ME700556

Unit no.

MITSUBISHI

A2T32583

MITSUBISHI MOTORS

ME017588

VR-H2009-47

*24V
 *R-L Terminals
 *Voltage Set Point:28.3V

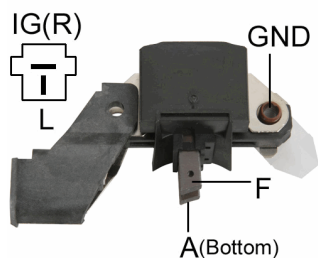

Replaces

MITSUBISHI :
 A866T06870

MITSUBISHI MOTORS :
 ME700635

Unit no.

MITSUBISHI

A2T32583	A2T72286	A4T57789	A4T57886	A4T65988	A6T75186
A6T75286					

MITSUBISHI MOTORS

ME017563	ME017588	ME037640	ME037641	ME037644	ME037989
ME067529					

VR-H2009-48

*R-L Terminals
 *For Fuso Truck
 *Voltage Set Point:14.7V

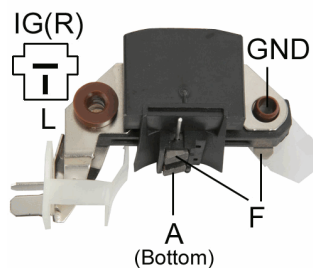

Replaces

MITSUBISHI :
 A866T06570

Unit no.

MITSUBISHI

A5T22578	A5T22583
----------	----------

MITSUBISHI MOTORS

ME001570	ME007577
----------	----------

VR-H2009-49

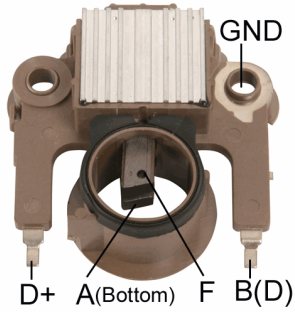

*Repair Circuit:VR-H2009-49S
 *For 23mm OD slip ring
 *Voltage Set Point:14.6V

Replaces

MITSUBISHI :
 A866X23200

Unit no.

MITSUBISHI

A2T13391C	A2T14591	A2T14592	A2T17491	A2T28792	A2T32692
A2T34591	A2T37091A	A2T37691	A2T81891	A2TA2292	A2TA2392
A2TA2492	A2TA2591	A4T00991	A4T00991C	A4T00991D	A4T03392
A4T03492					

VR-H2009-4A

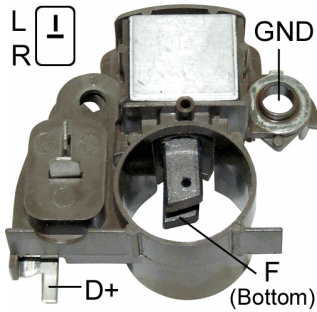

*Original part number is VR-MD02
 *For Use on Kia Pride 45A Alternator

Replaces

MAZDA :

E356-18-W70	E358-18-W70	FE65-24-520	FE79-24-520
-------------	-------------	-------------	-------------

MITSUBISHI :

A866T05272	A866X04870	A866X04871	A866X04872	A866X05470	A866X05471
A866X05472	A866X06072	A866X08672	A866X08672	A866X11682	

MITSUBISHI MOTORS :

MD611032	MD611146	MD618207	MM502532
----------	----------	----------	----------

Unit no.

KIA

02131-9021	OK72A-18300
------------	-------------

Used On

KIA

Pride	1.3L	1995-
-------	------	-------

VR-H2009-4H

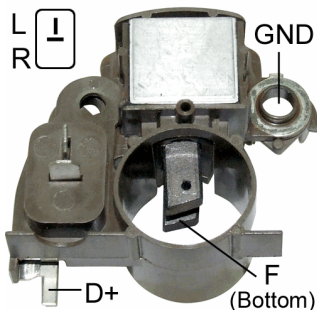

*R-L Terminals
 *Repair Circuit:VR-H2009-4S
 *Voltage Set Point:14.7V

Replaces

FORD :

E8GY-10316 E8JY-10316

HYUNDAI :

37370-21200

MAGNETI MARELLI :

940038085

MAZDA :

E356-18-W70 FE65-24-520 FE79-24-520

MITSUBISHI :

A866X04871 A866X04872 A866X05470 A866X05471 A866X05472 A866X06072

MITSUBISHI MOTORS :

MD611032 MD611146

NISSAN :

23215-P0410

Unit no.

FORD

E8GY-10346A E8GY-10346B E9BZ-10346A

HYUNDAI

37300-21013 37300-21320 37900-21030

MANDO

AR160A

MAZDA

B359-18-300 B655-18-300 B655-18-300A E356-18-300A F820-18-300 FE68-18-300

FE68-18-300B N249-18-300 N249-18-300B N304-18-300 N304-18-300B N318-18-300

N320-18-300 N326-18-300

MITSUBISHI

A1T01991 A1T40391 A1T40491 A1T40791 A1T40891 A2T00991

A2T03072 A2T03691 A2T03792 A2T03892 A2T04474 A2T07577

A2T13571 A2T13571A A2T17872 A2T41677 A2T41791 A2T41991

A2T42777 A2T43791 A2T43891 A2T43892 A2T44991 A2T47371

A2T47371A A2T47474 A2T47947 A2T49891 A5T30574 A5T30871

A5T40374 A5T41474

MITSUBISHI MOTORS

MD069978 MD073067 MD074644 MD074645 MD074992 MD082419

MD091793 MD091794 MD091849 MD091850 MD099624 MD099625

MD106508 MD108305 MD109741 MD111151 MD111607

VR-H2009-50

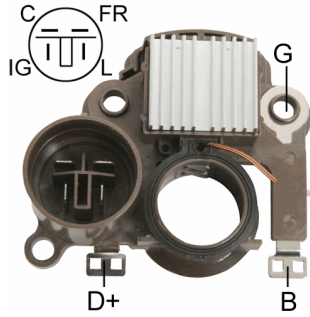

*C-FR-IG-L Terminals
 *Repair Circuit:VR-H2009-50S
 *Voltage Set Point:14.5V

Replaces

MITSUBISHI :
 A866X26641

Unit no.

HONDA
 AHGA19
 MITSUBISHI
 A5T06491ZC

VR-H2009-51

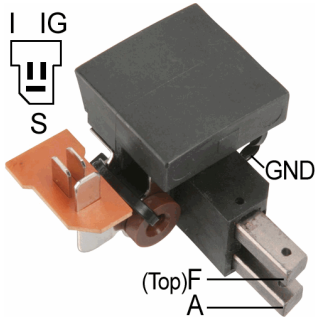

*S-IG-L Terminals
 *Voltage Set Point:14.5V

Replaces

MITSUBISHI :
 A866T01871 A866X01871

NISSAN :
 23215-W1710

Unit no.

MAZDA
 4813-18-300
 MITSUBISHI
 A2T25377 A2T25378 A2T25578 A2T25584 A2T25598 A3T32977
 A3T32989 A3T33678 A3T33684 A3T33698
 NISSAN
 23100-17S10 23100-17S15 23100-G3710 23100-G3711 23100-G3715 23100-G3716
 23100-W1710 23100-W1714 23100-W1715 23100-W1719

VR-H2009-52

*R-L Terminals
*Voltage Set Point: 14.5V

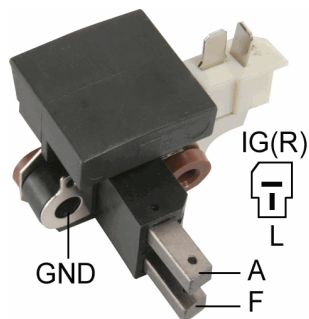

Replaces

MAZDA :
S501-24-520

MITSUBISHI :
A866X02470

Unit no.

MAZDA

S202-18-300A	S203-18-300	S501-18-300D	S502-18-300C	S509-18-300C
--------------	-------------	--------------	--------------	--------------

MITSUBISHI

A1T23579	A1T31179	A2T25679
----------	----------	----------

VR-H2009-53

*R-L Terminals
*Voltage Set Point: 14.5V

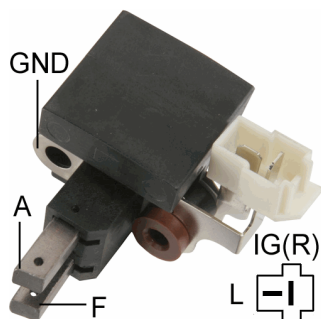

Replaces

MAZDA :
8599-24-520

MITSUBISHI :
A866X02170

Unit no.

MAZDA

8599-18-300	S201-18-300	S201-18-300A	S241-18-300	S241-18-300A
-------------	-------------	--------------	-------------	--------------

MITSUBISHI

A1T23479	A1T32779	A2T25470
----------	----------	----------

VR-H2009-54

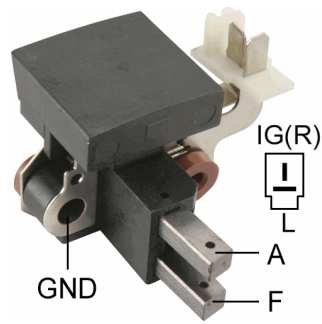

*R-L Terminals
*Voltage Set Point:14.5V

Replaces

MITSUBISHI :
A866X01670

MITSUBISHI MOTORS :
MD607500

Unit no.

MITSUBISHI

A2T24884 A3T21584

MITSUBISHI MOTORS

MD050190 MD050194

VR-H2009-55

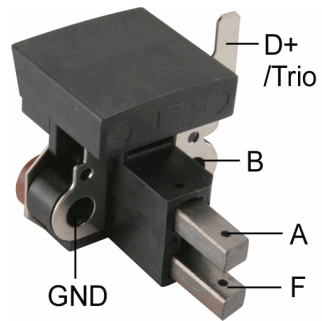

*24V
*L Terminal
*Voltage Set Point:28.3V

Replaces

MAZDA :
SE01-24-520

MITSUBISHI :
A866X02370

Unit no.

MAZDA

SE01-18-300C SE01-18-300D

MITSUBISHI

A1T70379 A2T70879

VR-H2009-56

*S-L Terminals
*Voltage Set Point: 14.6V

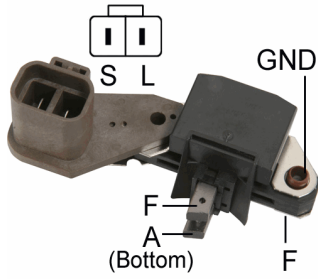

Replaces

MITSUBISHI :
A866X05870

NISSAN :
23215-05E16

Unit no.

MITSUBISHI

A3T35278 A3T35299

NISSAN

23100-05E18 23100-05E70

VR-H2009-57

*R-L Terminals
*Voltage Set Point: 14.7V

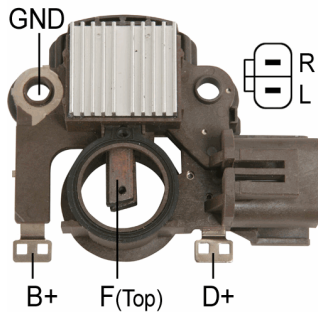

Unit no.

MITSUBISHI

A7T02874

VR-H2009-58

*Repair Circuit: VR-H2009-58S
*Voltage Set Point: 14.6V

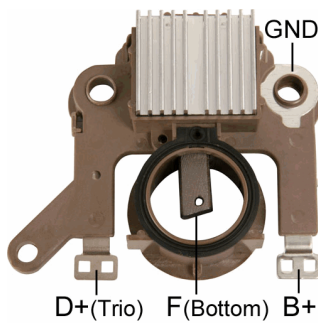

Unit no.

MITSUBISHI

A2TA0591 A2TA0592 A2TA1981 A2TA1994 A2TA2091 A2TA2094
A2TA2094B

VR-H2009-59

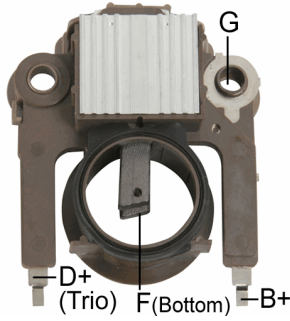

*Repair Circuit:VR-H2009-59S
 *For 28mm OD slip ring
 *Voltage Set Point:14.6V

Replaces

MITSUBISHI :
 263

Unit no.

MITSUBISHI

A2T34598

A4T00891

A4T02891

A4T02892

A4T03292

A4TA0091D

VR-H2009-5H

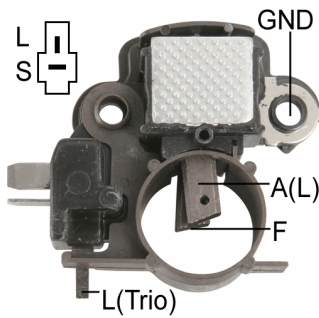

*S-L Terminals
 *Repair Circuit:VR-H2009-5S
 *Voltage Set Point:14.6V

Replaces

MITSUBISHI :

A866X06270

A866X06272

NISSAN :

23133-04F10

SUBARU :

23815-AA000

Unit no.

MITSUBISHI

A2T45272

A2T45272A

A3T01691

A3T03891

NISSAN

23100-04F10

23100-04F11

23100-04F91

SUBARU

23700-AA060

23700-AA061

VR-H2009-62

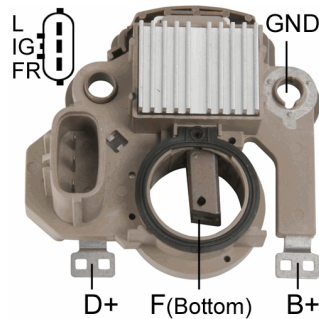

*L-IG-FR Terminals
 *Voltage Set Point:14.5V

Replaces

MITSUBISHI :

A866X31882

Unit no.

MITSUBISHI

A5TA1191ZC

VR-H2009-63

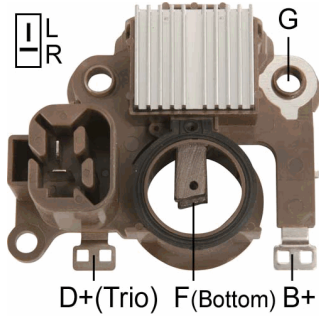

- *Inactive Lamp
- *R-L Terminals
- *Voltage Set Point:14.7V
- *w/o capacitor

Replaces

MITSUBISHI :
A866X26172

MITSUBISHI MOTORS :
MD618845

Unit no.

MITSUBISHI

A1T06391	A1T06672	A1T06791	A1T06891	A1TA0091	A1TA0291
A1TA0491	A1TA0591	A1TA0691	A1TA0791	A1TA0991	

MITSUBISHI MOTORS

MD300720	MD305885	MD305886	MD309331	MD311138	MD311711
MD311712	MD317530	MD317531	MD319045	MD319317	MD319575

VR-H2009-64

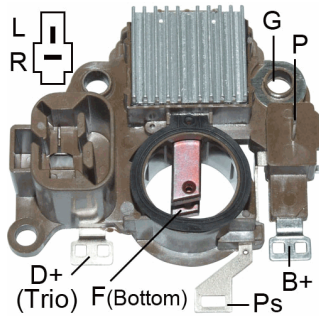

- *R-L Terminals
- *Voltage Set Point:14.7V

Replaces

MITSUBISHI :
A866X24572

Unit no.

MITSUBISHI

A7T02077A	A7TA0477
-----------	----------

VR-H2009-64A

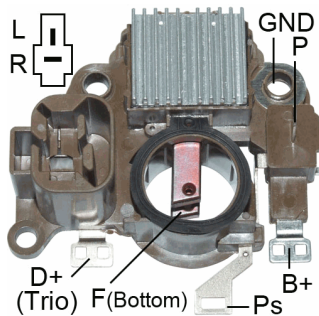

- *R-L Terminals
- *w/ Choke
- *Voltage Set Point:14.7V
- *Regitar No.:VRH2009-64M

Replaces

MITSUBISHI :
MM502585

VR-H2009-65

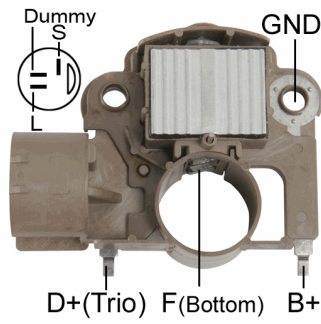

*S-L Terminals
*Voltage Set Point: 14.5V

Replaces

MITSUBISHI :
A866X17272

Unit no.

MITSUBISHI
A2T09591
NISSAN
23700-AA180

VR-H2009-66TF

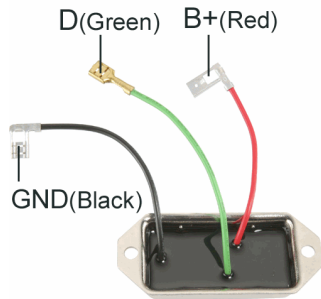

*VR-H2009-66 Test Fixture

VR-H2009-67

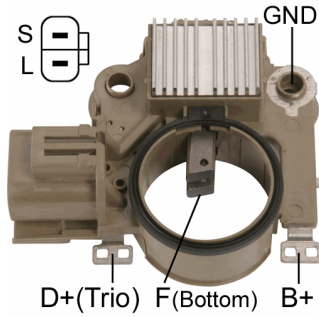

*S-L Terminals
*Voltage Set Point:14.5V

Replaces

MAZDA :

RGF1-18-W70

MITSUBISHI :

A866X24972

A866X25572

A866X24472

A866X24972

A866X38472

MD618735

MD619167

MITSUBISHI MOTORS :

MD618735

Unit no.

HYUNDAI

37300-42354

37300-42356

MITSUBISHI

A2T37976

A2TN0076

A2TN0199

A2TN0299

A2TN0399

A2TN0499

A2TN0599

A3T11678

A3TN0078

A3TN0199

A3TN0299

A3TN0399

A3TN0499

A3TN0699

A3TN15099

Used On

HYUNDAI

Starex

MITSUBISHI

L300

VR-H2009-69

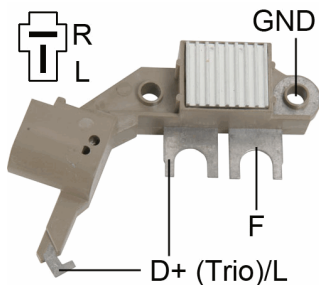

*R-L Terminals
*Voltage Set Point:14.7V

Replaces

MITSUBISHI :

A866X08971

A866X23972

MITSUBISHI MOTORS :

ME700799

ME701260

Unit no.

MITSUBISHI

A004T25788

MITSUBISHI MOTORS

ME015164

VR-H2009-6H

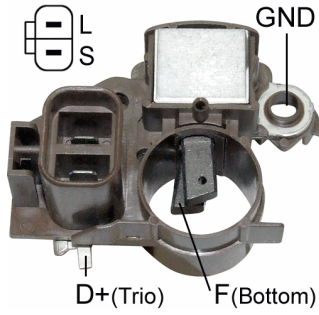

*S-L Terminals
 *Repair Circuit:VR-H2009-5S
 *Voltage Set Point:14.6V

Replaces

LUCAS :

21513125 UCJ235

MAGNETI MARELLI :

940038088

MITSUBISHI :

A866T05270	A866X05270	A866X05272	A866X09071	A866X09771	A866X09782
A866X12472					

MITSUBISHI MOTORS :

MD611432	MD611565	MD611588	MD611710	MD618483
----------	----------	----------	----------	----------

NISSAN :

23125-04P10	23215-04P10
-------------	-------------

Unit no.

HYUNDAI

37300-32520	37300-35020
-------------	-------------

MITSUBISHI

A2T02271	A2T02471	A2T03471	A2T03477	A2T03972	A2T04271
A2T04992	A2T06871	A2T09493	A2T09691	A2T09792	A2T14792
A2T17692	A2T40671	A2T48176	A2T48176A	A2T48176B	A2T48195
A2T48195A	A2T48195B	A2T48691	A2T48791	A2T49972	A2T49977
A2T49992	A3T00692	A3T00792	A3T02192	A3T02193	A3T03393
A3T03493	A3T04292	A3T04493	A3T41876	A3T41892	A3T45693
A3T45694	A5T41094				

MITSUBISHI MOTORS

MD061150	MD102084	MD102085	MD102088	MD105339	MD106713
MD108230	MD108509	MD109166	MD110318	MD111233	MD112322
MD114620	MD117156	MD122338	MD125569	MD126110	MD134315
MD136838	MD136839	MD140247	MD141855		

NISSAN

23100-02E10	23100-02E11	23100-02E15	23100-02E16	23100-05P11	23100-05P12
23100-14P11	23100-14P12	23100-15P11	23100-15P12	23100-15P13	23100-15P90
23100-15P91	23100-42L11	23100-42L71			

VR-H2009-6HL

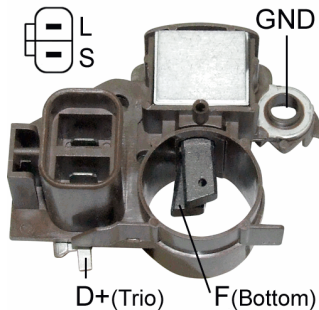

*S-L Terminals
 *Voltage Set Point:14.4V
 ** For Iran Market Only

Replaces

KIA :

KK137-24-W70

Unit no.

KIA

M13NI-18-300B

VR-H2009-70A

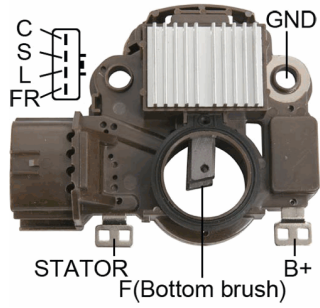

*C-S-L-FR Terminals
 *Soft Start
 *Repair Circuit:VR-H2009-70AS
 *Voltage Set Point:14.4V

Replaces

MITSUBISHI :
 A866X34172 MD619268

MITSUBISHI MOTORS :
 MD619268

Unit no.

MITSUBISHI					
A2TA4991	A2TA5191	A2TA5192	A2TA5391	A2TB0892	A3TA1691
A3TA2291A	A3TA4691	A3TA4791	A3TA5291	A3TA5491	

VR-H2009-71

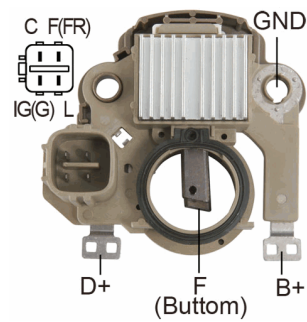

*C-F(FR)-IG-L Terminals
 *Voltage Set Point:14.5V

Unit no.

MITSUBISHI
 A5TA0991

VR-H2009-73

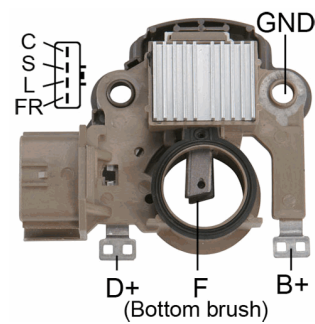

*C-S-L-FR Terminals
 *Repair Circuit:VR-H2009-73S
 *Voltage Set Point:14.4V

Replaces

MITSUBISHI :
 A866X28572

MITSUBISHI MOTORS :
 MD618957

Unit no.

MITSUBISHI		
A2T82791	A2TA0891ZC	A5TA0291
MITSUBISHI MOTORS		
MD313392		

VR-H2009-75

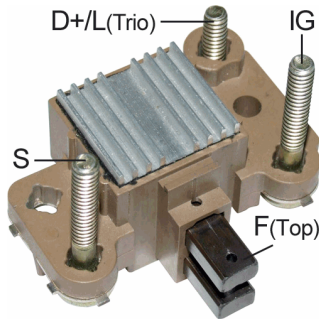

*Excitation: Trio/A
*Voltage Set Point:14.6V

Replaces

MANDO :		
809163	811883	A500C0111
MELROE :		
6659393		
VALEO :		
809163	811883	A500C0111

Unit no.

MANDO					
A000B0331	A000B0431	AC155603	AC155604	AC155614	AC165617
AC155515 AC155643					
MELROE					
6661611					

VR-H2009-77B

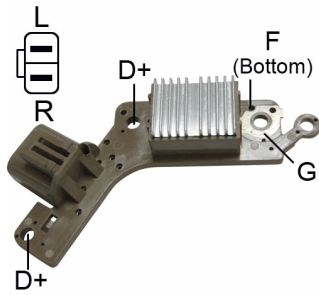

*24V
*L-R Terminals
*Voltage Set Point:28.5V

Replaces

MITSUBISHI :	
A866X26070	A866X26072
MITSUBISHI MOTORS :	
ME701302	

Unit no.

MITSUBISHI					
A004T40286	A004T40289	A004T40386	A004T40389	A004T70086	A004T70099
A004T70189	A004T95099	A004TU3088	A004TU3186		
MITSUBISHI MOTORS					
ME017632	ME077788	ME077789	ME077790	ME077869	ME092899
ME093245	ME093246	ME160917	ME160918		

VR-H2009-78

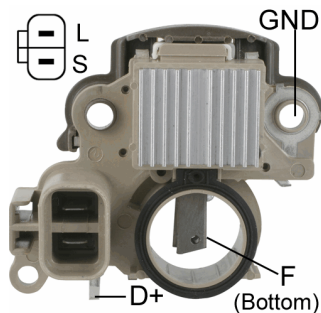

- *L-S Terminals
- *Inactive Lamp
- *S Open Lamp Off
- *Voltage Set Point: 14.5V

Replaces

MITSUBISHI :

A866T09780 A866T09782

Unit no.

HYUNDAI

37300-32800 37300-33010 37300-33013 37300-33030 37300-33100 37300-33101
 37300-33103

MANDO

AB175020 AB190025 AB190072 AB190119

MITSUBISHI

A3T03393

MITSUBISHI MOTORS

MD136838

VR-H2009-79

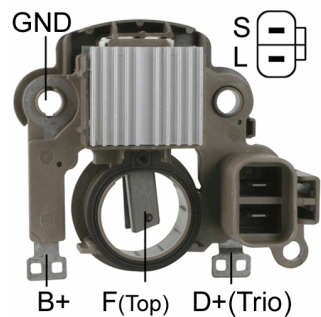

- *S-L Terminals
- *Voltage Set Point:14.5V

Replaces

MITSUBISHI :

A866X27572

MITSUBISHI MOTORS :

ME701363

Unit no.

MITSUBISHI

A2TA3098 A3T09198 A3T09199 A3T09698 A3T09699 A3T09799
 A3TA3098 A3TA4298 A3TA6098

VR-H2009-7H

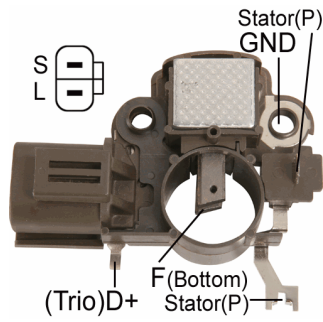

*S-L Terminals
 *Repair Circuit:VR-H2009-7S
 *Voltage Set Point:14.6V

Replaces

FORD :

E8GY-10316B E8GZ-10316A

MAGNETI MARELLI :

940038084

MAZDA :

B675-18-W70 B675-18-70A

MITSUBISHI :

A866X12980 A866X29272 A866X12770 A866X12772 A866X12780 A866X12782

Unit no.

FORD

E8GY-10346C E8GY-10346D E92Z-10346A E92Z-10346B F2F8-18300B

MAZDA

B675-18-300A B675-18-300B F202-18-300 F881-18-300A

MITSUBISHI

A2T05772 A2T05892 A2T05893 A2T20091

VR-H2009-80

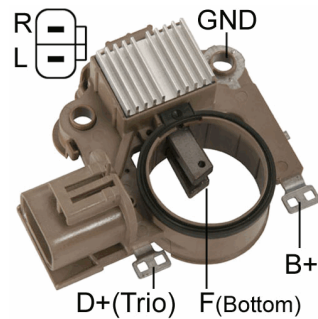

*L-R Terminals
 *Voltage Set Point:14.7V

Unit no.

MITSUBISHI

A2T38776 A2T36776

VR-H2009-80B

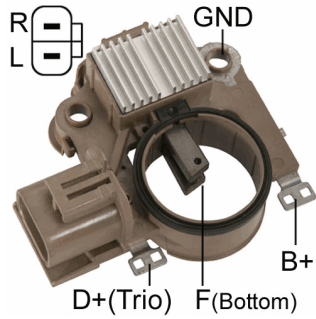

*24V
 *R-L Terminals
 *Repair Circuit: VR-H2009-80BS
 *Voltage Set Point:28.6V

Replaces

MITSUBISHI :
 A866X28372 A866X41272 ME701399
MITSUBISHI MOTORS :
 ME701399

Unit no.

MITSUBISHI
 A3T75883 A3TN5188 A3TN5288
 MITSUBISHI MOTORS
 ME017615

VR-H2009-82

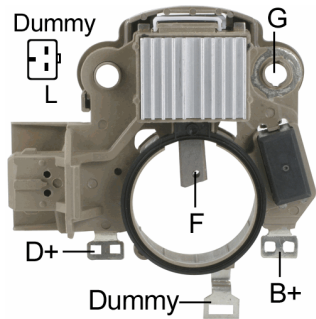

*D-L Terminals
 *Voltage Set Point:14.3V

Replaces

MITSUBISHI :
 A866X40371

Unit no.

MITSUBISHI
 A3TN1791

VR-H2009-83

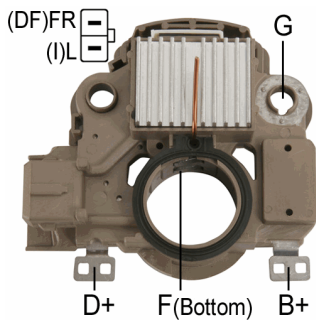

*FR-L Terminals
 *Repair Circuit: VR-H2009-83S
 *Voltage Set Point:14.5V

Replaces

MITSUBISHI :
 A866X35872

Unit no.

MITSUBISHI
 A5TA2591 A5TA4391 A5TA6591

VR-H2009-85

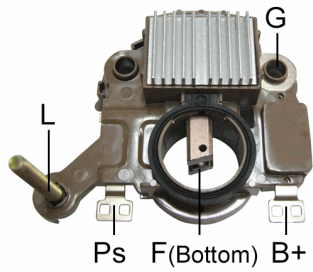

- *Active Lamp
- *Short Circuit Protection
- *Voltage Set Point:14.6V

Replaces

MITSUBISHI :
234309

Unit no.

MITSUBISHI
A2TB4891A

VR-H2009-88

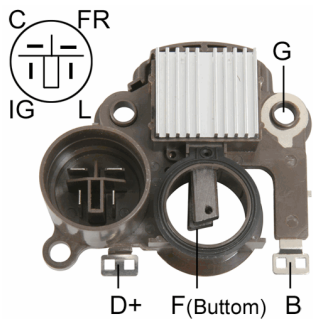

- *C-FR-IG-L Terminals
- *Repair Circuit:VR-H2009-88S
- *Voltage Set Point:14.5V

Replaces

MITSUBISHI :
A866T29570 A866X29582 VR295

Unit no.

HONDA
31100-P0G-A03,
MITSUBISHI
A2TA2191

VR-H2009-8H

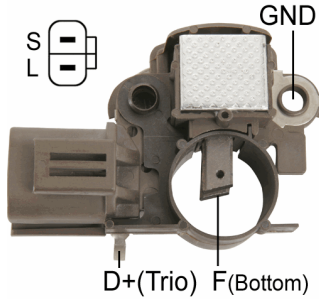

*S-L Terminals
 *Repair Circuit:VR-H2009-7S
 *Voltage Set Point:14.6V

Replaces

LUCAS :

21513126 UCJ233

MITSUBISHI :

A866X08070 A866X08071 A866X08072

NISSAN :

23215-17B10 23215-51S10

Unit no.

MITSUBISHI

A2T02394 A2T02394B A2T46395 A2T46395B A2T47794 A2T47794B

A2T48292 A2T48298 A2T48472

NISSAN

23100-12C10 23100-12C11 23100-26E10 23100-26E11 23100-51S10 23100-D4410

23100-D4415 23160-07F11 23300-D4110

VR-H2009-90

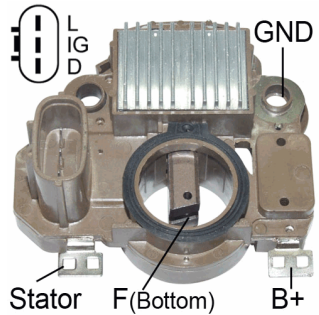

*Inactive Lamp
 *Soft Start
 *8 sec. LRC
 *L-IG-D Terminals
 *Short Circuit Protection
 *Voltage Set Point:14.6V

Unit no.

GM

30020754

MITSUBISHI

A5TA4291 A5TA4291ZC

SUZUKI

31400-65D00 31400-65D01

VR-H2009-92

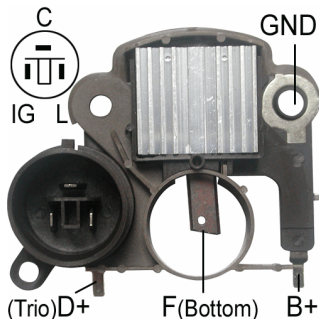

*C-IG-L Terminals
 *Voltage Setting:14.5V

Replaces

MITSUBISHI :

A866X13571

VR-H2009-93

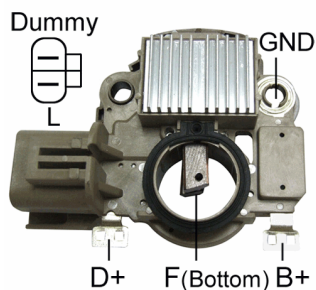

- * D-L Terminals
- * Inactive Lamp
- * L Terminal Does Not Drive Choke
- * Voltage Set Point: 14.5V

Replaces

MITSUBISHI :
517

Unit no.

MITSUBISHI
A003TB5391 A3TA0991A A3TB5391
MITSUBISHI MOTORS
MD354802

VR-H2009-94

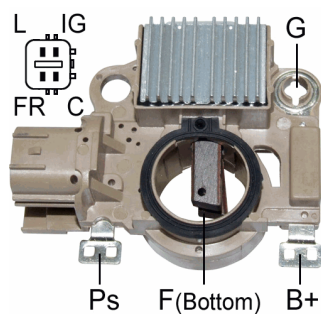

- *L-IG-FR-C Terminals
- *Voltage Set Point: 14.5V

Replaces

HONDA :
31150-PYM-004

MITSUBISHI :
487 A866X48782

Unit no.

MITSUBISHI
A007TA1891

Used On

HONDA

Civic 1.7L
Civic 1.7L

2001-
2002-2004

VR-H2009-95

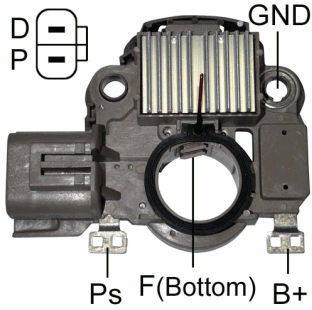

- * Inactive Lamp
- * D-P Terminals
- * Repair Circuit: VR-H2009-95S
- *** Traditional test method will immediately damage P-D regulator. Avoid damage using Mobiletron VR-H2009-66TF test fixture.

Replaces

MITSUBISHI :

A866X35472	A866X34572	475	505	561
------------	------------	-----	-----	-----

Unit no.

MITSUBISHI

A2TB0091	A2TB2391
----------	----------

VR-H2009-96B

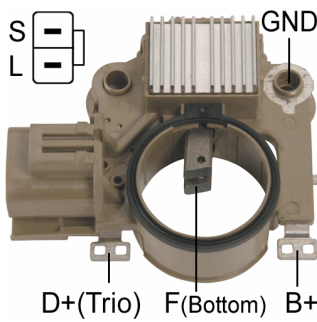

- *24V
- *S-L Terminals
- *Voltage Set Point:28.4V
- *L Terminal Does Not Drive Choke

Replaces

MITSUBISHI :

A866X38672

Unit no.

MAZDA

A2T74684	A2T74776	A2T74876	A2T74976	A2T75076	A2T75176
A2T75282	A2T75376	A2T75476	A2T75576	A2TN5084	A2TN5384
A3TN5684	A3TN6579	A3TN6679			

Used On

MAZDA

Titan DE	HA24,SL24
Titan DE	TF24 VS24
Titan DE	TF24
Titan DE	TF24, TM24
Titan DE	SL24
Titan DE	HA24
Titan LPG	TF24

VR-H2009-97

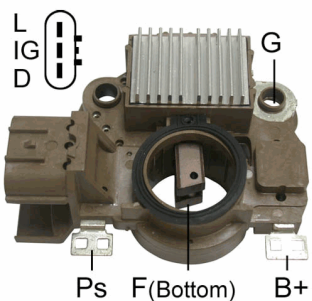

- *L-IG-D Terminals
- *6 sec. LRC
- *L Terminal Does Not Drive Choke
- *Voltage Set Point: 14.5V

Replaces

MITSUBISHI :

A866X45072

VR-H2009-98

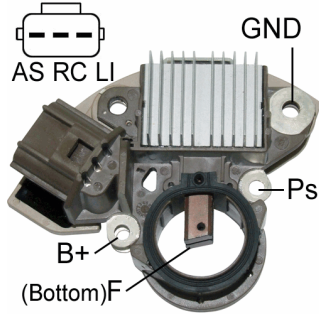

- *AS-RC-LI Terminals
- *W/Capacitor 0.5uF
- *Voltage Set Point:14.0V
- *Regulated Voltage Control(RVC)
- *Requires VR-RVC01 test adaptor for testing

Replaces

MITSUBISHI :
A866T52970

Unit no.

FORD

4W73-10300AC 4W7Z-10346AC 6E5T-10300AB 6E5T-10300AD 7E5T-10300AA

MITSUBISHI

A3TJ0991ZC A004TJ0181ZC A3TJ0891 A3TJ0891ZC A4TJ0181 A4TJ0181ZC

Used On

FORD

Crown 2004-2006
Fusion 2006-2008

VR-H2009-99

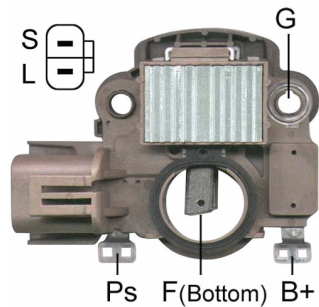

- * Inactive Lamp
- * L-S Terminals
- * Repair Circuit:VR-H2009-99S
- * Soft Start
- * Load Response Control
- * w/Capacitor
- * w/o Drive Choke
- * Voltage Set Point:14.5V

Replaces

MITSUBISHI :
A866X37272 A866X47672

Unit no.

MITSUBISHI

A2T05892C A2T33191A A2T33991A A2T36578A A2TA1099A A2TA6099A

A3TB4291

NISSAN

23100-AM610

Used On

INFINITI

M45 8 Cyl. 4.5L 2003-2004

VR-H2009-9H

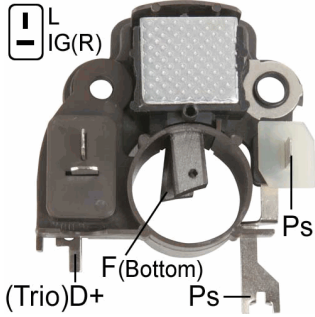

*R-L Terminals
 *Repair Circuit:VR-H2009-4S
 *Voltage Set Point:14.6V

Replaces

- FORD :**
 E7GZ-10316A F0BZ-10316A
- LUCAS :**
 21513133
- MAGNETI MARELLI :**
 940038086
- MAZDA :**
 BF1462 FE85-18-W70
- MITSUBISHI :**
 A866X07570 A866X07572
- MOTORCRAFT :**
 GRE800

Unit no.

FORD					
E7GZ-10346A	E8BZ-10346A	E8BZ-10346B	FOBZ-10346A	FOCZ-10346B	
MAZDA					
B101-18-300	B10-18-300A	B603-18-300	B603-18-300A	F651-18-300B	FE85-18-300
MITSUBISHI					
A5T16471	A5T30977	A5T31177	A5T31971	A5T31971A	

VR-H2003-1B

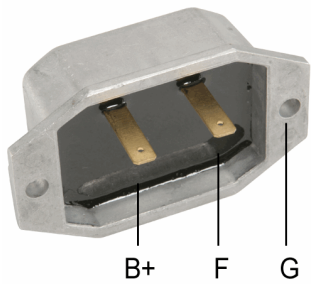

*24V
 *B+ - F Terminals
 *Voltage Set Point:28.5V

Replaces

ISUZU :

1-81251-004-0 1-81251-024-0 5-81251-012-0

NIKKO :

1-44000-0580 1-44000-0730

Unit no.

ISUZU

1-81200-206-0	1-81200-209-0	1-81200-234-0	1-81200-265-0	1-81200-314-0	1-81200-459-0
1-81200-536-0	1-81200-541-0	1-81200-541-1	1-81200-544-1	1-81200-545-0	1-81200-545-1
1-81200-549-0	1-81200-551-0	1-81200-554-0	1-81200-558-0	1-81200-585-0	1-81200-844-0
5-81200-212-0					

NIKKO

0-33000-0050	0-33000-0060	0-33000-0071	0-33000-0120	0-33000-2200	0-33000-2280
0-33000-2290	0-33000-2800	0-33000-2841	0-33000-2870	0-33000-2871	0-33000-2880
0-33000-3070	0-33000-3071	0-33000-3130	0-33000-3700	0-33000-3710	0-33000-3760
0-33000-3810	0-33000-3970	0-33000-4400	0-33000-4402	0-33000-4670	0-33000-4750
0-33000-5100	0-33000-5280				

VR-H2003-2B



*24V
 *Voltage Set Point:28.8V

Replaces

NIKKO :

1-44000-0900	0-33719-0030	0-33719-0031	7-44000-0901	0-33719-0100	0-33719-0120
1-44000-0900	7-44000-0900	7-44000-0903	7-44000-0905	7-44000-0906	7-44000-0920

VR-LC401

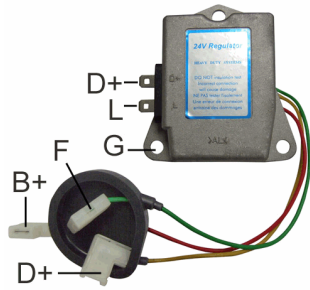

- *24V
- *W/surge protection
- *Voltage Set Point:28.3V

Replaces

PRESTOLITE :
1861A726 594A-11 594A-14

Unit no.

PRESTOLITE
AC203RA

VR-H2002-1

*24V
 *R-L-F-E-LA-N Terminals
 *Voltage Set Point:28.3V

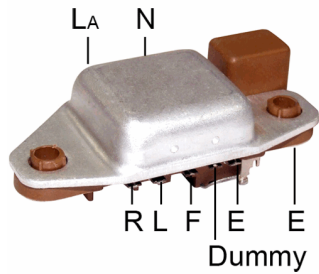

Replaces

HINO :
 27700-1700
NISSAN :
 23500-Z9007
SAWAFUJI :
 1291-008-00X0
TOYOTA :
 27700-1700

Unit no.

NISSAN					
23099-96510	23099-Z5615	23099-Z5665	23100-97507	23100-Z5617	
SAWAFUJI					
0201-102-2921	0201-102-2963	0201-102-3110	0201-102-3112	0201-152-0010	0201-152-0021
0201-152-0043	0201-152-0053	0201-172-0013	0201-172-0112	0201-172-0121	0201-202-0011
0201-202-0210	0201-222-0013	0201-222-0023	0201-222-0113	0201-222-0220	0201-222-0262
0201-222-0272	0201-222-0312	0201-222-0412	0201-222-0421	0202-102-1811	0202-102-1823
0202-102-1910	0202-102-1921	0202-102-1933	0202-102-1943	0202-152-0010	0202-152-0021
0202-152-0033	0202-152-0043	0202-152-0123	0202-202-0011	0202-222-0012	0202-222-0023
0202-222-0110	0202-222-0142	0202-222-0152	0202-222-0211	0202-222-0222	
TOYOTA					
27040-1811					

VR-H2002-2

*24V
 *L-F-C-E Terminals
 *Voltage Set Point:28.7V

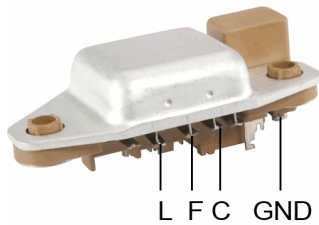

Replaces

NISSAN :
 23500-Z9003
SAWAFUJI :
 1291-007-00X0

Unit no.

NISSAN					
23099-96504	23099-965503	23099-Z5604	23099-Z5605	23100-95015	23100-Z5602
SAWAFUJI					
0201-102-1020	0201-102-1210	0201-102-1220	0201-102-1310	0201-102-1410	0201-102-1710
0201-102-2020	0201-102-2610	0202-102-1010	0202-102-1011	0202-102-1020	0202-102-1110
0202-102-1111	0202-102-1120	0202-102-1121	0202-102-1211	0202-102-1310	0202-102-1411
0202-102-1510	0210-102-2020	0214-202-0310	0214-202-0319	0220-102-1211	0220-102-1310
0220-102-1411	0220-102-1510				
TOYOTA					
27040-1400	27040-1410	27040-1440	27040-1460	27050-1240	27050-1250
27050-1260	27050-1270				

VR-H2002-3

- *24V
- *R-L-F-C-E Terminals
- *Voltage Set Point:28.7V

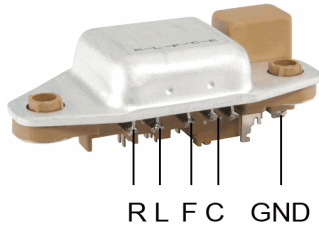

Replaces

SAWAFUJI :
1291-006-00X0

VR-V0030

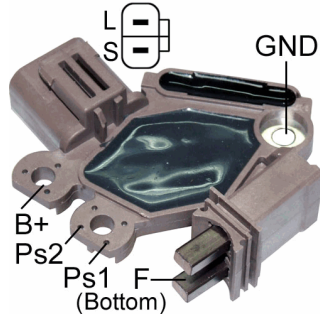

- *Soft Start
- *8.5 sec. LRC
- *Short Circuit Protection
- *Voltage Set Point: 14.6V

Replaces

VALEO :
2650030

Unit no.

NISSAN
23100-5Z000 23100-7Y020
VALEO
2650031 2650047

Used On

NISSAN

Quest 3.5L

2004-2009

VR-V005

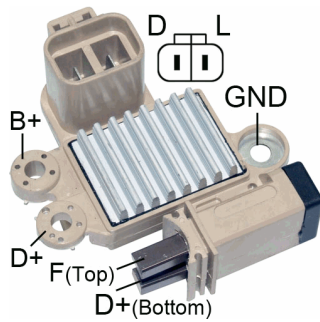

- *Voltage Set Point: 14.5V

Unit no.

HYUNDAI
37300-23720

Used On

HYUNDAI

Accent

KIA

Cerato 1.6

Cerato 1.8L

VR-V010

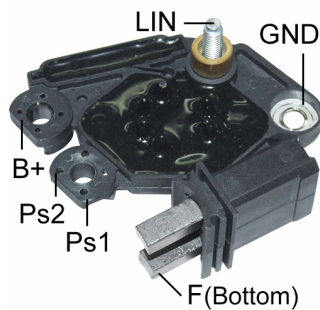

- *B-Circuit
- *LIN-1

Unit no.

FORD
7G9T-10300BE

VR-V0219

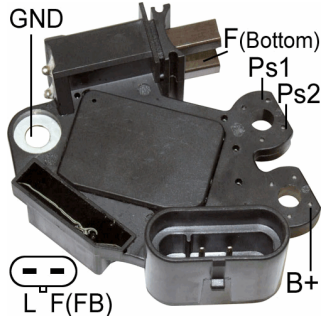

- *Soft Start
- *2.5 sec. LRC
- *Short Circuit Protection
- *Voltage Set Point: 14.6V

Replaces

VALEO :

2650219 2650348 2650473

Unit no.

VALEO

TG12C027	TG12C040	TG12C042	TG12C043	TG12C048	TG12C084
TG13S018	TG13S021	TG13S023	TG13S028	2606925	2650043
2650323B	2650323O	2650398	2650408	2650709	

VR-V0441

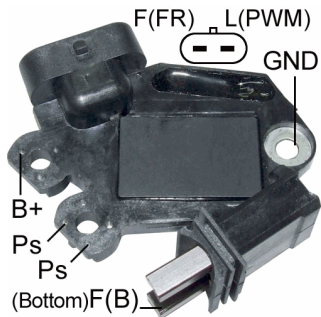

- *Voltage Set Point: 13.8V
- *Soft Start
- *2.5 sec. LRC
- *Short Circuit Protection
- *Regulated Voltage Control(RVC)
- *Requires VR-RVC01 test adaptor for testing
- *Regitar No.:VRVA0557

Replaces

VALEO :

2650441 2650561 15926088

Unit no.

GM

15201678 15215546 15251755 15784559 15863714

VALEO

TG10S012	TG10S016	TG10S017	TG10S022	2650181	2650304
2650352	2650505	TG12S028	TG12S047	TG12S089	TG13S012
TG13S017	TG13S020	TG13S029			

VR-V0447

- *C-S-L Terminals
- *Soft Start
- *Short Circuit Protection
- *Voltage Set Point:14.5V

Replaces

VALEO :
2650447

Unit no.

NISSAN					
23100-JA02A	23100-JA02B	23100-ZH00A	23100-ZH00B	23100-22DZ0A	
SUZUKI					
31400-82Z10					
VALEO					
2650538	TG15C113	TG15S147	TG12C032	2650364A	2650364B
TG12C103					

Used On

INFINITI	
QX56 5.6L	2008-2010
NISSAN	
Armada 5.6L	2007-2011
Frontier 4.0L	2008-2010
Pathfinder 4.0L	2008-2010
Pathfinder 5.6L	2008-2010
Titan 5.6L	2008-2010
Xterra 4.0L	2007-2010
Altima 2.6L	2007-2009
Sentra 2.5L	2007-2009
SUZUKI	
Equator 4.0L	2009-2010

VR-V2499

- *Soft Start
- *2.5 sec. LRC
- *Short Circuit Protection
- *Voltage Set Point:14.6V

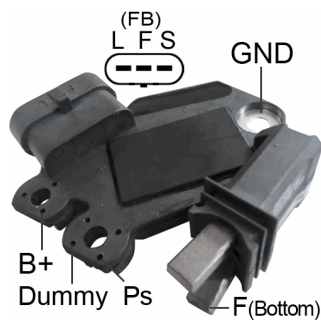

Replaces

VALEO :
2542499

Unit no.

GM				
10317648	10327514	10350160		
VALEO				
2650010	2650011B	2650017A	SG10S029	SG10S035

VR-V2604

*BSS Connections

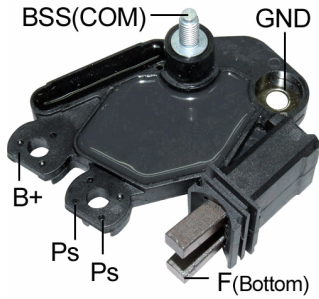

Replaces

VALEO :

595365	2543535	591894	2543505	2591579	2591894
593263					

Unit no.

BMW

12317802261	12317802619	12317573754	12317573755	12317533469	12317561002
12317801124	12317804266				

VALEO

439602	439606	2543436	2543218	2543223	TG23C011
TG23C012	TG23C013	TG23018	FG18S019	439613	440183
543461A					

Used On

BMW

Truck X5 6Cyl. 3.0L	2009-2010
X5 6Cyl. 3.0L Diesel	2009-2010
X5 8Cyl. 4.8L	2007-2010
X6 6Cyl. 3.0L	2008-2010

VR-V3406SE

- *Soft Start
- *2.5 sec. LRC
- *Short Circuit Protection
- *Self Exciting
- *Voltage Set Point: 14.4V

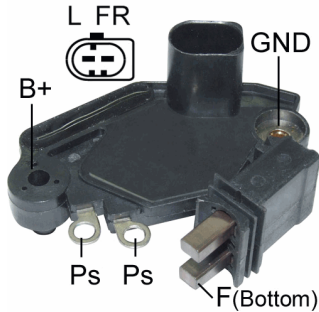

Replaces

VALEO :

593406	YR3634VFP2
--------	------------

Unit no.

VALEO

A14VI34	A14VI45	A14VI46	A14VI47
---------	---------	---------	---------

VR-V3666

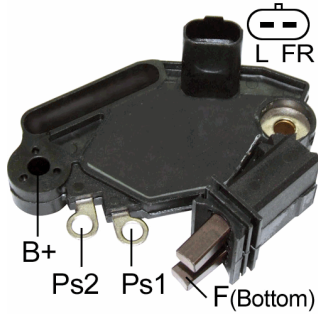

- *Soft Start
- *8.5 sec. LRC
- *Short Circuit Protection
- *Voltage Set Point: 14.6V

Replaces

VALEO :

593666 YM1689PF 2549916B

Unit no.

RENAULT

7711134926 8200138269 8200290220

VALEO

2542588 2542637 2542751 2542819 2543343 2543344

2543595 2543596 SG15L020 SG15L027 SG15L034

VR-V3689

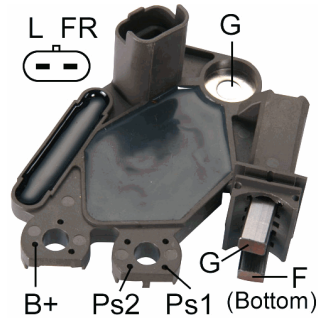

- *Soft Start
- *8.5 sec. LRC
- *Short Circuit Protection
- *Voltage Set Point: 14.6V

Replaces

VALEO :

593689 YR1615PF

Unit no.

VALEO

SG12B081 SG12B09 SG12B096 SG12B097 SG12B103 TG11C010

TG11C011 TG11C022 TG11C027 TG11C034 TG11C049 TG15C058

TG8S017 SG12B105 SG12B109 SG12B110 SG12B052 SG12B055

SG12B068 SG12B071 SG12B072 SG12B081 SG12B09 SG12B096

SG12B097 SG12B103 SG12B105

VR-V3779

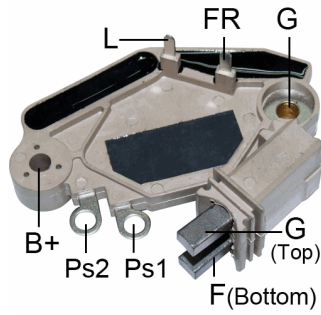

- *Soft Start
- *8.5 sec. LRC
- *Short Circuit Protection
- *Voltage Set Point: 14.6V

Replaces

VALEO :
593779 YM1693VFP 2542566

Unit no.

VALEO
SG15L012 SG15L026

Used On

CITROEN

Berlingo 1.1i	MFHDZ	2002-2002
Berlingo 1.1i	MFHFX	2002-2002
Berlingo 1.6 16V	MFNFU	2000-2002
Saxo 1.0		1996-
Saxo 1.4 VTS		1999-
Saxo 1.6 VTL		

MERCEDES-BENZ

Vaneo 1.7L DSL		2002-2005
----------------	--	-----------

VR-V3780

- *BSS Connections

Replaces

VALEO :
593780 YR0636D15

Unit no.

VALEO
SG12B062

Used On

MERCEDES-BENZ

C230 1.8L		2003-2004
-----------	--	-----------

VR-V3796

*BSS Connections

Replaces

VALEO :

593796	595200	599101	2543200	2543503	2591504
2591582					

Unit no.

VALEO

TG17C010	TG17C010B	TG17C011	TG17C048
----------	-----------	----------	----------

Used On

BMW

M5 V10 5.0L	2006-2010
M6 V10 5.0L	2006-2010

VR-V3874

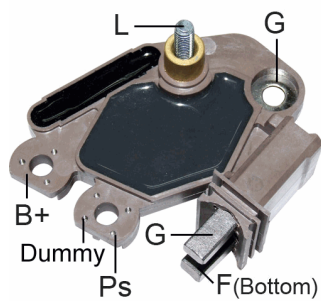

- *Soft Start
- *2.5 sec. LRC
- *Short Circuit Protection
- *Voltage Set Point: 14.6V

Replaces

VALEO :

593874	593454	YM1666FP5
--------	--------	-----------

Unit no.

VALEO

SG9B037	SG9B038	SG9B039
---------	---------	---------

VR-V4114

*BSS Connections

Replaces

VALEO :

2543208	2604774	595253
---------	---------	--------

Unit no.

RENAULT

8200410669	8200588648	8200667619
------------	------------	------------

VALEO

TG11C039	TG11C055	TG11C060
----------	----------	----------

VR-V5001

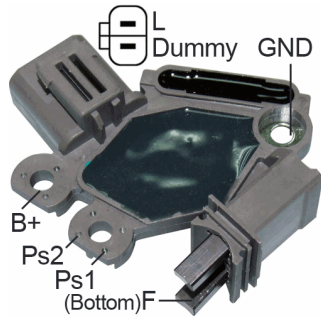

- *Soft Start
- *8.5 sec. LRC
- *Short Circuit Protection
- *Voltage Set Point: 14.6V

Replaces

VALEO :

2655001	20051012	2655479
---------	----------	---------

Unit no.

HYUNDAI

37300-37400	37300-37405
-------------	-------------

KIA

QK2AA-18-300	RK2AA-18-300U
--------------	---------------

VALEO

2655516	2655553	A0002655010	A0002655516	TG11C024
---------	---------	-------------	-------------	----------

VR-V5428

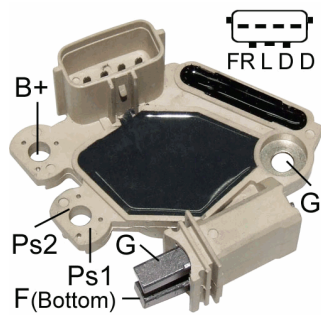

- *Soft Start
- *2.5 sec. LRC
- *Short Circuit Protection
- *Voltage Set Point: 14.6V

Replaces

VALEO :

2655428

Unit no.

HYUNDAI

37300-38400

VALEO

A0002655009

Used On

HYUNDAI

Santa 2.4 16V	2001-2006
---------------	-----------

Sonta 2.0 16V	2001-2004
---------------	-----------

Santa 2.7 V6 4X4	2001-2004
------------------	-----------

Sonta 2.7 V6	2001-2004
--------------	-----------

KIA

Magentis 2.0	2003-2006
--------------	-----------

VR-V6131

*Voltage Set Point: 14.5V

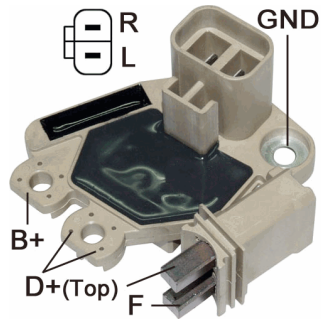

Replaces

VALEO :
13480351

Unit no.

MITSUBISHI
37300-02550

Used On

HYUNDAI

Gets 1.1L	2002-2006
Amica 1.0L	2001-2003
Amica 1.1L	2004-2008

KIA

Picanto 1.0L	2004-2008
Picanto 1.1L	2004-2008

VR-V8326

Replaces

VALEO :
2608326

Unit no.

KIA
37300-2B101
VALEO
2655447

Used On

KIA

Soul 1.6L	2010-
Carens 1600	2009-2012
Pro Ceed 1400	2007-2012
Pro Ceed 1600	2007-2012

VR-DU509

*Voltage Set Point:15.5V

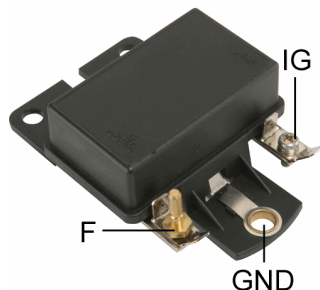

Replaces

BOSCH :

0-190-601-014 9-190-110-539

FEMSA :

GRO12-10 GRO12-12 GRO12-7

LUCAS :

21930022 37696 NCB203 NCB212

PEUGEOT :

5761.28 5761.29 5761.31

PORSCHE :

91160390100

SEV MARCHAL :

33505 33523 71270402 72711202 72711502

TALBOT :

15224800 15224891 30201E 373994J 461138S

VALEO :

505046 77616 79905 NB973 NC334

VALEO(DUCELLIER) :

519004 8358 8367 8373 8380

VALEO(MOTOROLA) :

9RH7014

VALEO(PARIS RHONE) :

AYA2114 AYB214 AYB216 YL142

VOLVO :

6877982

Unit no.

VALEO

2074684	2077791	2093051	2093073	2095084	2095085
2095086	2095172	2095228	2095565	2095722	2097295
2097973	2102452	40170302	433396	436305	512002
512002A	512002B	512003	512003A	512003B	71211302
71220002	71220102	71220402	71220602	71220702	71220902
71221002	71223202	71223402	71223602	71223802	71226602
71227702	71270102	71270202	71270302	71270402	71271002
71273702	71427002	71923002	7250	7258C	7526
7526B	7526C	7528B	7531	7531B	7543
7543A	7543B	7545	7545A	7552	7552A
7552AB	7552B	7552C	7552D	7554	7554A
7560	7560A	7560B	7560C	7565	7565A
7565AB	7565B	7565C	7565D	7565DE	7565E
7566	7566A	7566AB	7566B	7566C	7567
7567A	7567AB	7567B	7567C	7567D	7567DE
7567E	7568	7568A	7568AB	7568B	7568C
7569A	7569ABC	7569B	7569C	7569D	7570
7570A	7570B	A12M1	A12M10	A12M18	A12M2
A12M3	A12M6	A12M7	A13M11	A13M13	A13M15
A13M16	A13M17	A13M2	A13M5	A13M7	A13M8
A13R127					

VR-DU510

*Voltage Set Point:14.5V

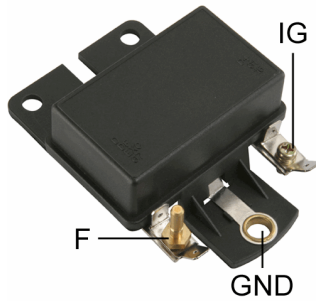
**Replaces****BOSCH :**

9-190-110-031 9-190-110-034 9-190-110-041

CITROEN :

5491551 AK5351

FEMSA :

GRK12-13 GRK12-2 GRK12X-1 GRO12-2 GRO12X-1 GRO12X-9

ISKRA :

11-125-109 AER3006

LUCAS :

21930021 21931006 37175 37695 NCB201 NCB209

NCB211

MAGNETI MARELLI :

64800002

PEUGEOT :

5761.23 5761.24 5761.32 5761.33 5835.02

RENAULT :

7700519493 7700530749 7700544686 7700660469 7700666179 7701348281

SEV MARCHAL :

33036	33067	33081	33506	33518	33519
33522	33524	33525	33532	33538	33544
33545	33546	33548	33549	33560	33561
72260402	72260502	72260602	72415002	72415202	72415502
72415802	72416202	72416302	72610002	72610102	72610502
72610602	72610702	72610902	72710002	72710202	72710302
72710402	72710602	72710802	72711602	72717102	

TALBOT :

163009 42290B 55822700

VALEO :

100065	100207	505045	505048	505049	70335
70747	71854	74547	76722	76833	76834
77224	78819	79343	79368	79583	79584
79628	92361	92782	95394	96126	96637
96731	97343	97382	99464	NB175	NC333
NC886					

VALEO(DUCELLIER) :

510002	510004	510005	519001	8320	8327
8328	8347	8349	8350	8357	8362
8364	8371	8372	8376	8378	8381
8382					

VALEO(MOTOROLA) :

9RH7013 9RH7016 9RH7017

VALEO(PARIS RHONE) :

AY21	AY21T	AYA21	AYA210	AYA213	AYB21
AYB210	AYB211	AYB2110	AYB2113	AYB2115	AYB2116
AYB2118	AYB2119	AYB212	AYB2123	AYB2124	AYB2125
AYB2128	AYB213	AYB215	AYB218	YL411	

VOLVO/DAF :

01215477	01215565	114374	1259303	215565	292243
3292243					

VR-DU510

Unit no.

VALEO

2074684	2077791	2093051	2093073	2095084	2095085
2095086	2095172	2095228	2095565	2095722	2097295
2097973	2102452	433396	436305	512002	512002A
512002B	512003	512003A	512003B	71211302	71220002
71220102	71220402	71220602	71220702	71220902	71221002
71223202	71223402	71223602	71223802	71226602	71227702
71270102	71270202	71270302	71270402	71271002	71273702
71427002	71470302	71923002	7258	7526	7526B
7526C	7528B	7528C	7531	7531B	7543
7543A	7543B	7545	7545A	7552	7552A
7552AB	7552B	7552C	7552D	7554	7554A
7560	7560A	7560B	7560C	7565A	7565AB
7565B	7565C	7565D	7565DE	7565E	7566
7566A	7566AB	7566B	7566C	7567	7567A
7567AB	7567B	7567C	7567D	7567DE	7567E
7568	7568A	7568AB	7568B	7568C	7569A
7569ABC	7569B	7569C	7569D	7570	7570A

VALEO(DUCELLIER)

512001	513001	513002	513003	513004	513005
513008	513009	513010	513011	515002	515003
515005	515006	515007	515008	515009	515010
515013	515014	515015	515016	7522	7527
7529	7532	7533	7534	7535	7548
7550	7553	7555	7556	7571	7572
7575	7576	7577	7578	7579	7580
7581	7582	7585	7586	7590	7591
7596	7597				

VALEO(MOTOROLA)

510-064	510-079	510-157	9AL2572K	9AL2582K	9AL2679K
---------	---------	---------	----------	----------	----------

VALEO(PARIS RHONE)

A13N100	A13N102	A13N135	A13R115	A13R141	A13R152
A13R154	A13R157	A13R170	A13R171	A13R177	A13R178
A13R180	A13R184	A13R186	A13R198	A13R219	A13R223
A13R265	A14R29	A14R47			

VR-DU511

*Voltage Set Point:14.5V

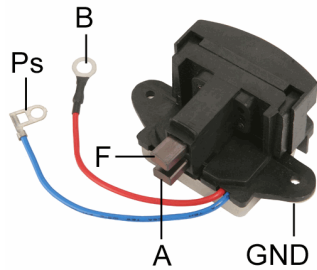

Replaces

CITROEN :

95546007

DELCO REMY (LUCAS) :

21220353

LUCAS :

21220253 UCB206 UCB207

RENAULT :

7701024524 7701027713 7701030069

VALEO :

NB982

VALEO(DUCELLIER) :

511006 511008 511010 511022 511024 581255

581256 690587 690645 690686 691097 691253

691292 691428 691468

Unit no.

VALEO(DUCELLIER)

512008 512010 514011 514012 516006 516008

516009 516015 516016 516017 516020 516023

516024 516025 516026 516029 516030 516033

516034 516042 516045 516047 516048 516049

516058 516062

VR-DU512

*Voltage Set Point:14.5V

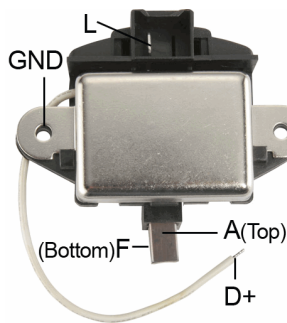

Replaces

LUCAS :

21220371 UCB227

MAGNETI MARELLI :

940038047

PEUGEOT :

5761.48 5761.49 5761.61

VALEO :

NB926 NB928

VALEO(DUCELLIER) :

511015 511023 581257 582991 691112 691140

691183 691303 691338 691406 691458 691617

694548 694617

Unit no.

VALEO(DUCELLIER)

514005 514007CDE 514010BC 516032 516046 516053

516054 516055 516065

VR-DU513

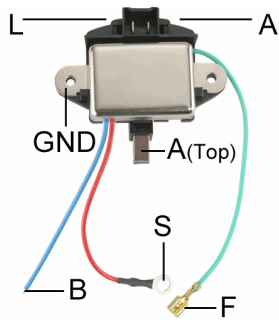

*For use on:Renault
*Voltage Set Point:14.5V

Replaces

LUCAS :
21220379 UCB235

VALEO :
NB987

VALEO(DUCELLIER) :
511018 691191

Unit no.

RENAULT
7700670275
VALEO(DUCELLIER)
516008 516035A 516035B

VR-DU514

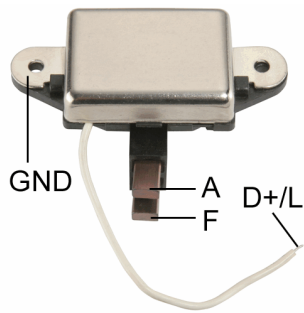

*Voltage Set Point:14.7V

Replaces

VALEO :
NB985 NB986

VALEO(DUCELLIER) :
511015 691146 691170

Unit no.

VALEO(DUCELLIER)
516002 516019 516027

VR-DU515

*Voltage Set Point:14.7V

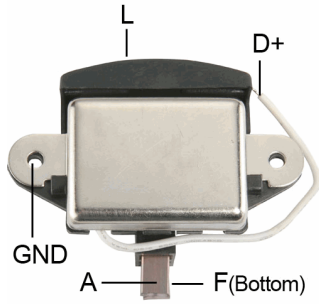

Replaces

DELCO REMY (LUCAS) :
21220383

VALEO :
NB988

VALEO(DUCELLIER) :
511015

Unit no.

VALEO(DUCELLIER)
516041

VR-VW002

*Voltage Set Point:14.5V

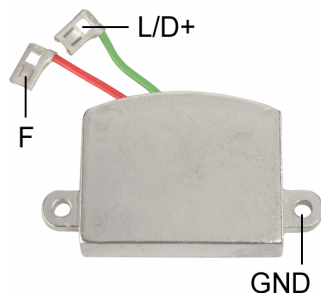

Replaces

AUDI/VW :

171903803 55903803 55903804

FORD :

6048270 77BB-10316AA

LUCAS :

21029141 21229047 21229114 21229491 UCB500

PEUGEOT :

5761.39

VALEO :

592838 505001 505003 505005 505008 505009

505010 505011 505016 505018 505025 505028

505029 505030 505070 505078 505082 505083

505099 505180 NB163 NB165 NB166 NB191

NB193 NB413 NB417 NB431 NB456 NB466

VALEO(MOTOROLA) :

9RC2003 9RC2006 9RC7002 9RC7003 9RC7004 9RC7008

9RC7020 9RC7022 9RC7028 9RC7031 9RC7036 9RC7038

9RC7059 9RC7063 9RC7065 9RC7071 9RC7073 9RC7093

Unit no.

VALEO(MOTOROLA)

10-763	10-764	10-765	10-766	10-767	10-769
10-772	2523160	2523207	2940357	2940361	2940782
510-015	510-031	510-054	510-123	510-146	510-148
510-205	510-246	510-270	510-283	510-296	510-330
510-357	510-401	510-412	510-453	510-455	510-465
9AR2500K	9AR2506K	9AR2512P	9AR2520K	9AR2533P	9AR2539K
9AR2561K	9AR2638P	9AR2672P	9AR2694P	9AR2755P	9AR2759
9AR2805G	9AR2830L	9AR2838L	9AR2862	9AR2867L	9AR2897L
9AR2938T	9AR2990P	9AR2992P	9AR5001K	9AR5037L	9AR5039L
9ASR5043P	9BB2KA2A01	9BB2KB2A02	9BB2KB2A06	9BB2KB2A07	9BE2KA2A14
9BE2KB2A06	9BE2KB2A07	9BE2KB2A08	9BE2KB2A15	9BE2KC2A32	9BE2KD2A40
9BE2NA2A21	9BE2NB2A38	9BE2NE2A41	9FB2KA2A03	9FB2KB2A04	9FB2KB2A06
9FB2LD2A07	9FD2KB2A12	9FD2KC2A35	9FD2LD2A07	9FD2LE2A13	9FD2NA2A19
9FD2NC2A24	9FD2ND2A34	9FD2ND2A42	9FD2NE2A33	9FD2NE2A43	9FD2NF2A37
9FD2NF2A44	9FD2NG2A39	9FD2PA2A16	9FE2KA2A11	9FE2KA2A18	9FE2KB2A07
9FE2KB2A08	9FE2LD2A07	9FE2LD2A08	9FF2LD2A10	9GD2NA2A25	

VR-VW003

*Voltage Set Point:14.5V

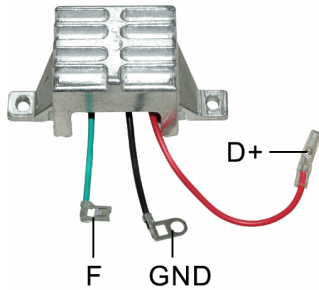

Replaces

AUDI/VW :
36903803

FORD :
6073340 80BB-10316AA

LUCAS :
21229048 21229142 UCB501

VALEO :
505019 505020 505031 505032 505069 505072
NB188 NB414 NB468

VALEO(MOTOROLA) :
9RC7024 9RC7025 9RC7041 9RC7042 9RC7056 9RC7057

Unit no.

VALEO(MOTOROLA)

9AR2683G	9AR2687G	9AR2697D	9AR2698F	9AR2699G	9AR2700G
9AR2701D	9AR2702	9AR2703F	9AR2704F	9AR2705G	9AR2706G
9AR2707G	9AR2708G	9AR2718G	9AR2719G	9AR2726G	9AR2727G
9AR2729G	9AR2750G	9AR2751G	9AR2792G	9AR2814G	9AR2819G
9AR2820G	9AR2821G	9AR2839G	9AR2840D	9AR2841D	9AR2842G
9AR2843G	9AR2847F	9AR2876D	9AR2877F	9AR2878G	9AR2880K
9AR2882F	9AR2883G	9AR2889F	9AR2890G	9AR2895F	9AR2895F02
9AR2895F03	9AR2913D	9AR2914D	9AR2915F	9AR2916F	9AR2917G
9AR2918G	9AR2929G	9AR2960F	9AR2978F		

VR-VW004

*Voltage Set Point:14.5V

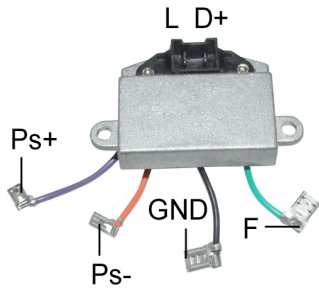

Replaces

LUCAS :
21229165 UCB503

RENAULT :
7701024064

VALEO :
2522098 505026 505103 NB464

VALEO(MOTOROLA) :
9RC7030 9RC7101

Unit no.

VALEO

433430	433437	433453	436318	510147	510151
510152	510172	510302	510349	510367	9AR2659K
9AR2660K	9AR2675K	9AR2676K	9AR2695K	9AR2760K	9AR2778K
9AR2869K	9AR2933P	9AR2934K	9AR2934P	9AR2935P	9AR2936P
9AR2945K	9AR2948K	9AR2950P	9AR2996P	9AR5023P	9AR5042P

VR-VW005N

*Voltage Set Point:14.5V

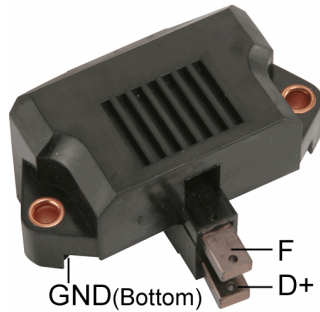

Replaces

AUDI/VW :

026903015E 036903803A 037903803 049903803H

CHRYSLER :

2940030

LUCAS :

21229199 UCB506

MAGNETI MARELLI :

940038151

VALEO :

2519124	2521766	2522098	2522939	2523198	2541484
2940328	2941121	505100	505105	592781	592806
592888	592952	592963	A519124A	A521760A	A940318A
NB492	YV1923	YV49	YV4904	2519490	2940022
YV99	YV9911	2521760	2940318		

VALEO(DUCELLIER) :

505-100 505-105 592806 592989

VALEO(MOTOROLA) :

2522939	2940022	2940030	2940305	2940305A	2940318
9RC2018	9RC2021	9RC7088	9RC7104		

Unit no.

AUDI/VW

026903015E

MITSUBISHI MOTORS

9AR2973L

VALEO

026903015EV	026903015EX	026903015EY	049903119L	068903031KV	068903031KX
068903171	2518017	2521682	2541114	2541115	2541187
2541221	2541222	2541233	2541234	2541235	2541236
2541301	2541305	2541334	2541372	2541396	2541402
2541428	2541429	2541430	2541431	2541432	2541438
2541479	2541480	2541481	2541497	2541498	2541499
2541682	2940301	436112	436114	436117	436132
436134	436147	436191	436192	436193	436220
436294	436296	436330	436331	436332	436333
436334	436368	436369	436370	436398	436399
436400	436404	436405	A13E03	A13E04	A13E05
A13E06	A13E07	A13E08	A13E09	A13E10	A13E11
A13E12	A13E13	A13E19	A13E21	A13E22	A13E23
A13E24	A13E25	A13E26	A13E47	A13E48	

VALEO(MOTOROLA)

2940302	2940304	2940305	2940306	2940307	2940308
2940309	2940310	2940311	2940363	2940365	2940367
2940369	2940371	2940373	2940375	2940409	9AL2977
9AR2970K	9AR2971G	9AR2972G	9AR2973L	9AR2974L	9AR2975L
9AR2976K	9AR2977L	9AR5044K	9AR5046G	9AR5081K	9AR5082G
9AR5083G	9AR5084L	9AR5085L	9AR5086L	9AR5087K	9AR5088L
9AR5089G	9AR5090L	9AR5099	9AR5099L	9AR5100G	9AR5101K

VALEO(PARIS RHONE)

A14V01	A14V02	A14V03	A14V04	A14V05	A14V07
A14V08	A14V09	A14V10	A14V11	A14V12	A14V13
A14V14	A14V15	A14V16	A14V17	A14V18	A14V19

VR-VW005NH

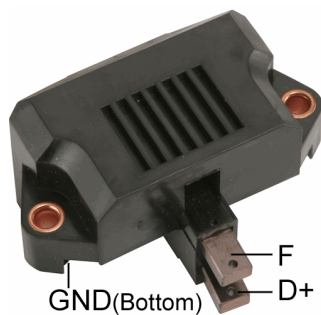

*Heavy Duty for Max.140A Alternators.
*Voltage Set Point:14.5V

VR-VW006

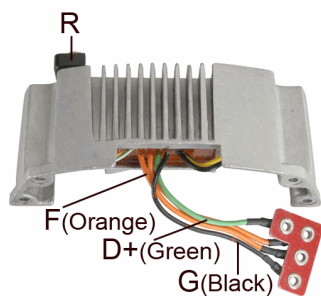

*24V
*Adjustable Voltage
*Voltage Set Point:26.6V~30.0V

Replaces

VALEO(MOTOROLA) :
105246 8RL3011

Unit no.

VALEO(MOTOROLA)
10-298 8SC3014U

VR-VW007

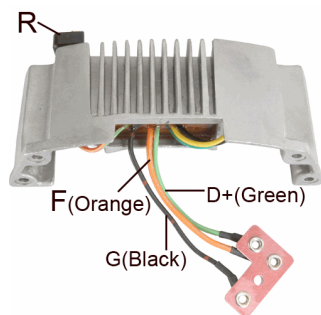

*24V
*Adjustable Voltage
*Voltage Set Point:26.6V~30.0V

Replaces

VALEO(MOTOROLA) :
105229 8RL3007

Unit no.

VALEO(MOTOROLA)
10-258

VR-VW009

*Voltage Set Point:14.5V

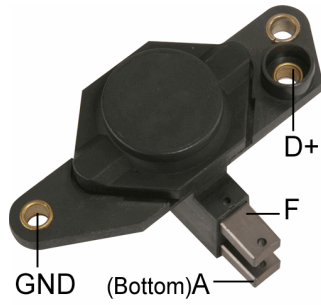

Replaces

MERCEDES-BENZ :

1500255

VALEO :

2518044 592792 YV0913H

VALEO(MOTOROLA) :

2541141

Unit no.

MERCEDES-BENZ

008-154-6708 008-154-8702 008-154-8902

VALEO

2518044 2518046 2541297

VALEO(PARIS RHONE)

A13V02 A13V05 A13V07

VR-VW010

*Voltage Set Point:14.7V

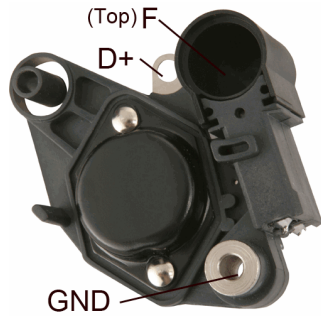

Replaces

AUDI/VW :

028903803F 078903803A 078903803B

LUCAS :

2131049 UCB245

MAGNETI MARELLI :

940038186 943356220 943356220010

MERCEDES-BENZ :

21549106

PEUGEOT :

5761.87 5761.9

VALEO :

YM1949	YM3953	YM6555	YM6952	YM6955	YM9980
YV1928	YV1966T	YV9966T	2545472	593131	593139
593301	593312	593326	593350	2521335	2541392
2541404	2541433	2541493	2541666	2541667	2541682
2541721	2541800	592791	592797	592800	592801
592910	592911	593133	9RC6065	A808422A	NC985
YM1950	YV1965T	YV1969T	YV3970H		

VALEO(MOTOROLA) :

9RC6065 9RC2054

VOLKSWAGEN :

028903803F 078903803A 078903803B

VR-VW010

Unit no.

AUDI/VW

030903023AA	030903023EV	030903023EX	030903023FV	030903023FX	030903023GV
030903023GX	030903023QV	030903023QX	050903017H		

DAIMLER-BENZ

0091545902	91545902				
------------	----------	--	--	--	--

VALEO

2541246	2541299	2541321	2541348	2541355	2541357
2541360	2541361	2541362	2541391	2541405	2541408
2541411	2541412	2541415	2541416	2541417	2541418
2541419	2541420	2541447	2541455	2541457	2541458
2541459	2541461	2541475	2541486	2541494	2541611
2541612	2541617	2541626	2541644	2541646	2541655
2541658	2541665	2541676	2541680	2541683	2541694
2541698	2541699	2541703	2541711	2541719	2541724
2541726	2541731	2541733	2541734	2541736	2541738
2541739	2541740	2541741	2541747	2541758	2541759
2541760	2541763	2541764	2541765	2541767	2541775
2541776	2541784	2541785	2541786	2541793	2541794
2541799	2541801	2541802	2541812	2541814	2541815
2541816	2541817	2541818	2541821	436258	436260
436261	436336	436338	436339	436340	436345
436346	436361	436364	436379	436380	436385
436386	436388	436389	A11VI15	A11VI19	A11VI20
A11VI32	A11VI33	A11VI35	A11VI36	A11VI37	A11VI38
A11VI39	A11VI40	A11VI42	A11VI43	A11VI44	A11VI45
A11VI46	A11VI47	A11VI48	A11VI49	A11VI50	A11VI51
A11VI52	A11VI53	A11VI55	A11VI56	A11VI57	A11VI58
A11VI60	A11VI62	A11VI63	A11VI65	A11VI66	A13VI100
A13VI101	A13VI102	A13VI108	A13VI109	A13VI113	A13VI114
A13VI121	A13VI123	A13VI124	A13VI125	A13VI126	A13VI132
A13VI137	A13VI138	A13VI140	A13VI142	A13VI27	A13VI33
A13VI36	A13VI37	A13VI38	A13VI39	A13VI40	A13VI41
A13VI42	A13VI43	A13VI44	A13VI51	A13VI53	A13VI58
A13VI59	A13VI60	A13VI63	A13VI68	A13VI71	A13VI74
A13VI75	A13VI76	A13VI79	A13VI81	A13VI83	A13VI84
A13VI85	A13VI86	A13VI87	A13VI88	A13VI94	A13VI95
A13VI96	A13VI99	A14VI10	A14VI11	A14VI13	A14VI14
VALEO(PARIS RHONE)					
A11VI10	A11VI11	A11VI17	A11VI18	A11VI22	A11VI23
A11VI24	A11VI25	A11VI91	A13VI10	A13VI48	A13VI49
A13VI54	A13VI67	A13VI69	A13VI70		

VR-PR002H

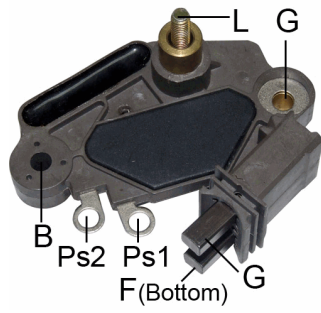

- *Soft Start
- *2.5 sec. LRC
- *Short Circuit Protection
- *Voltage Set Point:14.6V

Replaces

VALEO :

593290 593310 593349

VALEO(PARIS RHONE) :

YM1600

Unit no.

VALEO(PARIS RHONE)

A11VI165	A11VI184	A11VI209	A11VI212	A11VI216	A11VI217
A11VI218	A11VI224	A11VI225	A11VI227	A11VI254	A11VI79
A11VI85	A11VI92	A11VI93	A11VI96	A13VI136	A13VI157
A13VI163					

VR-PR003H

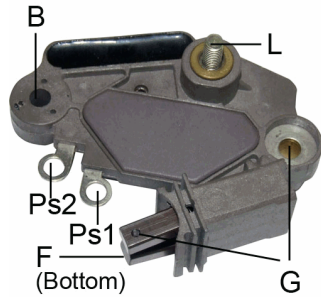

- *Soft Start
- *8.5 sec. LRC
- *Short Circuit Protection
- *Voltage Set Point:14.6V

Replaces

VALEO :

593319

VALEO(PARIS RHONE) :

YM1919P1

Unit no.

VALEO(PARIS RHONE)

A13VI178	A13VI202	A13VI237	A13VI257
----------	----------	----------	----------

VR-PR1000H

*Same as VR-PR1652H except with New Housing
 *Voltage Set Point: 14.5V

L IG

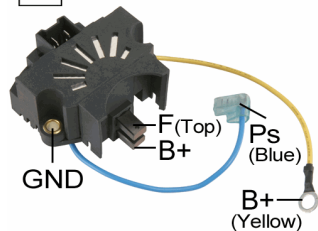

Replaces

ISKRA :

11-125-113 AER1521

LUCAS :

21225345 UCB218 UCB223 NCB218

MAGNETI MARELLI :

940038162

RENAULT :

7701028400 7701029095 7701031737 7701033171 7701348589

SEV MARCHAL :

71490602 72590602 72590702 72591202

VALEO :

2590558	590558	2541137	590679	YH1655	YV1655
2590588	300668	182046	2590588	300668	300795
300806	300868	300894	300901	92860	92927
NC189	NC192				

VALEO(PARIS RHONE) :

YH1649	YH1652	YH1654	YL122	YL129	YL149
YL152	YL154	YL155	YV1652	YV1654	YM1652

Unit no.

SEV MARCHAL

71651902 71652402 71652602

VALEO(PARIS RHONE)

A13N104	A13N106	A13N107	A13N108	A13N110	A13N113
A13N116	A13N117	A13N119	A13N12	A13N120	A13N121
A13N124	A13N126	A13N13	A13N137	A13N139	A13N14
A13N15	A13N17	A13N18	A13N19	A13N20	A13N27
A13N29	A13N30	A13N31	A13N49	A13N50	A13N53
A13N6	A13N64	A13N65	A13N81	A13N85	A13N86
A13N87	A13N88	A13N89	A13N90	A13N97	A13R218
A13R221	A13R222	A13R228	A13R230	A13R231	A13R242
A13R243	A13R247	A13R255	A13R256	A13R258	A13R260
A13R270	A14E25T	A14E45	A14N102	A14N113	A14N117
A14N12	A14N13	A14N14	A14N50	A14N51	A14N53
A14N54	A14N56	A14N60	A14N62	A14N63	A14N64
A14N65	A14N69	A14N70	A14N76	A14N77	A14N85
A14N86	A14N88	A14N89	A14N95	A14N96	A14N97
A14N99					

VR-PR1060H

- *Soft Start
- *8.5 sec. LRC
- *Short Circuit Protection
- *Voltage Set Point:14.2V

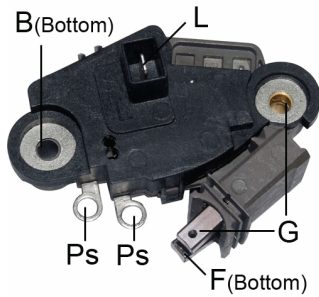

Replaces

VALEO :

593305 593318

VALEO(PARIS RHONE) :

YM10607P YM1606P1 YV1060P

Unit no.

VALEO(PARIS RHONE)

A13VI151

VR-PR120

- *Voltage Set Point:14.5V

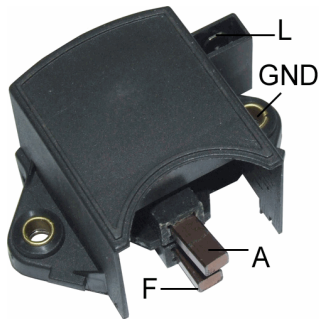

Replaces

MAGNETI MARELLI :

940038164

VALEO :

92856 92913 97729 NC168 NC170 NC173

VALEO(PARIS RHONE) :

YL120 YL121 YL127

Unit no.

VALEO

2094803 2097853 2098190 2098621 2098624 2099199

2099427 2099751 2100060

VALEO(PARIS RHONE)

A1235 A12R30 A12R31 A12R32 A12R37 A12R41

A13R192 A13R214 A14R10T A14R14T A14R26 A14R28

A14R35 A14R41

VR-PR123

*Voltage Set Point:14.5V

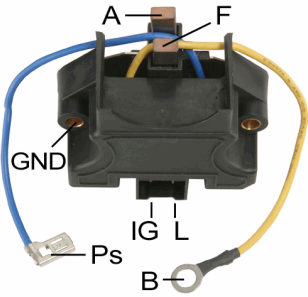

Replaces

LUCAS :
21225423

VALEO :
300669 92867

VALEO(PARIS RHONE) :
YL123 YL123B YL134 YL143

Unit no.

VALEO(PARIS RHONE)
2098216 2098482 2102159 2102160 A12M11 A12M16
A12M17 A12M9

VR-PR124

*To be replaced by VR-PR2000H
*Voltage Set Point:14.5V

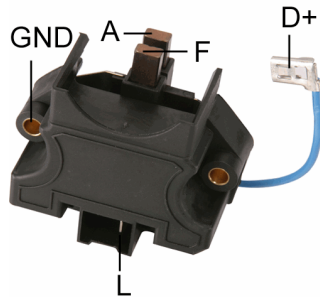

VR-PR126

*Voltage Set Point:14.5V

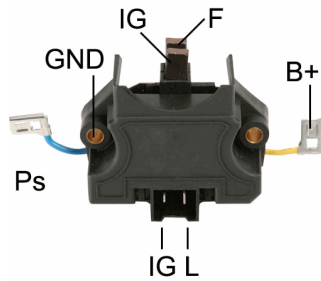

Replaces

DELCO REMY (LUCAS) :
21225422

RENAULT :
7701030814

VALEO :

182005	182011	2590558	300725	300883	590660
92937	92982	92990	A518052A	NC175	NC176
NC191	YV1654				

VALEO(PARIS RHONE) :

YH1639	YH2602	YH2605	YH2606	YL126	YL138
YL139	YL151	YV126	YV1652	YV2605	

Unit no.

VALEO(PARIS RHONE)

A13N10	A13N43	A13N69	A13N76	A13N92	A14N10
A14N22	A14N35	A14N36	A14N37	A14N55	A14N59
A14N73	A14N75	A14N76	A14N83	A14N84	A14N9
A14N95					

VR-PR127B

*24V
*Voltage Set Point:28.3V

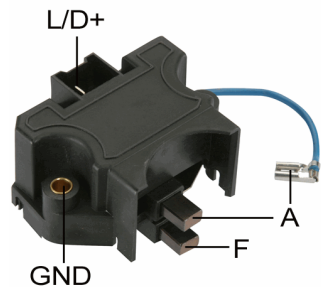

Replaces

PEUGEOT :
5761.51

VALEO :
92955 NC692

VALEO(PARIS RHONE) :
ZL127

Unit no.

VALEO(PARIS RHONE)

A12R35T	A14R341T	A14R34T	A14R541T	A14R542T	A14R543T
A14R54T					

VR-PR128

*Voltage Set Point:14.5V

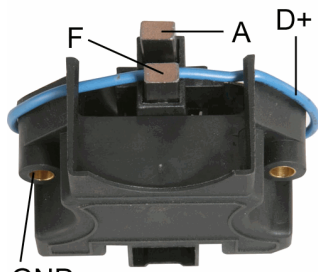

Replaces

VALEO :

182007 182013 300663 300685 92991

VALEO(PARIS RHONE) :

YH1903 YH1928 YL128 YL137 YL145 YV1903

Unit no.

VALEO(PARIS RHONE)

A13N165 A13N21T A13N26 A13N34 A13N52 A13N80
A13N93

VR-PR128B

*24V
*Voltage Set Point:28.3V

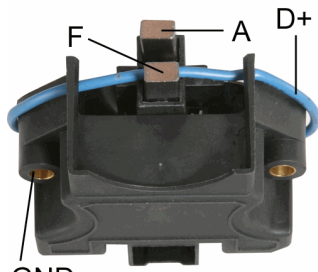

Replaces

LUCAS :

UCB237

VALEO :

ZL126 ZL128 ZV3928 590640 92901 92962

A541184A NC171 092962Y

VALEO(PARIS RHONE) :

ZL126 ZL128 ZV3928

Unit no.

VALEO(PARIS RHONE)

A13N11 A13N174 A13N190 A13N22T A13N4T A13N5T
A14N104 A14N133 A14N135 A14N138 A14N39 A14R33

VR-PR130

*Voltage Set Point:14.5V

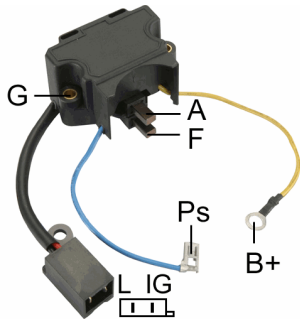

Replaces

SEV MARCHAL :
72591502

VALEO :
300667 300675 300676 92918 92930 92933

VALEO(PARIS RHONE) :
YL130 YL131 YL136 YL140 YL141 YL142

Unit no.

VALEO(PARIS RHONE)
A12R38 A12R46 A14N1 A14N2 A14R35 A14R37
A14R42 A14R46

VR-PR132B

*24V
*Voltage Set Point:28.3V

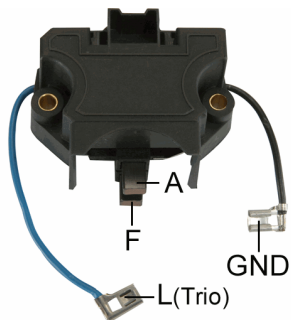

Replaces

VALEO :
182008 2590537

VALEO(PARIS RHONE) :
YV3932 ZL132 ZL134 ZV3932

Unit no.

VALEO
2101823 2181757 2181758 2181759 2181760 2541660
436352
VALEO(PARIS RHONE)
A13N140T A13N141T A13N142T A13N256 A13N51 A14N114T

VR-PR135

*Voltage Set Point:14.5V

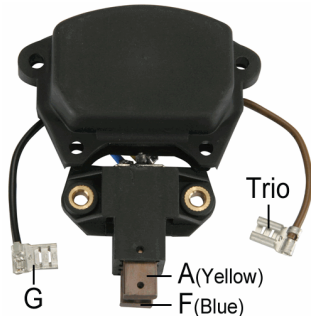

Replaces

LUCAS :
UCB243

VALEO :
YV77 YV7735 2590512 300692 300741 92966
NC362 NC927 590512

VALEO(PARIS RHONE) :
YL135 YL146 YL147

Unit no.

VALEO(PARIS RHONE)
A13N28M A14N48M A14N66M

VR-PR135B

*24V
*Voltage Set Point:28.3V

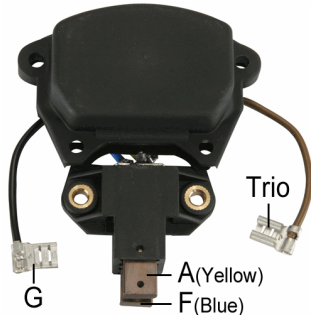

Replaces

LUCAS :
21225372 UCB239

VALEO :
300744 NC184

VALEO(PARIS RHONE) :
ZL129

Unit no.

VALEO(PARIS RHONE)
A13N143M A13N152M A13N36M A13N56M A13N59M A14N112M
A14N115M A14N116M A14N206M

VR-PR135BA

*24V
 *Adjustable Voltage
 *Voltage Set Point:25.0~30.0V

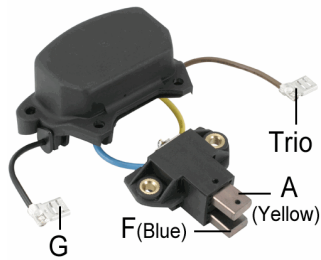

Replaces

LUCAS :
 21225372 UCB239

VALEO :
 300744 NC184

VALEO(PARIS RHONE) :
 ZL129

Unit no.

VALEO(PARIS RHONE)

A13N33M	A13N36M	A13N59M	A14N122M	A14N137M	A14N141M
A14N30M	A14N47M	A14N81M			

VR-PR1424H

*Voltage Set Point:14.6V
 *w/o Choke

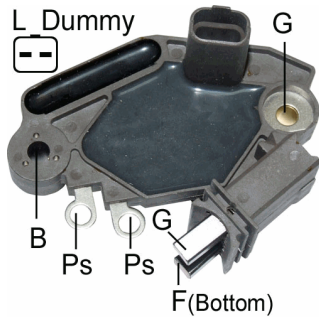

VR-PR152A

*To be Replaced by VR-PR1652/PR-1652H
 *Voltage Set Point:14.5V

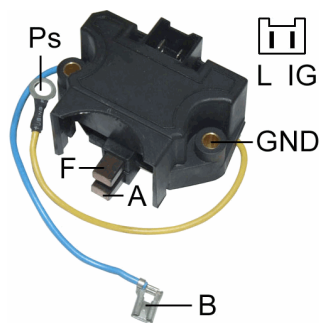

VR-PR1601H

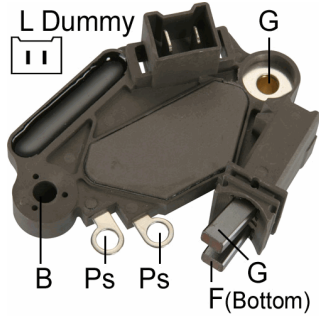

- *Soft Start
- *2.5 sec. LRC
- *Short Circuit Protection
- *Voltage Set Point:14.6V

Replaces

VALEO :
593141

VALEO(PARIS RHONE) :
YM1601T

Unit no.

VALEO(PARIS RHONE)

A11VI54	A11VI76	A11VI77	A13VI117	A13VI118	A13VI122
A13VI139	A13VI148	A13VI149			

VR-PR1620H

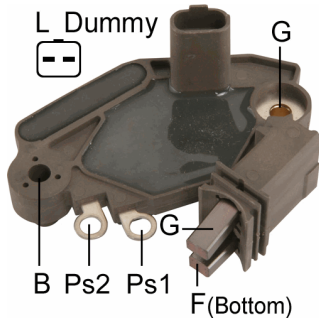

- *W/ Choke
- *Voltage Set Point:14.6V

Replaces

VALEO :
593316
YM1622P

593338
YM1662P

593411

9RC7108

YM1424P1

YM1620

Unit no.

VALEO(PARIS RHONE)

2541946	2541947	2541953	2541954	2541980	2542252
2542275	2542302	2542322	2542325	2542326	2542327
2542354	2542464	2542480	2542495	2542551	2542552
2542553	2542645	2542691	436712	436742	436748
436750	437112	437119	437168	437183	437196
437197	437200	437306	437323	437347	437353
437408	439215	439230	439266	439280	439281
439284	439302	A11VI110	A11VI111	A11VI87	A11VI88
A11VI94	A11VI98	A13VI188	A13VI195	A13VI235	A13VI238
A13VI249	A13VI251	A13VI252	A13VI253	A13VI259	A13VI285
A13VI289	A13VI290	A13VI291	A13VI297	A13VI300	

VR-PR1667

*Voltage Set Point:14.7V

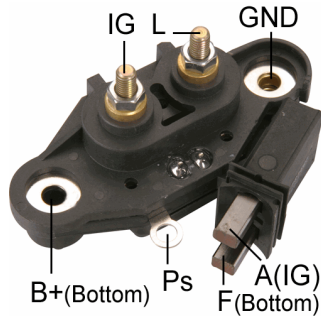

Replaces

VALEO :

2541406	2541496	592793	9RC2055	9RC2062	A808239A
NC987	YV1867H				

VALEO(PARIS RHONE) :

YV1667H

Unit no.

VALEO(PARIS RHONE)

A11VI28	A11VI31	A13VI21	A13VI11	A13VI14	A13VI16
A13VI17	A13VI20	A13VI23	A13VI25	A13VI28	A13VI31
A13VI32	A13VI34	A13VI35	A13VI45	A13VI47	

VR-PR1668

*Voltage Set Point:14.7V

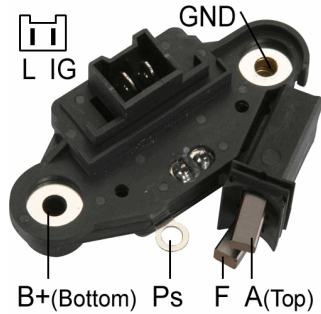

Replaces

VALEO :

2541407	592802	YV1668H	YV1868H
---------	--------	---------	---------

Unit no.

VALEO(PARIS RHONE)

A13VI13	A13VI28	A13VI30	A13VI152
---------	---------	---------	----------

VR-PR1669

*Voltage Set Point:14.7V

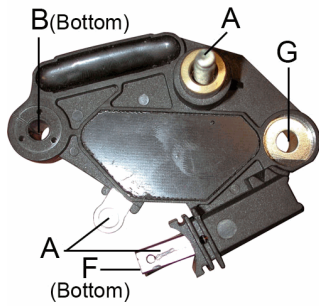

Replaces

VALEO :

2541715 2541715B 2808323 5931138 NF076 RTM151A

VALEO(MOTOROLA) :

9RC6074

VALEO(PARIS RHONE) :

YM6951

Unit no.

VALEO

2541678 2541679 A13V172 A13V173

VR-PR1671

*Voltage Set Point:14.2V

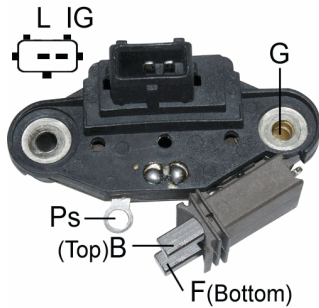

Replaces

VALEO :

593132 593140

VALEO(PARIS RHONE) :

YV10673H YV3670

Unit no.

VALEO(PARIS RHONE)

A13VI97

VR-PR1926

*Voltage Set Point:14.7V

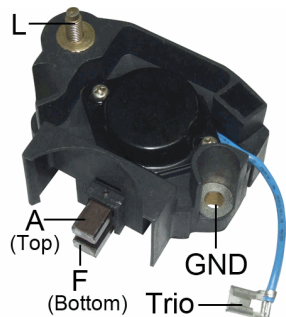

Replaces

CITROEN :
9405761798

VALEO :
2541192 2541193 590688 9RC2047 YV1926

VALEO(PARIS RHONE) :
YV1926T

Unit no.

VALEO(PARIS RHONE)
A13N184 A14N139 A14N172

VR-PR1935

*Soft Start
*8.5 sec. LRC
*Short Circuit Protection
*Voltage Set Point:14.8V

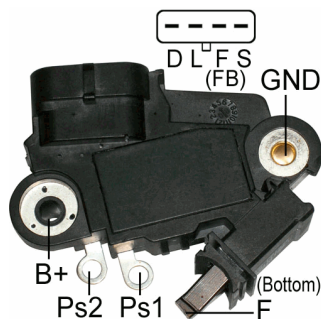

Replaces

VALEO :
593342 2541935B

Unit no.

GM
10246634
VALEO
2542445A A14VI21 A14VI39

VR-PR2000H

*Voltage Set Point:14.5V

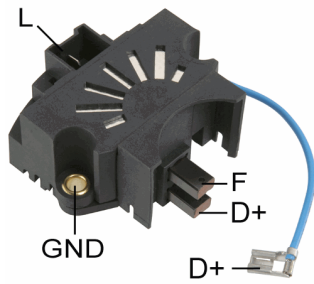

Replaces

LUCAS :

21225183 UCB220

MAGNETI MARELLI :

940038161

PEUGEOT :

5761.56

SEV MARCHAL :

72590902

VALEO :

590538	590704	592803	593191	182120	2590538
2590542	300820	300830	300884	92897	92902
92940	92981	NC178	NC187	NC313	

VALEO(PARIS RHONE) :

YH1925	YH1933	YH2701	YH2925	YL124	YL125
YL132	YL133	YV1924	YV2925	YV1933	

VOLVO :

3343913

Unit no.

VALEO(PARIS RHONE)

A12R22	A12R33	A12R52	A13N32	A13N39	A13N41
A13R267	A13R268	A14N16	A14N23	A14N78	A14N80
A14N88	A14N91				

VR-PR2206

*Soft Start
 *3 Sec. LRC
 *Short Circuit Protection
 *Voltage Set Point:14.6V

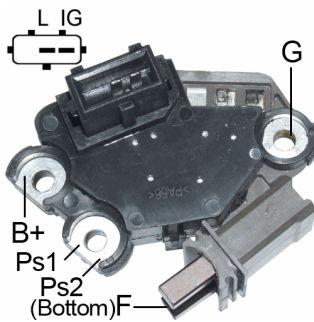

Replaces

VALEO :

2543327B

Unit no.

BOSCH

0-986-045-031

VALEO

2542812A	2542826A	2542812	2542826
----------	----------	---------	---------

VR-PR2222

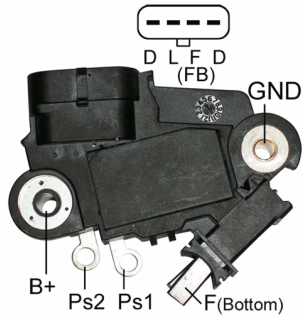

- *Soft Start
- *8.5 sec. LRC
- *Short Circuit Protection
- *Voltage Set Point:14.8V

Replaces

VALEO :
2542222B

VR-PR2288

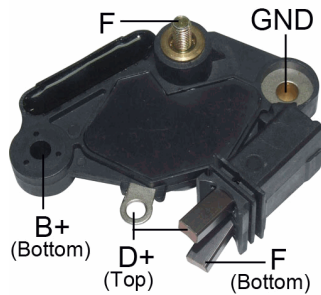

- *Voltage Set Point:14.7V

Replaces

VALEO :
2542288 593375
VALEO(PARIS RHONE) :
YM6956

VR-PR2292H

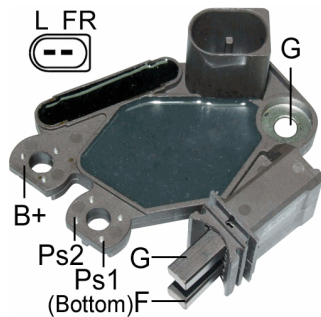

- *B-Circuit
- *Soft Start
- *2.5 sec. LRC
- *Short Circuit Protection
- *Voltage Set Point:14.7V

Replaces

AUDI :
06B903803 06B903803A 06B903803B 078903803C
VALEO :
593455 593941 593371 593455 593480 593522
593813 593940 593941 593942
VALEO(PARIS RHONE) :
YM1626F YM1672

Unit no.

VALEO
2542234
VALEO(PARIS RHONE)
SG12B010 SG12B011 SG12B015 SG12B018 SG12B042 SG12B047
SG9B010 SG9B011 SG9B013 SG9B015 SG9B018 SG9B019
SG9B023 SG9B024 SG9B042

VR-PR2293

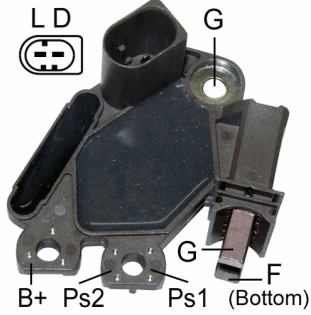

- *B-Circuit
- *Soft Start
- *2.5 sec. LRC
- *Short Circuit Protection
- *Plug is different from VR-PR2292H
- *Voltage Set Point:14.6V

Replaces

VALEO :
593943

Unit no.

VALEO
SG12B024

VR-PR2299H

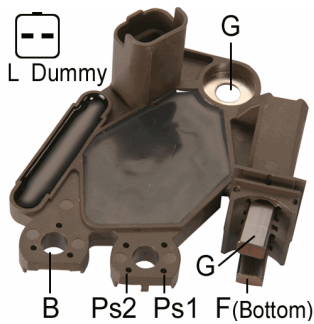

- *Voltage Set Point:14.6V

Replaces

VALEO :
2542299 593384 593396 YM1636P1

Unit no.

VALEO

2542270 2542466

VALEO(PARIS RHONE)

SG10B010 SG10B011 SG10B016 SG10B019 SG10B020 SG10B031
SG10B032 SG12B017 SG12B030

VR-PR2339

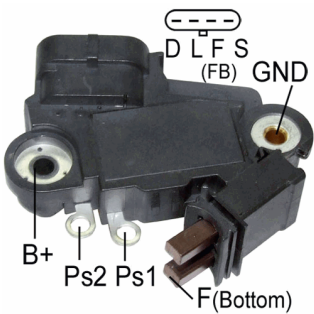

- *Soft Start
- *8.5 sec. LRC
- *Short Circuit Protection
- *Voltage Set Point:14.8V

Replaces

VALEO :
2542339B

Unit no.

VALEO

A14VI63 SA14VI63

VR-PR3389

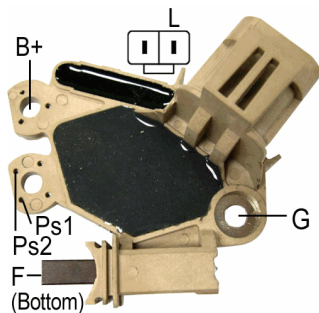

- *B-Circuit
- *Inactive Lamp
- *Soft Start
- *8 sec. LRC
- *Short Circuit Protection
- *Voltage Set Point:14.6V

Replaces

VALEO :

593389	593818	2542213	2548923
--------	--------	---------	---------

Unit no.

HYUNDAI
37300-37250
VALEO
439295

Used On

HYUNDAI

Sonata	2.5L	2000-2001
Sonata	2.7L	2002-

KIA

Optima	2.5L	2001-
Optima	2.7L	2002-2004

VR-PR3430

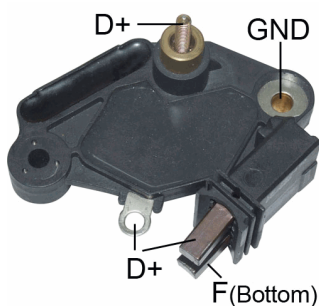

- *24V
- *Voltage Set Point:28.3V

Replaces

VALEO :

2542419	593430
---------	--------

VALEO(PARIS RHONE) :
ZV3963T

Unit no.

VALEO

2542433	2542479	2542493
---------	---------	---------

VALEO(PARIS RHONE)

HD90S013	HD90S014	HD90S015
----------	----------	----------

VR-PR3529

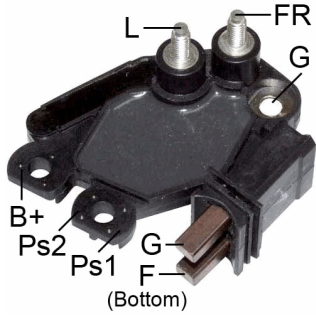

- *Soft Start
- *2.5 sec LRC
- *Short Circuit Protection
- *Self Exciting
- *Voltage Set Point:14.6V

Replaces

VALEO :
593529

Unit no.

VALEO
2542485A 9642879480

VR-PR3534

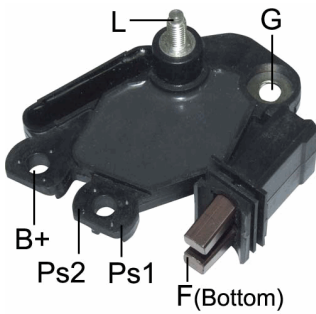

- *Soft Start
- *2.5 sec LRC
- *Short Circuit Protection
- *Voltage Set Point:14.6V

Replaces

VALEO :
593477 593505 593534 YR 6604 YR66P 2542934

Unit no.

VALEO
2542414A 2542489 2542489A 2542564 SG10B041 SG15S021
SG15S022 SG7S014 SG7S024 SG8B020 TG15C015

VR-PR3617H

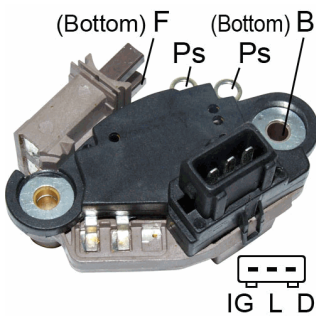

- *Voltage Set Point:14.5V

Replaces

VALEO :
2542204 593333 2542209B 593347 593391

VALEO(PARIS RHONE) :
YM2618P1 YM3617PIC

Unit no.

VALEO(PARIS RHONE)
A13V1150 A13V1160

VR-PR3729A

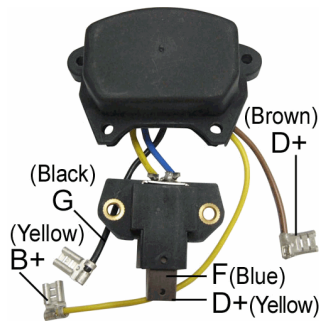

*24V
 *Voltage Set Point: 27.8V+/- 0.3V
 *Adjustable Voltage

Replaces

MAGNETI MARELLI :

940038173

VALEO :

590536

VALEO(PARIS RHONE) :

A14N100M	A14N119M	A14N122M	A14N137	A14N141M	ZV 3729
ZY 3729					

Unit no.

VALEO

2102052	2180619	2180620	2181991	2541168	2541199
A14N100M	A14N119M	A14N122M	A14N137	A14N137M	A14N141M
A14N200	A14N200M	A14N30M	A14N33M	A14N81M	

VR-PR3960

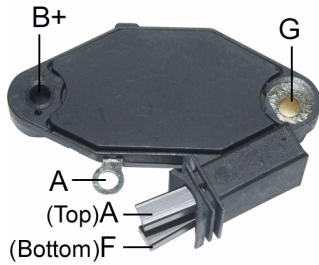

*24V
 *Voltage Set Point:28.3V

Replaces

VALEO :

593260

VALEO(PARIS RHONE) :

ZV3960H

Unit no.

VALEO(PARIS RHONE)

A14V119

VR-PR5023

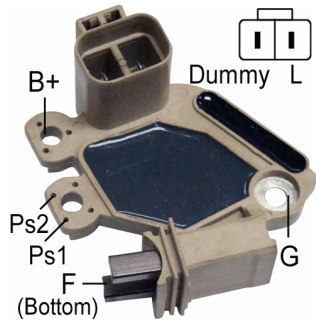

- *B-Circuit
- *Inactive Lamp
- *Short Circuit Protection
- *Voltage Set Point:14.5V

Replaces

HYUNDAI :
37370-22650

Unit no.

HYUNDAI
37300-22650
VALEO
A0002655023 2655023

Used On

HYUNDAI

Accent	1.6L	2003-2007
Elantra	2.0L	2005-2006
Tiburon	2.0L	2004-2007
Tucson	2.0L	2005-2007

KIA

Rio	1.6L	2006-2007
Spectra	2.0L	2004-2007
Sportage	2.0L	2005-2007

VR-PR6366

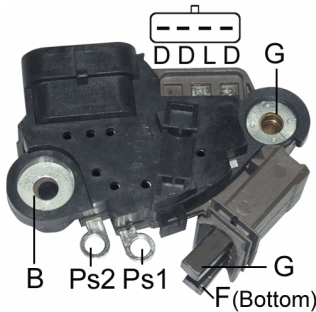

- *Voltage Set Point:14.6V
- *Soft Start
- *8.5 Second LRC
- *Short Circuit Protected

Replaces

VALEO :
2546366C 2546493C

Unit no.

DELCO
10295859
VALEO
439218
VALEO(PARIS RHONE)
A13VI147 A13VI194

VR-PR6603H

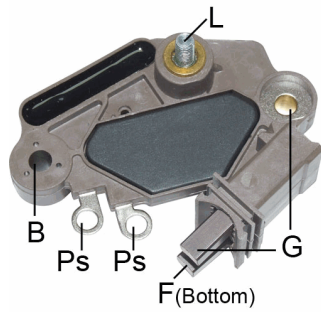

- *Soft Start
- *2.5 sec. LRC
- *Short Circuit Protected
- *Voltage Set Point:14.6V

Replaces

VALEO :
593284

Unit no.

VALEO
2542500

VR-PR7736

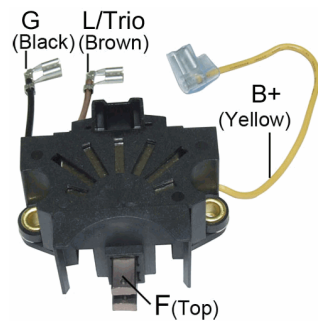

- *Voltage Set Point:14.5V

Replaces

VALEO :
593135

VALEO(PARIS RHONE) :
YV7736

Unit no.

VALEO(PARIS RHONE)
A13N234 A13N259 A13N285

VR-H2005-10S

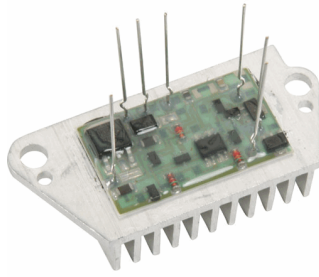

*Repairs:
 *VR-H2005-10
 *Voltage Set Point: 14.4V

VR-H2005-15S

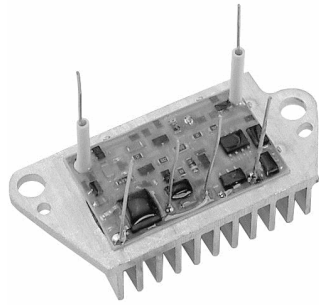

*Repairs:
 *VR-H2005-15H
 *VR-H2005-24
 *Voltage Set Point: 14.4V

VR-H2005-16AS

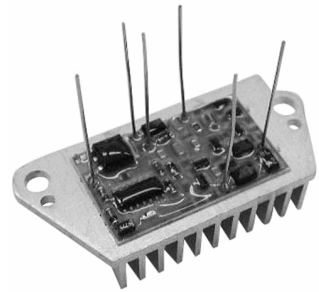

*Repairs:
 *VR-H2005-16A
 *Voltage Set Point: 14.6V

VR-H2005-17AS

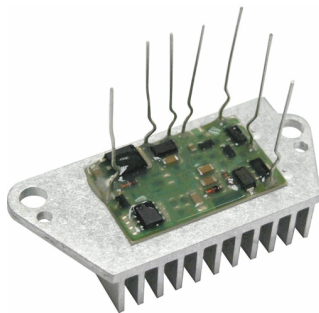

*Repairs:
 *VR-H2005-17A
 *VR-H2005-30A
 *VR-H2005-36A
 *Voltage Set Point: 14.6V

VR-H2005-18AS

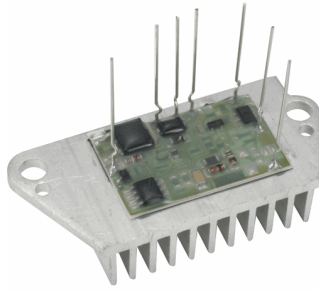

*Repairs:
 *VR-H2005-18A
 *VR-H2005-63A
 *VR-H2005-31A
 *Voltage Set Point:14.6V

VR-H2005-19AS

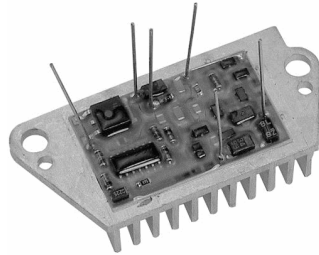

*Repairs:
 *VR-H2005-19A
 *Voltage Set Point:14.6V

VR-H2005-22S

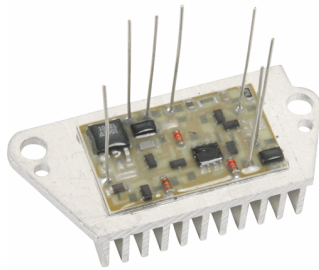

*Repairs:
 *VR-H2005-22
 *VR-H2005-40
 *Voltage Set Point:14.6V

VR-H2005-23AS

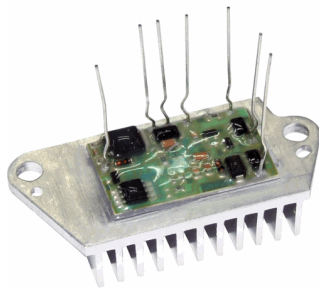

*Repairs:
 *VR-H2005-23A
 *Voltage Set Point:14.6V

VR-H2005-25S

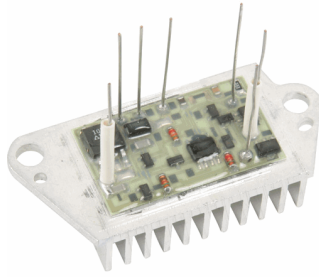

*Repairs:
*VR-H2005-25
*Voltage Set Point:14.4V

VR-H2005-26AS

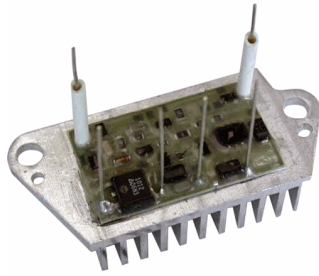

*Repairs:
*VR-H2005-26A
*VR-H2005-39
*Voltage Set Point:14.6V

VR-H2005-33AS

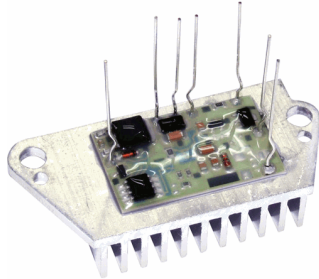

*Repairs:
*VR-H2005-33A
*VR-H2005-46A
*Voltage Set Point:14.6V

VR-H2005-34S



*Repairs:
*VR-H2005-34
*Voltage Set Point:14.6V

VR-H2005-3S

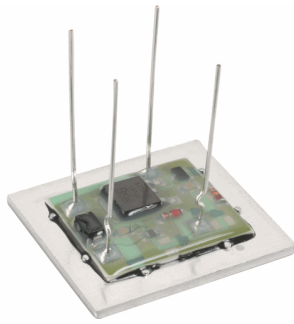

*Repairs:
*VR-H2005-3
*VR-H2005-28
*VR-H2005-29
*Voltage Set Point:14.5V

VR-H2005-48AS

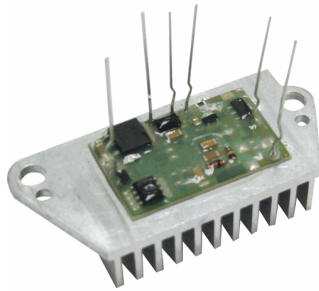

*Repairs:
*VR-H2005-48A
*Voltage Set Point:14.6V

VR-H2005-4AS

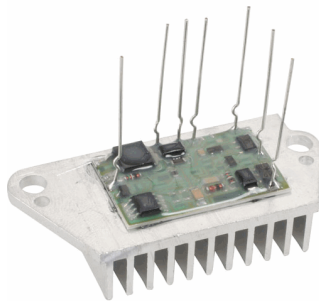

*Repairs:
*VR-H2005-4A
*VR-H2005-45A
*Voltage Set Point:14.6V

VR-H2005-58S

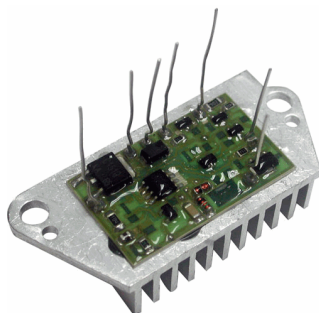

*Repairs:
*VR-H2005-58
*Voltage Set Point: 28.3V

VR-H2005-5S

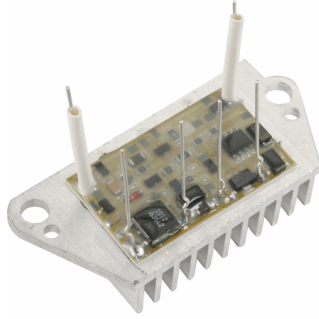

- *Repairs:
- *VR-H2005-5H
- *VR-H2005-14H
- *VR-H2005-16
- *VR-H2005-47
- *Voltage Set Point:14.4V

VR-H2005-62AS

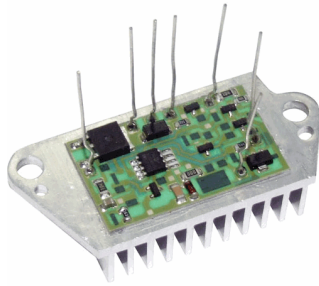

- *Repairs:
- *VR-H2005-62A
- *Voltage Set Point:14.6V

VR-H2005-6S

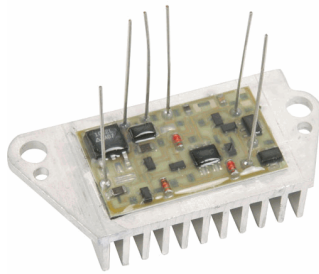

- *Repairs:
- *VR-H2005-6H
- *Voltage Set Point:14.4V

VR-H2005-7S

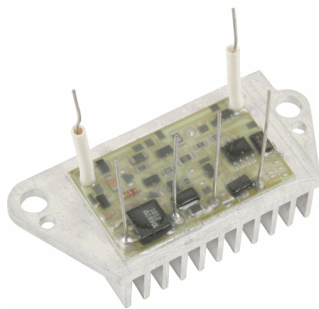

- *Repairs:
- *VR-H2005-7

VR-H2005-8S

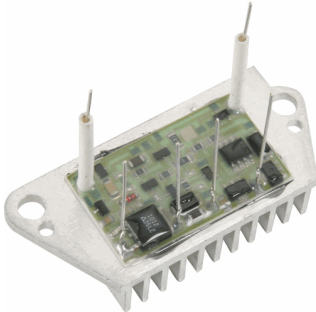

*Repairs:
*VR-H2005-8
*VR-H2005-19
Voltage Set Point: 14.4V

VR-H2005-9AS

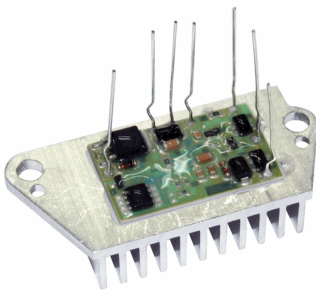

*Repairs:
*VR-H2005-9A
*Voltage Set Point:14.6V

VR-H2000-10S

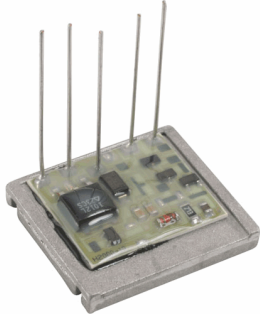

*Repairs:
*VR-H2000-4H
*VR-H2000-10
*VR-H2000-21
*Voltage Set Point:14.5V

VR-H2000-13S

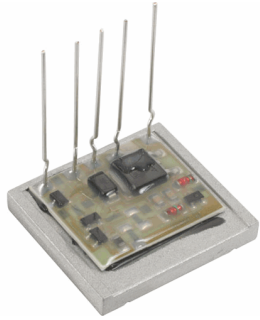

*Repairs:
*VR-H2000-6H
*VR-H2000-13
*Voltage Set Point:14.5V

VR-H2000-14S

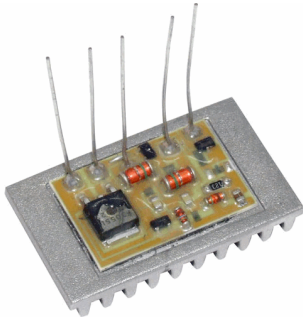

*Repairs:
*VR-H2000-14
*Voltage Set Point:14.5V

VR-H2000-15S

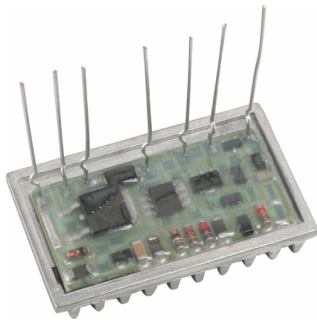

*Repairs:
*VR-H2000-15
*Voltage Set Point:14.5V

VR-H2000-17S

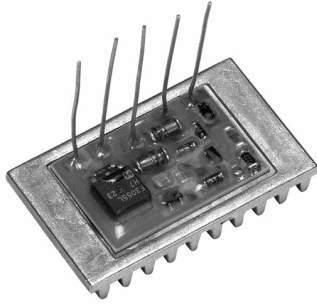

*Repairs:
*VR-H2000-17
*Voltage Set Point:14.5V

VR-H2000-18S

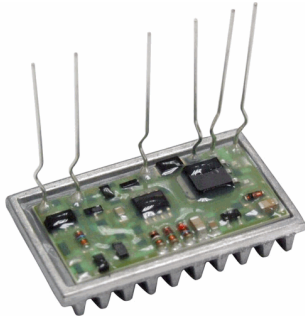

*VR-H2000-18
*Voltage Set Point:14.5V

VR-H2000-19S

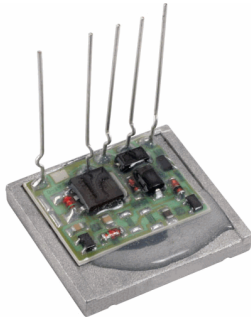

*Repairs:
*VR-H2000-7H
*VR-H2000-11
*VR-H2000-19
*VR-H2000-20
*Voltage Set Point:14.5V

VR-H2000-23S



*Repairs:
*VR-H2000-23
*VR-H2000-16
*Voltage Set Point:14.5V

VR-H2000-24S

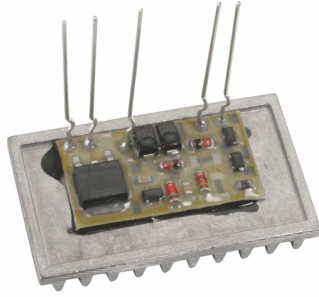

*Repairs:
 *VR-H2000-24
 *Voltage Set Point:14.5V

VR-H2000-26S

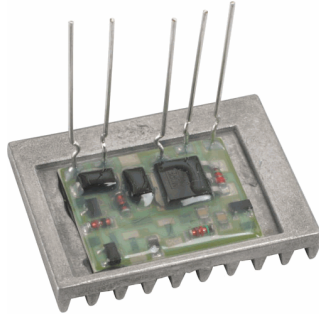

*Repairs:
 *VR-H2000-26
 *Voltage Set Point:14.5V

VR-H2000-28S

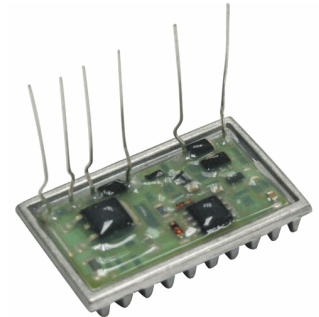

*Repairs:
 *VR-H2000-27
 *VR-H2000-28
 *Voltage Set Point:14.5V

VR-H2000-38S

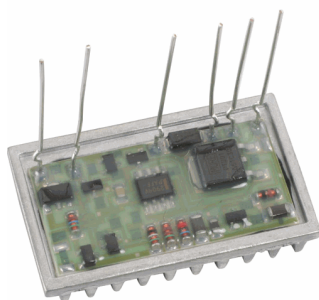

*Repairs:
 *VR-H2000-38
 *Voltage Set Point:14.5V
 *W/o Overvoltage/Undervoltage indication
 *W/o Short Circuit Protection

VR-H2000-41S

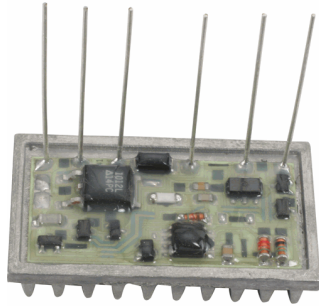

*Repairs:
*VR-H2000-41

VR-H2000-44S

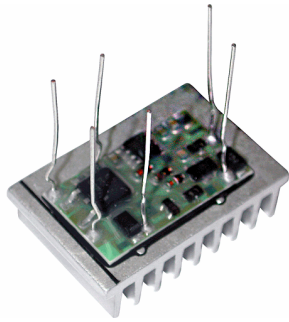

*Repairs:
*VR-H2000-44
*Voltage Set Point:14.5V

VR-H2000-46S

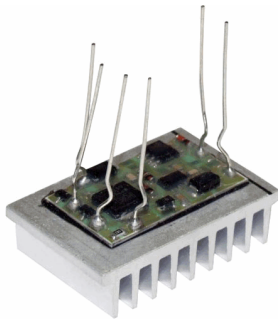

*Repairs:
*VR-H2000-46
*Voltage Set Point:14.5V

VR-H2000-48S

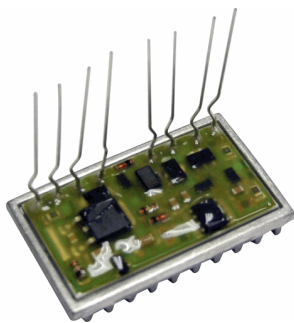

*Repairs:
*VR-H2000-48

VR-H2000-51S

*Repairs:
*VR-H2000-51

VR-H2000-52S

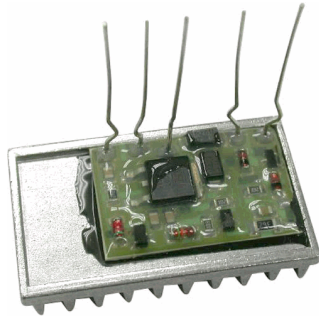

*Repairs:
*VR-H2000-52
*Voltage Set Point:14.3V

VR-H2000-55BS

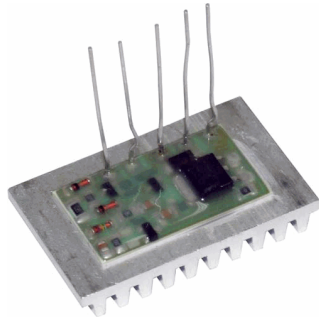

*Repairs:
*VR-H2000-55
*Voltage Set Point:28.5V

VR-H2000-57S

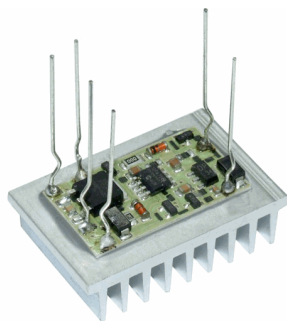

*Repairs:
*VR-H2000-57
*Voltage Set Point:14.3V

VR-H2000-5S

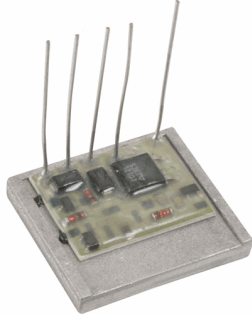

*Repairs:
*VR-H2000-5H

VR-H2000-9S

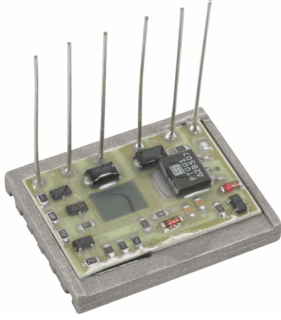

*Repairs:
*VR-H2000-9
*VR-H2000-12
*Voltage Set Point:14.5V

VR-H2009-86S

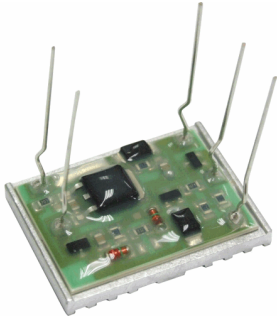

*Repairs:
*VR-H2009-86
*Voltage Set Point:14.2V

VR-MD07S

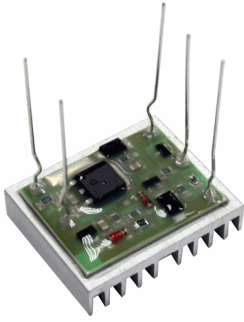

*Repairs:
*VR-MD07
*Voltage Set Point:14.4V

VR-H2009-105S

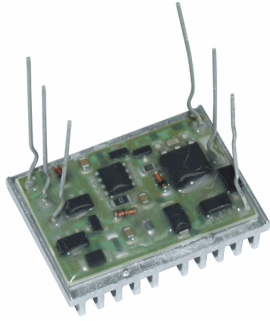

*Repairs:
VR-H2009-105

VR-H2009-108S

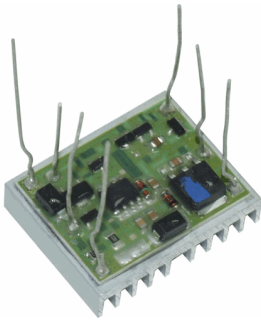

*Repairs:
VR-H2009-108 with A/M Housing

VR-H2009-10AS

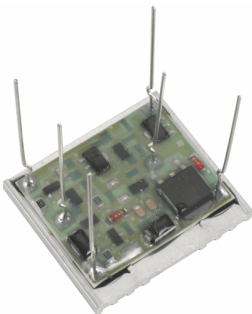

*Repairs:
*VR-H2009-10N
*VR-H2009-24
*VR-H2009-25
*VR-H2009-26
*VR-H2009-33
*VR-H2009-35
*Voltage Set Point: 14.6V

VR-H2009-112S

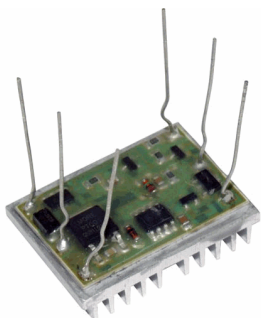

*Repairs:
*VR-H2009-112
*Voltage Set Point: 14.5V

VR-H2009-115S

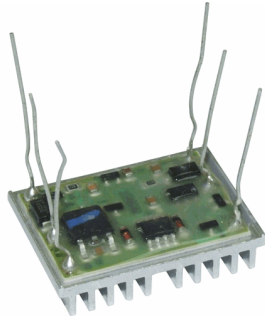

*Repairs:
VR-H2009-108 with OE Housing

VR-H2009-11S

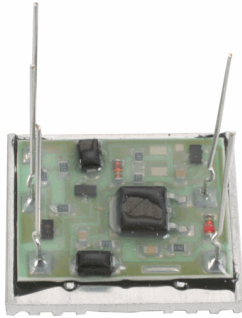

*Repairs:
*VR-H2009-11H
*VR-H2009-41
*Voltage Set Point:14.6V

VR-H2009-14NS

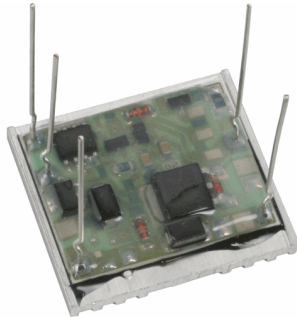

*Repairs:
*VR-H2009-14N
*Voltage Set Point:14.6V

VR-H2009-159S

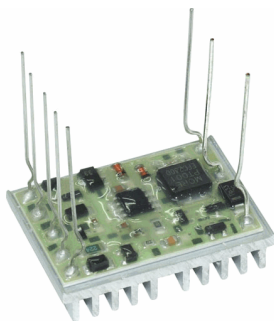

*Repairs:
VR-H2009-159

VR-H2009-15S

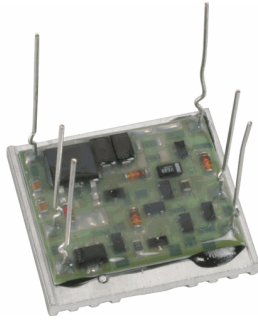

*Repairs:
*VR-H2009-15
*Voltage Set Point:14.5V

VR-H2009-20S

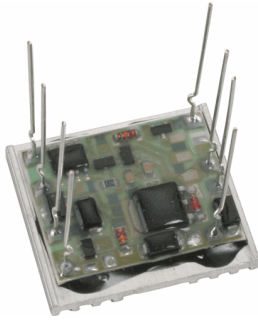

*Repairs:
*VR-H2009-20
*Voltage Set Point:14.6V

VR-H2009-38S

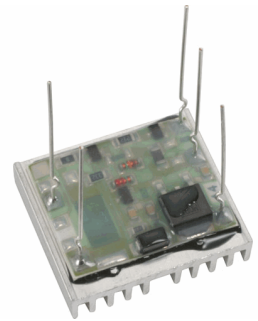

*Repairs:
*VR-H2009-38
*Voltage Set Point:14.5V

VR-H2009-40S

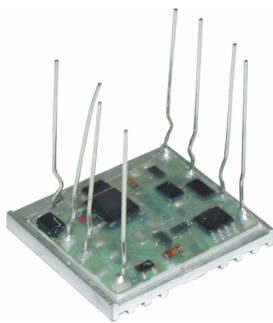

*Repairs:
*VR-H2009-40
*Voltage Set Point:14.6V

VR-H2009-43S

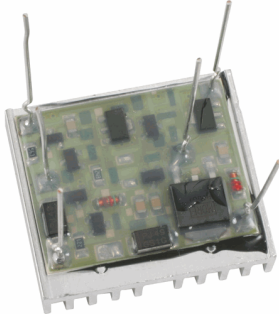

*Repairs:
*VR-H2009-22
*VR-H2009-37
*VR-H2009-43
*Voltage Set Point:14.5V

VR-H2009-44S

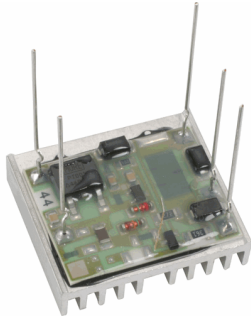

*Repairs:
*VR-H2009-44
*Voltage Set Point:14.7V

VR-H2009-45S

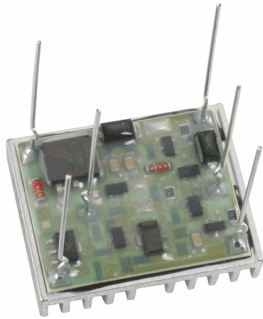

*Repairs:
*VR-H2009-45
*Voltage Set Point:14.5V

VR-H2009-49S

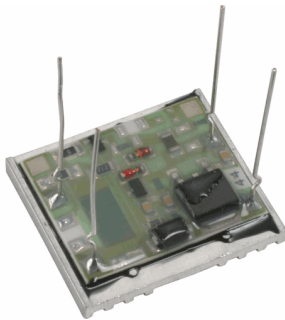

*Repairs:
*VR-H2009-49
*Voltage Set Point:14.6V

VR-H2009-4S



*Repairs:
*VR-H2009-4H
*VR-H2009-9H
*VR-H2009-13H
*Voltage Set Point: 14.7V

VR-H2009-50S

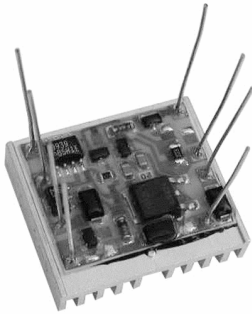

*VR-H2009-50
*Voltage Set Point: 14.5V

VR-H2009-58S

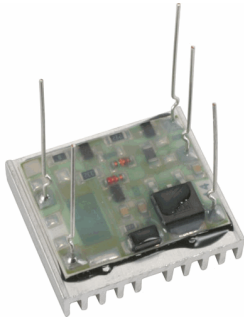

*Repairs:
*VR-H2009-58
*Voltage Set Point: 14.6V

VR-H2009-59S



*Repairs:
*VR-H2009-59
*Voltage Set Point: 14.6V

VR-H2009-5S



*Repairs:
*VR-H2009-5H
*VR-H2009-31
*VR-H2009-6H
*VR-H2009-28
*Voltage Set Point:14.6V

VR-H2009-64S

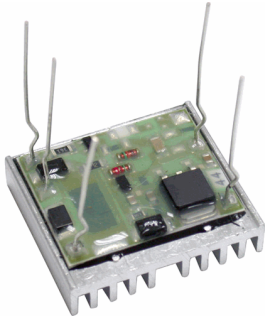

*Repairs:
*VR-H2009-64
*Voltage Set Point:14.7V

VR-H2009-70AS

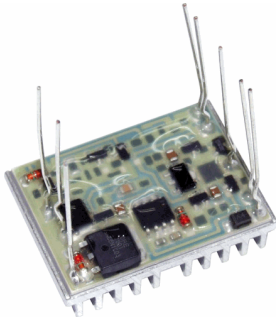

*Repairs:
*VR-H2009-70A
*Voltage Set Point:14.4V

VR-H2009-73S

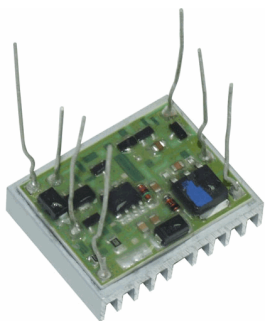

*Repairs:
*VR-H2009-73
*Voltage Set Point:14.4V

VR-H2009-7S

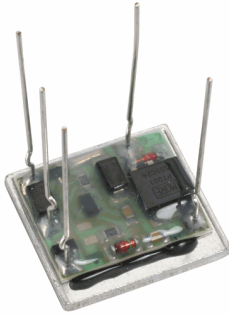

*Repairs:
 *VR-H2009-7H
 *VR-H2009-27
 *VR-H2009-8H
 *VR-H2009-23
 *Voltage Set Point:14.6V

VR-H2009-82S

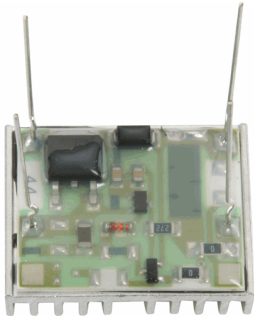

*Repairs:
 *VR-H2009-82
 *Voltage Set Point:14.7V

VR-H2009-83S

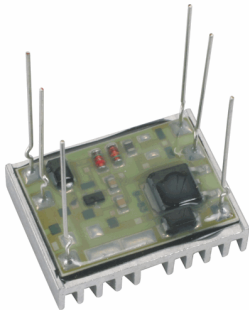

*Repairs:
 *VR-H2009-83
 *Voltage Set Point: 14.5V

VR-H2009-88S

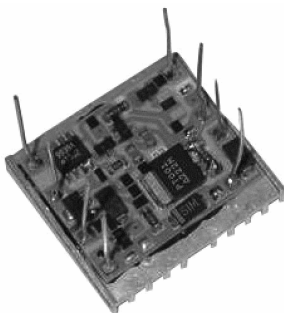

*Repairs:
 *VR-H2009-88
 *Voltage Set Point:14.5V
 *VR-H2009-88LS
 *Voltage Set Point:14.4V

VR-H2009-89S

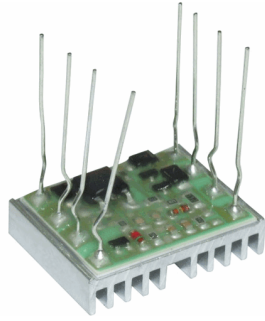

*Repairs:
*VR-H2009-89
*Voltage Set Point:14.3V

VR-H2009-94S

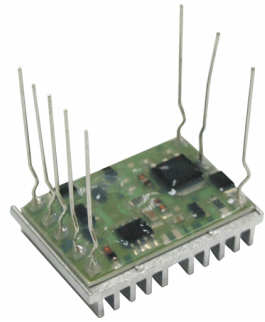

*Repair:
*VR-H2009-94
*Voltage Set Point:14.5V

VR-H2009-95S

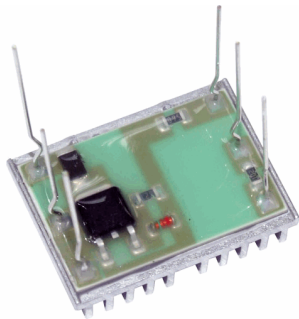

*Repairs:
*VR-H2009-95

VR-H2009-99S

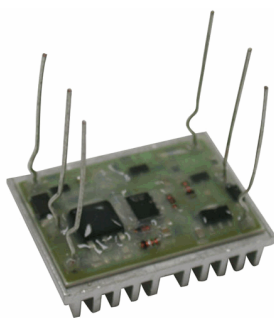

*Repairs:
*VR-H2009-99
*Voltage Set Point:14.5V

RB-01HA

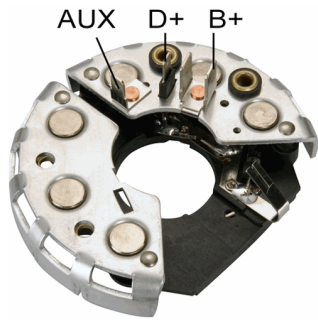

*114mm OD
*6-35 Amp Diodes

Replaces

ALFA ROMEO :

701655

AUDI/VW :

028903359A	036903359B	046903359B	049903359E	049903359F	052903371A
056903371A	059903371A	059903371B	28903359	49903359	52903371
56903371	59903359	59903511	9861217187	98612171877	

BMW :

12311354682

BOSCH :

1127011130	1127320312	1127011112	1127011113	1127011114	1127011115
1127011135	1127320101	1127320103	1127320105	1127320108	1127320119
1127320120	1127320125	1127320130	1127320134	1127320136	1127320138
1127320140	1127320143	1127320144	1127320145	1127320155	1127320157
1127320158	1127320160	1127320163	1127320174	1127320175	1127320176
1127320178	1127320181	1127320183	1127320185	1127320277	1127320307
1127320310	1127320311	1127320314	1127320322	1127320323	1127320329
1127320339	1127320341	1127320351	1127320355	1127320377	1127320378
1127320380	1127320381	1127320382	1127320392	1127320502	1127320512
1127320513	1127320528	1127320536	1127320554	1127320563	1127320572
1127320609	1127320610	1127320611	1127320612	1127320613	1127320630
1127320637	1127320641	1127320642	1127320644	1127320647	1127320649
1127320669	1127321312				

FIAT :

60749249	60755038	60777846	9936080	9950095	
----------	----------	----------	---------	---------	--

FORD :

1477517	6017534	6033077	6041730	6154904	71BB-10304BA
72GB-10304AA	74EB-10304AA	75BB-10304AA	75EB-10304AA		

IHC :

3078594R91

LUCAS :

UBB411

MERCEDES-BENZ :

1541316	1541416	1542016	1542916	1543216	1545016
1546416	1546816	1547616	1548116	1548216	

OPEL :

1205561

SAAB :

8518854	9955293
---------	---------

SEAT :

3980591	NG32033229
---------	------------

STEYR :

61000090743	61200090706
-------------	-------------

VALMET :

8353310743

RB-01HA

Unit no.

BOSCH

0-120-400-669	0-120-400-670	0-120-400-704	0-120-400-705	0-120-400-722	0-120-400-723
0-120-400-724	0-120-400-733	0-120-400-745	0-120-400-747	0-120-400-750	0-120-400-758
0-120-400-759	0-120-400-807	0-120-400-809	0-120-400-810	0-120-400-811	0-120-400-856
0-120-400-857	0-120-400-858	0-120-400-859	0-120-400-901	0-120-400-903	0-120-400-906
0-120-400-917	0-120-488-119	0-120-488-126	0-120-489-003	0-120-489-004	0-120-489-005
0-120-489-007	0-120-489-009	0-120-489-011	0-120-489-013	0-120-489-015	0-120-489-017
0-120-489-024	0-120-489-026	0-120-489-051	0-120-489-052	0-120-489-054	0-120-489-061
0-120-489-062	0-120-489-063	0-120-489-064	0-120-489-076	0-120-489-077	0-120-489-079
0-120-489-094	0-120-489-095	0-120-489-097	0-120-489-099	0-120-489-100	0-120-489-101
0-120-489-148	0-120-489-149	0-120-489-150	0-120-489-162	0-120-489-168	0-120-489-172
0-120-489-184	0-120-489-196	0-120-489-197	0-120-489-199	0-120-489-201	0-120-489-203
0-120-489-205	0-120-489-207	0-120-489-209	0-120-489-211	0-120-489-213	0-120-489-214
0-120-489-229	0-120-489-233	0-120-489-234	0-120-489-236	0-120-489-237	0-120-489-260
0-120-489-262	0-120-489-268	0-120-489-269	0-120-489-275	0-120-489-276	0-120-489-289
0-120-489-293	0-120-489-298	0-120-489-299	0-120-489-300	0-120-489-301	0-120-489-302
0-120-489-304	0-120-489-305	0-120-489-322	0-120-489-324	0-120-489-326	0-120-489-327
0-120-489-329	0-120-489-330	0-120-489-332	0-120-489-333	0-120-489-355	0-120-489-357
0-120-489-359	0-120-489-386	0-120-489-398	0-120-489-480	0-120-489-500	0-120-489-501
0-120-489-502	0-120-489-506	0-120-489-507	0-120-489-508	0-120-489-509	0-120-489-510
0-120-489-511	0-120-489-512	0-120-489-513	0-120-489-514	0-120-489-519	0-120-489-520
0-120-489-521	0-120-489-522	0-120-489-523	0-120-489-526	0-120-489-527	0-120-489-532
0-120-489-535	0-120-489-536	0-120-489-545	0-120-489-546	0-120-489-547	0-120-489-548
0-120-489-551	0-120-489-556	0-120-489-557	0-120-489-558	0-120-489-559	0-120-489-560
0-120-489-561	0-120-489-562	0-120-489-567	0-120-489-568	0-120-489-569	0-120-489-571
0-120-489-572	0-120-489-573	0-120-489-574	0-120-489-579	0-120-489-580	0-120-489-581
0-120-489-582	0-120-489-587	0-120-489-588	0-120-489-589	0-120-489-590	0-120-489-592
0-120-489-593	0-120-489-594	0-120-489-595	0-120-489-596	0-120-489-599	0-120-489-600
0-120-489-601	0-120-489-602	0-120-489-603	0-120-489-604	0-120-489-605	0-120-489-616
0-120-489-617	0-120-489-622	0-120-489-623	0-120-489-624	0-120-489-664	0-120-489-665
0-120-489-666	0-120-489-667	0-120-489-668	0-120-489-669	0-120-489-670	0-120-489-671
0-120-489-676	0-120-489-678	0-120-489-679	0-120-489-683	0-120-489-691	0-120-489-692
0-120-489-698	0-120-489-699	0-120-489-700	0-120-489-701	0-120-489-705	0-120-489-706
0-120-489-712	0-120-489-714	0-120-489-719	0-120-489-720	0-120-489-721	0-120-489-722
0-120-489-732	0-120-489-744	0-120-489-745	0-120-489-746	0-120-489-747	0-120-489-748
0-120-489-749	0-120-489-751	0-120-489-755	0-120-489-758	0-120-489-772	0-120-489-774
0-120-489-785	0-120-489-786	0-120-489-797	0-120-489-798	0-120-489-799	0-120-489-800
0-120-489-801	0-120-489-802	0-120-489-803	0-120-489-804	0-120-489-805	0-120-489-806
0-120-489-809	0-120-489-810	0-120-489-811	0-120-489-814	0-120-489-815	0-120-489-816
0-120-489-817	0-120-489-818	0-120-489-819	0-120-489-820	0-120-489-821	0-120-489-826
0-120-489-828	0-120-489-829	0-120-489-833	0-120-489-835	0-120-489-839	0-120-489-840
0-120-489-842	0-120-489-843	0-120-489-844	0-120-489-846	0-120-489-847	0-120-489-848
0-120-489-849	0-120-489-850	0-120-489-851	0-120-489-853	0-120-489-854	0-120-489-855
0-120-489-856	0-120-489-857	0-120-489-859	0-120-489-860	0-120-489-862	0-120-489-864
0-120-489-866	0-120-489-867	0-120-489-869	0-120-489-871	0-120-489-873	0-120-489-878
0-120-489-882	0-120-489-887	0-120-489-889	0-120-489-893	0-120-489-896	0-120-489-897
0-120-489-898	0-120-489-904	0-120-489-910	0-120-489-912	0-120-489-914	0-120-489-915
0-120-489-916	0-120-489-918	0-120-489-919	0-120-489-928	0-120-489-930	0-120-489-931
0-120-489-932	0-120-489-933	0-120-489-936	0-120-489-938	0-120-489-965	0-120-489-983
0-120-489-987	0-120-489-988	0-120-489-989	0-120-489-991	0-120-489-993	0-120-489-997
9-120-144-223	9-120-144-224	9-120-144-227	9-120-144-280	9-120-144-288	9-120-690-006
9-120-690-007	9-120-690-011	9-120-690-012	9-120-690-013	9-120-690-014	9-120-690-015

RB-02H

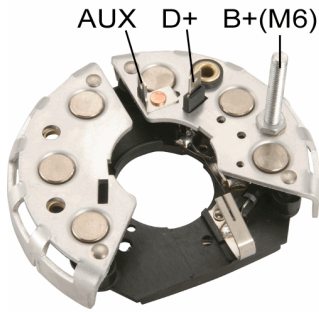

*114mm OD
*6-35 Amp Diodes

Replaces

ALFA ROMEO :

116.1005.060.04 116.1005.060.08 116.1005.060.13 119.1305.061.00 119.1305.061.21

AUDI/VW :

046903359A 056903359B 056903371B 46903359 56903359

BMW :

12311266720 12311268409 12311268415 12311279597 12311356060 12311358048
12311363097 12311706465

BOSCH :

1-127-011-117 1-127-011-118 1-127-011-119 1-127-011-120 1-127-011-121 1-127-011-123
1-127-011-124 1-127-011-125 1-127-011-128 1-127-011-138 1-127-011-140 1-127-320-110
1-127-320-117 1-127-320-128 1-127-320-139 1-127-320-148 1-127-320-149 1-127-320-150
1-127-320-170 1-127-320-171 1-127-320-184 1-127-320-187 1-127-320-188 1-127-320-189
1-127-320-190 1-127-320-195 1-127-320-196 1-127-320-197 1-127-320-300 1-127-320-301
1-127-320-303 1-127-320-304 1-127-320-305 1-127-320-306 1-127-320-308 1-127-320-309
1-127-320-313 1-127-320-318 1-127-320-320 1-127-320-325 1-127-320-326 1-127-320-336
1-127-320-346 1-127-320-347 1-127-320-383 1-127-320-384 1-127-320-385 1-127-320-500
1-127-320-501 1-127-320-508 1-127-320-509 1-127-320-510 1-127-320-511 1-127-320-529
1-127-320-573 1-127-320-574 1-127-320-575 1-127-320-583 1-127-320-618 1-127-320-619
1-127-320-620 1-127-320-622 1-127-320-623 1-127-320-624 1-127-320-633 1-127-320-634
1-127-320-645 1-127-320-646 1-127-320-650 1-127-320-657 1-127-320-681 1-127-320-686

CITROEN :

9405144528

DAF :

692060 694461

DELCO :

90140931 90272286

DELCO REMY (LUCAS) :

21221403

FIAT :

60725868 60736000 60754984 79022471 79031725 79078926
82327406 82335792 9927838 9934237 9934639 9936539
9936608 9937233 9937529 9939571 9941113 9960115

IHC :

3079133R91 3079133R92

IVECO :

79078926

KLOCKNER-HUMBOL-DEUTZ :

42487948 8121110

LANCIA :

82302915 82302916

MAGIRUS-DEUTZ :

8128110 8198792

OPEL :

1205449 1205550 1205551 1205553 1205555 1205557
1205558 1205559 1205562 1205565 1205569 90140010

PEUGEOT :

5744.52 5744.63 5744.67 5744.86 5744.88

SAAB :

8550113 8559825 8571903 8591083

SAME :

294391601

SEAT :

3980278 NG981025.29

TALBOT :

43278800

VOLVO :

1235288 1235577 1259577 1363914 243949 243950

RB-02H

692060

694461

Unit no.

BOSCH

0-120-400-471	0-120-400-472	0-120-400-740	0-120-400-743	0-120-400-771	0-120-400-772
0-120-400-782	0-120-400-783	0-120-400-827	0-120-400-828	0-120-400-831	0-120-400-832
0-120-400-833	0-120-400-834	0-120-400-838	0-120-400-839	0-120-400-840	0-120-400-841
0-120-400-849	0-120-400-850	0-120-400-852	0-120-400-853	0-120-400-854	0-120-400-855
0-120-400-889	0-120-400-890	0-120-400-910	0-120-400-911	0-120-400-912	0-120-400-913
0-120-400-914	0-120-400-915	0-120-400-921	0-120-400-922	0-120-400-926	0-120-400-927
0-120-400-928	0-120-400-932	0-120-400-933	0-120-400-938	0-120-400-939	0-120-488-353
0-120-488-028	0-120-488-030	0-120-488-036	0-120-488-102	0-120-488-103	0-120-488-123
0-120-488-129	0-120-488-139	0-120-488-141	0-120-488-151	0-120-488-152	0-120-488-211
0-120-488-221	0-120-488-235	0-120-488-252	0-120-488-253	0-120-488-254	0-120-488-274
0-120-488-275	0-120-488-276	0-120-488-287	0-120-489-021	0-120-489-029	0-120-489-031
0-120-489-037	0-120-489-039	0-120-489-040	0-120-489-042	0-120-489-044	0-120-489-046
0-120-489-058	0-120-489-066	0-120-489-125	0-120-489-127	0-120-489-129	0-120-489-131
0-120-489-135	0-120-489-137	0-120-489-139	0-120-489-143	0-120-489-153	0-120-489-154
0-120-489-155	0-120-489-167	0-120-489-171	0-120-489-182	0-120-489-188	0-120-489-191
0-120-489-212	0-120-489-217	0-120-489-218	0-120-489-219	0-120-489-220	0-120-489-254
0-120-489-273	0-120-489-279	0-120-489-285	0-120-489-297	0-120-489-307	0-120-489-319
0-120-489-339	0-120-489-348	0-120-489-350	0-120-489-351	0-120-489-358	0-120-489-394
0-120-489-400	0-120-489-401	0-120-489-411	0-120-489-412	0-120-489-413	0-120-489-422
0-120-489-450	0-120-489-455	0-120-489-487	0-120-489-498	0-120-489-533	0-120-489-534
0-120-489-537	0-120-489-538	0-120-489-543	0-120-489-544	0-120-489-549	0-120-489-550
0-120-489-575	0-120-489-576	0-120-489-577	0-120-489-578	0-120-489-585	0-120-489-586
0-120-489-606	0-120-489-607	0-120-489-608	0-120-489-609	0-120-489-610	0-120-489-611
0-120-489-614	0-120-489-615	0-120-489-626	0-120-489-627	0-120-489-628	0-120-489-629
0-120-489-630	0-120-489-631	0-120-489-632	0-120-489-633	0-120-489-634	0-120-489-635
0-120-489-636	0-120-489-637	0-120-489-638	0-120-489-639	0-120-489-640	0-120-489-644
0-120-489-645	0-120-489-646	0-120-489-647	0-120-489-648	0-120-489-649	0-120-489-650
0-120-489-651	0-120-489-652	0-120-489-654	0-120-489-655	0-120-489-656	0-120-489-657
0-120-489-659	0-120-489-660	0-120-489-661	0-120-489-668	0-120-489-682	0-120-489-686
0-120-489-688	0-120-489-709	0-120-489-716	0-120-489-718	0-120-489-735	0-120-489-737
0-120-489-739	0-120-489-766	0-120-489-767	0-120-489-768	0-120-489-769	0-120-489-781
0-120-489-783	0-120-489-793	0-120-489-794	0-120-489-795	0-120-489-796	0-120-489-812
0-120-489-813	0-120-489-824	0-120-489-836	0-120-489-837	0-120-489-875	0-120-489-877
0-120-489-879	0-120-489-880	0-120-489-882	0-120-489-904	0-120-489-906	0-120-489-943
0-120-489-948	0-120-489-949	0-120-489-951	0-120-489-952	0-120-489-955	0-983-032-950
0-986-030-480	0-986-030-500	0-986-030-650	0-986-030-670	0-986-030-671	0-986-030-680
0-986-030-690	0-986-030-700	0-986-030-710	0-986-030-730	0-986-030-731	0-986-030-800
0-986-030-810	0-986-030-830	0-986-030-850	0-986-030-870	0-986-030-900	0-986-030-910
0-986-030-940	0-986-030-990	0-986-031-050	0-986-031-070	0-986-031-090	0-986-031-091
0-986-031-150	0-986-031-200	0-986-031-210	0-986-031-240	0-986-031-280	0-986-031-340
0-986-031-360	0-986-031-361	0-986-031-460	0-986-033-250	0-986-033-330	0-986-033-910
0-986-034-120	0-986-034-490	0-986-034-640	0-986-034-730	0-986-034-931	0-986-035-630
0-986-035-690	0-986-036-480	0-986-036-750	9-120-144-073	9-120-144-086	9-120-144-087
9-120-144-101	9-120-144-105	9-120-144-109	9-120-144-121	9-120-144-122	9-120-144-124
9-120-144-205	9-120-144-207	9-120-144-216	9-120-144-217	9-120-144-234	9-120-144-236
9-120-144-237	9-120-144-255	9-120-144-266	9-120-690-020	9-120-690-021	9-120-690-025
9-120-690-111	9-120-690-115	9-120-690-117	9-120-690-119		

RB-03HA

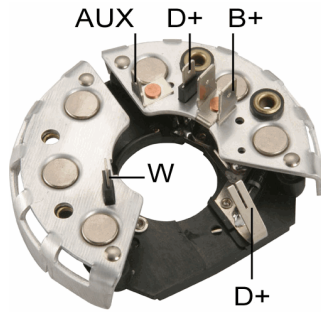

*114mm OD
*6-35 Amp Diodes

Replaces

AUDI/VW :

68903359

BOSCH :

1-127-011-116 1-127-320-506 1-127-320-614 1-127-320-648

Unit no.

BOSCH

0-120-489-080	0-120-489-081	0-120-489-082	0-120-489-083	0-120-489-186	0-120-489-209
0-120-489-210	0-120-489-211	0-120-489-248	0-120-489-249	0-120-489-250	0-120-489-282
0-120-489-283	0-120-489-470	0-120-489-960	0-120-489-961	0-120-489-966	0-120-489-967
0-120-489-968	0-120-489-969	0-120-489-971	0-120-489-972	0-120-489-973	0-120-489-974
0-120-489-975	0-120-489-976	0-120-489-977	0-120-489-978	0-120-489-979	0-120-489-980
0-120-489-981	0-986-031-470	0-986-031-480	0-986-031-481	0-986-031-501	0-986-033-340
0-986-033-350					

RB-04H

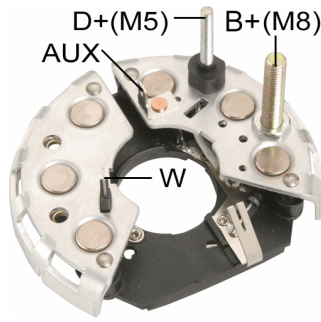

*114mm OD
*6-35 Amp Diodes

Replaces

AUDI/VW :

068903539B 068903539C 069903359D

BOSCH :

1127320664 1127320665 1127320666 1127320661 1127320662 1127320926
1127320945

DELCO REMY (LUCAS) :

21221418

KLOCKNER-HUMBOL-DEUTZ :

1318566

LUCAS :

21221418 UBB420

MAN :

81261090014

VOLVO :

9130086

Unit no.

BOSCH

0-120-488-134	0-120-488-138	0-120-488-205	0-120-488-226	0-120-488-227	0-120-488-238
0-120-488-241	0-120-488-245	0-120-488-246	0-120-488-247	0-120-488-249	0-120-488-257
0-120-488-258	0-120-488-259	0-120-488-260	0-120-488-264	0-120-488-272	0-120-488-285
0-120-489-367	0-120-489-368	0-120-489-369	0-120-489-370	0-120-489-374	0-120-489-376
0-120-489-377	0-120-489-378	0-120-489-379	0-120-489-425	0-120-489-434	0-120-489-435
0-120-489-436	0-120-489-437	0-120-489-438	0-120-489-444	0-120-489-445	0-120-489-446
0-120-489-447	0-120-489-449	0-120-489-495	0-120-489-496	0-120-489-497	0-986-032-930
0-986-034-240	0-986-034-500	0-986-034-501	0-986-034-530	0-986-034-531	0-986-034-560
0-986-034-570	0-986-034-990	0-986-038-050	0-986-038-080		

RB-05H

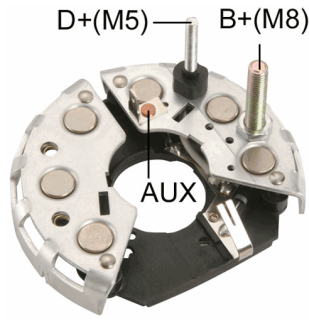

*114mm OD
*6-35 Amp Diodes

Replaces

AUDI/VW :					
036903359E	036903359F	036903359G	036903359H		
BOSCH :					
1-127-320-601	1-127-320-661	1-127-320-662	1-127-320-691		
SAAB :					
8598096	9555301				
VOLVO :					
9130092					

Unit no.

BOSCH					
0-120-469-592	0-120-469-959	0-120-488-196	0-120-488-197	0-120-488-198	0-120-488-199
0-120-488-236	0-120-488-237	0-120-488-239	0-120-488-240	0-120-488-261	0-120-488-262
0-120-488-263	0-120-488-265	0-120-488-279	0-120-489-311	0-120-489-312	0-120-489-362
0-120-489-363	0-120-489-364	0-120-489-365	0-120-489-366	0-120-489-371	0-120-489-372
0-120-489-373	0-120-489-380	0-120-489-381	0-120-489-382	0-120-489-383	0-120-489-427
0-120-489-428	0-120-489-429	0-120-489-430	0-120-489-431	0-120-489-432	0-120-489-433
0-120-489-439	0-120-489-440	0-120-489-441	0-120-489-443	0-120-489-448	0-120-489-499
0-986-034-220	0-986-034-230	0-986-034-231	0-986-034-250	0-986-034-251	0-986-034-510
0-986-034-511	0-986-034-520	0-986-034-550	0-986-034-580	0-986-035-010	0-986-036-260
0-986-036-510	9-120-080-129				

RB-06HA

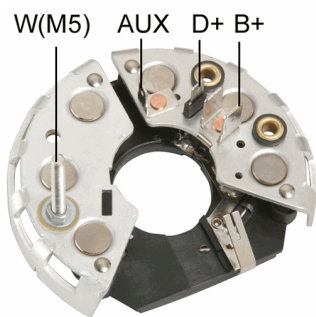

*114mm OD
*6-35 Amp Diodes

Replaces

BOSCH :					
1-127-011-139	1-127-320-372	1-127-320-580	1-127-320-652	1-127-320-673	
DELCO REMY (LUCAS) :					
21221419					
FORD :					
6088149	81AB-10304DA	81DB-10304CA			

Unit no.

BOSCH					
0-120-488-176	0-120-488-177	0-120-488-182	0-120-488-210	0-120-489-047	0-120-489-048
0-120-489-074	0-120-489-075	0-120-489-088	0-120-489-090	0-120-489-091	0-120-489-093
0-120-489-103	0-120-489-175	0-120-489-176	0-120-489-245	0-120-489-267	0-120-489-287
0-120-489-288	0-120-489-290	0-120-489-291	0-120-489-313	0-120-489-314	0-120-489-345
0-120-489-403	0-120-489-426	0-120-489-956	0-120-489-957	0-120-489-958	0-120-489-959
0-986-030-760	0-986-030-761	0-986-030-790	0-986-033-860	0-986-033-940	0-986-034-200
0-986-036-010	0-986-036-020	0-986-036-110	9-120-144-281	9-120-144-282	9-120-144-301

RB-07H

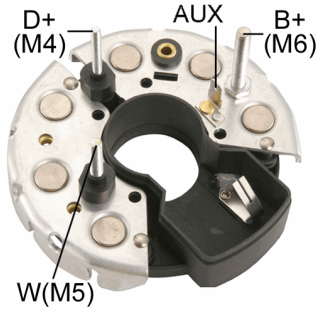

*114mm OD
*6-35 Amp Diodes

Replaces

BOMAG :

5726891

BOSCH :

1-127-011-095	1-127-011-096	1-127-011-097	1-127-011-103	1-127-320-147	1-127-320-331
1-127-320-337	1-127-320-356	1-127-320-358	1-127-320-364	1-127-320-365	1-127-320-368
1-127-320-375	1-127-320-398	1-127-320-540	1-127-320-541	1-127-320-598	1-127-320-604

CLAAS :

1326530

IHC :

3079385R91 3079411R91

JOHN DEERE :

AL30419 AZ31708

KLOCKNER-HUMBOL-DEUTZ :

1304898	1308450	1308783	1309115	42485735	42486339
42487911					

MAN :

81261090001 81261090004 81261090005

MERCEDES-BENZ :

1542016	1542116	1542316	1543016	1543116	1544616
1545716	1546016	1546216			

POCLAIN :

B2140611 C2140612

SONACOME :

1120314 1124036

VOLVO :

244343 244488

Unit no.

BOSCH

0-120-469-603	0-120-469-610	0-120-486-221	0-120-488-125	0-120-488-137	0-120-488-153
0-120-488-289	0-120-488-900	0-120-489-022	0-120-489-023	0-120-489-032	0-120-489-034
0-120-489-060	0-120-489-071	0-120-489-156	0-120-489-231	0-120-489-284	0-120-489-303
0-120-489-643	0-120-489-658	0-120-489-704	0-120-489-710	0-120-489-724	0-120-489-725
0-120-489-728	0-120-489-730	0-120-489-731	0-120-489-756	0-120-489-827	0-120-489-885
0-120-489-886	0-120-489-900	0-120-489-902	0-120-489-944	0-120-489-994	0-120-489-995
0-120-489-996	0-986-031-270	0-986-031-300	0-986-031-320	0-986-031-370	0-986-031-450
0-986-033-820	0-986-035-910	0-986-038-090	9-120-080-114	9-120-080-130	9-120-080-136
9-120-080-137	9-120-080-138	9-120-080-144	9-120-080-150	9-120-080-157	9-120-080-160
9-120-080-162	9-120-080-166	9-120-144-112	9-120-144-113	9-120-144-115	9-120-144-116
9-120-144-117	9-120-144-119	9-120-144-120	9-120-144-137	9-120-334-137	

RB-08H

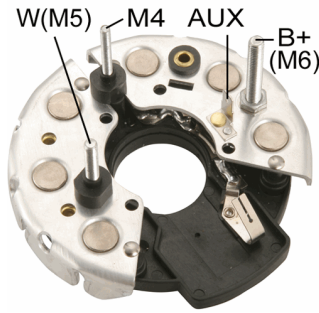

*114mm OD
*6-35 Amp Diodes

Replaces

BOSCH :

1-127-011-098	1-127-011-101	1-127-320-344	1-127-320-363	1-127-320-366	1-127-320-367
1-127-320-545	1-127-320-546	1-127-320-599			

DAF :

694065

FAUN :

4791517

FORD :

6094903 82DB-10304BA

KLOCKNER-HUMBOL-DEUTZ :

1308400 42487053

MAGIRUS-DEUTZ :

8197578 8198257

MERCEDES-BENZ :

1542416 1542516 1542716 1545816 1546316

MWM :

8011080002 8398150001

SAAB :

282916

SCANIA :

282916 305158

STEYR :

61200090706

VOLVO :

6239264 94095

Unit no.

BOSCH

0-120-488-137	0-120-488-224	0-120-489-027	0-120-489-032	0-120-489-053	0-120-489-060
0-120-489-071	0-120-489-192	0-120-489-221	0-120-489-230	0-120-489-231	0-120-489-303
0-120-489-387	0-120-489-388	0-120-489-658	0-120-489-684	0-120-489-702	0-120-489-707
0-120-489-710	0-120-489-723	0-120-489-725	0-120-489-726	0-120-489-727	0-120-489-733
0-120-489-756	0-120-489-757	0-986-030-660	0-986-031-190	0-986-031-230	0-986-031-250
0-986-031-251	0-986-031-260	0-986-031-290	0-986-031-310	0-986-031-330	0-986-033-510
0-986-033-570	0-986-034-210	0-986-034-350	9-120-080-112	9-120-080-113	9-120-080-126
9-120-080-132	9-120-080-134	9-120-080-140	9-120-080-145	9-120-080-149	9-120-080-151
9-120-080-154	9-120-080-158	9-120-144-112	9-120-144-113	9-120-144-115	9-120-144-116
9-120-144-117	9-120-144-120	9-120-144-122	9-120-144-123	9-120-144-125	9-120-144-127
9-120-144-130	9-120-144-131	9-120-144-132	9-120-144-133	9-120-334-137	

RB-101H

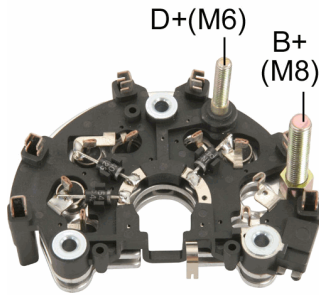

*112mm OD
*6-50A Avalanche Diodes

Replaces

BOSCH :

1-127-319-009 1-127-319-623 1-127-319-862

Unit no.

BOSCH

0-123-320-012 0-986-040-380

RB-105H

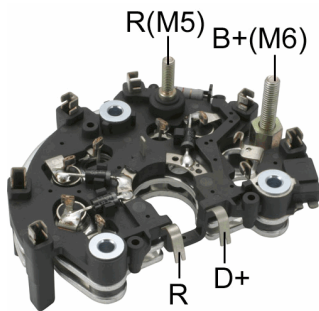

*112mm OD
*6-50A Avalanche Diodes

Replaces

BOSCH :

1-127-319-570

Unit no.

BOSCH

0-120-310-023 0-120-310-048 0-123-320-050

RB-107H

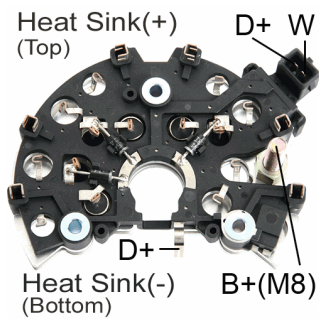

*122mm OD
*M8 Battery Post
*6-50A Avalanche Diodes

Replaces

BOSCH :

1127319572 1127319734 1127319540 1127319572 1127319733 1127319734

Unit no.

BOSCH

0-120-510-053 0-120-510-054 0-120-510-056 0-120-510-065 0-120-515-016

RB-108H

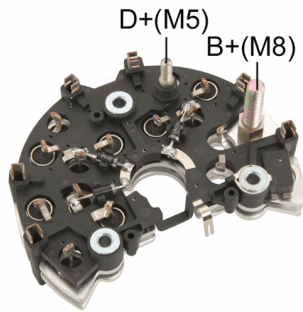

- *122mm OD
- *M8 Battery Post
- *12-50A Avalanche Diodes

Replaces

BOSCH :

1-127-319-035 1-127-319-635 1-127-319-710

Unit no.

BOSCH

0-123-510-004 0-123-510-018 0-123-510-021 0-123-510-060 0-123-510-074 0-123-510-075

RB-109H

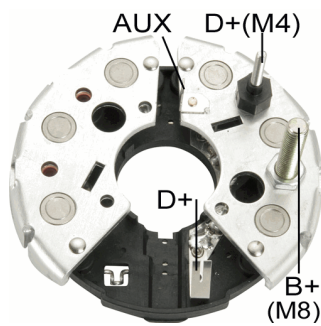

- *114mm OD
- *M8 Battery Post
- *6-35A Avalanche Diodes
- *For use on Rover Mini MKI 1300

Replaces

BOSCH :

1-127-011-186

RB-10H

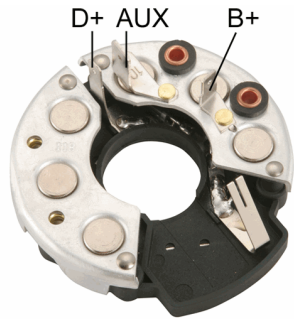

*90mm OD
*6-35 Amp Diodes

Replaces

BOSCH :

1-127-320-152 1-127-320-192 1-127-320-319

FIAT :

4474564 929167 9928604 9934756 9957574 9957575
9959902

MAGNETI MARELLI :

74986411 74995001 74995801 940038202

SAME :

294390902

SEAT :

3898152 NG981008.29

STEYR :

30800090739

Unit no.

BOSCH

0-120-300-568	0-120-300-569	0-120-300-592	0-120-339-515	0-120-339-516	0-120-339-523
0-120-339-526	0-120-339-527	0-120-339-528	0-120-339-534	0-986-030-120	0-986-030-121
0-986-033-077	9-120-143-017	9-120-143-204	9-120-143-218		

RB-110H

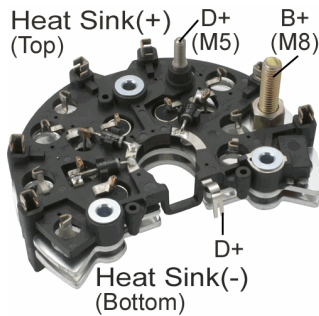

*122mm OD
*6-50A Avalanche Diodes
*M8 Battery Post

Replaces

BOSCH :

1-127-319-558 1-127-319-562 1-127-319-568

Unit no.

BOSCH

0-123-510-023	0-123-510-031 0-123-510-033 0-123-510-038	0-123-510-039	0-123-510-041 0-123-510-044
0-123-510-044	0-123-510-045 0-123-510-049	0-123-510-050	0-123-510-051 0-123-510-058
0-123-510-059	0-123-510-061 0-123-510-066 0-123-510-067	0-123-510-070 0-123-510-072	
0-123-510-080 0-123-510-088 0-123-510-091 0-123-512-500 0-123-515-003 0-123-515-008 0-123-515-009 0-123-515-011 0-123-515-012 0-123-515-024 			

RB-112H

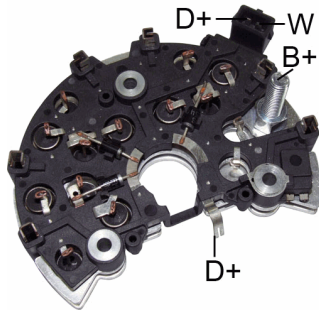

- *122mm OD
- *M8 Battery Post
- *12-50A Avalanche Diodes

Replaces

BOSCH :
1-127-319-631

Unit no.

BOSCH
0-123-520-002 0-123-520-005

RB-113H

Heat Sink(+)
(Top)

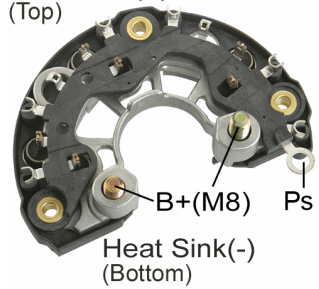

- *120mm OD
- *M8 Battery Post
- *6-50 Avalanche Diodes

Replaces

BOSCH :
F-00M-123-204 F-00M-123-217

Unit no.

BOSCH
0-124-325-006 0-124-325-007 0-124-325-024

RB-115H

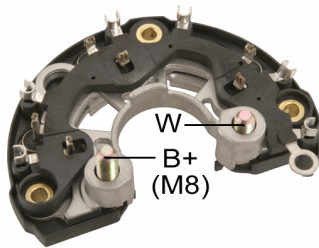

- *120mm OD
- *M8 Battery Post
- *6-50A Avalanche Diodes

Replaces

BOSCH :
F00M123202 F00M123337

Unit no.

BOSCH
0-124-415-001 0-124-415-002 0-124-415-005 0-124-415-006 0-124-415-008 0-124-415-009
0-124-415-010

RB-116H

Heat Sink(+)
(Top)

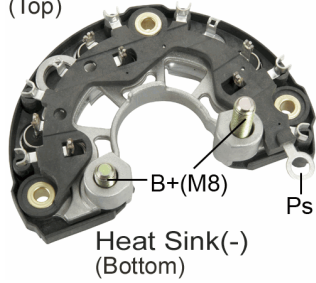

- *120mm OD
- *M8 Battery Post
- *6-50A Avalanche Diodes

Replaces

BOSCH :

F-00M-123-201

Unit no.

BOSCH

0-124-225-010	0-124-315-001	0-124-315-002	0-124-315-003	0-124-315-004	0-124-315-005
0-124-315-006	0-124-315-007	0-124-315-008	0-124-315-010	0-124-315-011	0-124-315-013
0-124-315-014	0-124-320-001	0-124-325-001	0-124-325-002	0-124-325-003	0-124-325-004
0-124-325-011	0-124-325-012				

RB-117H

Heat Sink(+)
(Top)

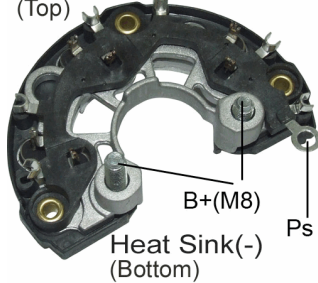

- *120mm OD
- *M8 Battery Post
- *6-50A Avalanche Diodes

Replaces

BOSCH :

F-00M-133-224

Unit no.

BOSCH

0-124-555-001	0-124-555-002	0-124-555-004	0-124-555-007	0-124-555-008	0-124-555-015
0-124-655-001	0-124-655-002	0-124-655-004			

MERCEDES-BENZ

0121541002 0121541102

RB-118H

Heat Sink(+)
(Top)

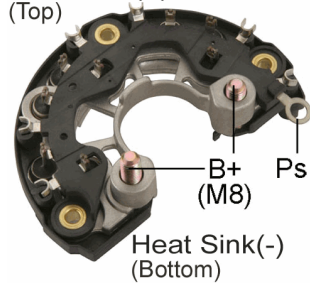

- *120mm OD
- *M8 Battery Post
- *8-50A Avalanche Diodes

Replaces

BOSCH :

F-00M-113-200

Unit no.

BOSCH

0-124-225-001	0-124-225-002	0-124-225-004	0-124-225-009	0-124-225-023	0-124-225-024
0-124-225-025	0-124-225-026	0-124-225-027			

RB-119H

Heat Sink(+)
(Top)

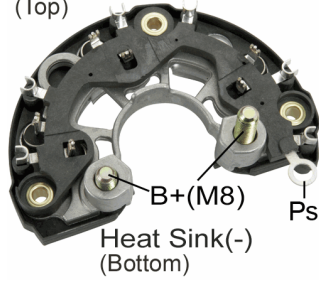

- *120mm OD
- *M8 Battery Post
- *6-50A Avalanche Diodes

Replaces

BOSCH :

F00M133201	F00M133228	F00M133244	F00M133246	F00M133351	F00M133363
------------	------------	------------	------------	------------	------------

Unit no.

BOSCH

0-124-512-013	0-124-515-010	0-124-515-011	0-124-515-012	0-124-515-017	0-124-515-019
0-124-515-020	0-124-515-022	0-124-515-024	0-124-515-025	0-124-515-026	0-124-515-027
0-124-515-034	0-124-515-038	0-124-515-039	0-124-515-054		

RB-11H

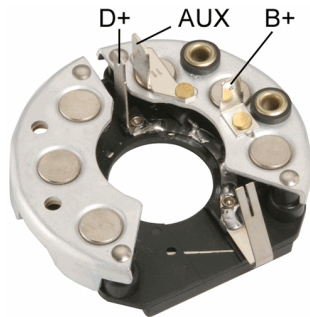

- *90mm OD
- *6-35 Amp Diodes

Replaces

ALFA ROMEO :

208000000	700.2080.000.00	700208
-----------	-----------------	--------

BOSCH :

1-127-320-102	1-127-320-114	1-127-320-122	1-127-320-124	1-127-320-151	1-127-320-173
1-127-320-327					

FIAT :

8223891	82273891	9921409	9923275	9924967	9927730
---------	----------	---------	---------	---------	---------

FORD :

1477518	71BB-10304AA
---------	--------------

HANOMAG :

582901738

MERCEDES-BENZ :

1541216

Unit no.

BOSCH

0-120-300-519	0-120-300-522	0-120-300-523	0-120-300-529	0-120-300-533	0-120-300-540
0-120-300-544	0-120-300-545	0-120-300-546	0-120-300-547	0-120-300-548	0-120-300-551
0-120-300-559	0-120-300-564	0-120-300-588	0-120-339-502	0-120-339-503	0-120-339-504
0-120-339-505	0-120-339-506	0-120-339-509	0-120-339-510	0-120-339-517	0-120-339-518
0-120-339-519	0-120-339-520	0-120-339-522	0-120-339-536		

RB-121H

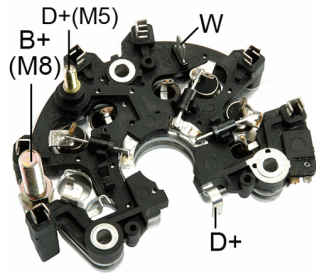

- *112mm OD
- *M8 Battery Post
- *6-50A Avalanche Diodes

Replaces

BOSCH :

1127320807	1127319510	1127319593	1127319729	1127319730	1127320844
1127320864					

Unit no.

BOSCH

0-120-485-011	0-120-485-012	0-120-485-022	0-123-315-005	0-123-320-029	0-123-320-044
0-123-320-045					

RB-122H

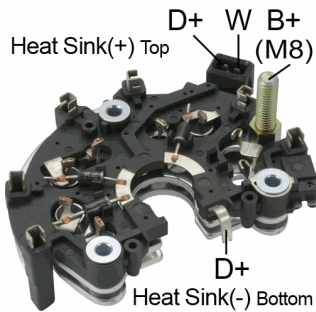

- *112mm OD
- *M8 Battery Post
- *6-50A Avalanche Diodes

Replaces

BOSCH :

1-127-319-552	1-127-320-852
---------------	---------------

Unit no.

BOSCH

0-120-485-034	0-120-485-043	0-120-485-044	0-123-310-002	0-123-310-003	0-123-310-024
0-123-310-025	0-123-310-032	0-123-315-002	0-123-320-017	0-123-320-019	

RB-123H

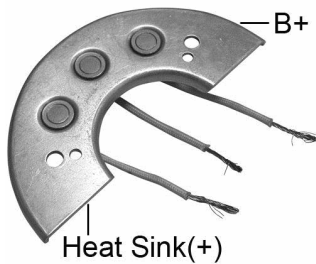

- *3-35 Amp Diodes

Replaces

BOSCH :

1-125-715-064	1-125-715-065	9-121-080-244	9-121-080-349	9-121-080-671	9-121-080-849
---------------	---------------	---------------	---------------	---------------	---------------

Unit no.

BOSCH

9-120-080-020	9-120-080-031	9-120-080-054	9-120-080-082	9-120-080-084	9-120-080-091
9-120-080-110	9-120-080-125				

RB-124H

*w/Diode Trios
*3-35 Amp Diodes

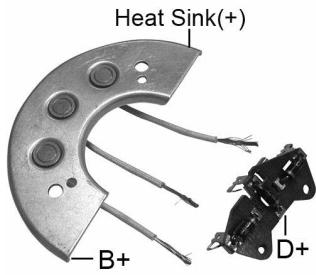

Replaces

BOSCH :

1-125-715-064	1-125-715-065	9-121-080-244	9-121-080-349	9-121-080-671	9-121-080-849
---------------	---------------	---------------	---------------	---------------	---------------

Unit no.

BOSCH

9-120-080-020	9-120-080-031	9-120-080-054	9-120-080-082	9-120-080-084	9-120-080-091
9-120-080-110	9-120-080-125				

RB-125H

*3-35 Amp Diodes

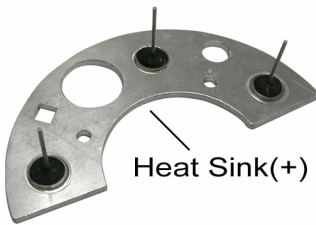

Replaces

BOSCH :

9-121-450-310	9-121-450-311	9-121-450-533
---------------	---------------	---------------

Unit no.

BOSCH

9-190-450-042	9-190-450-044	9-190-450-052	9-190-450-071	9-190-450-100	9-190-450-101
9-190-450-102	9-190-450-113	9-190-450-118	9-190-450-119		

RB-128H

*3-35 Amp Diodes

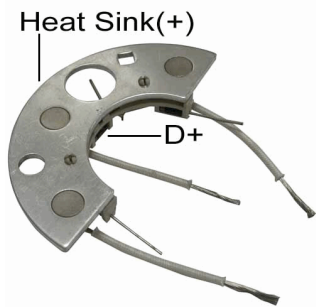

Replaces

BOSCH :

9-121-450-310	9-121-450-311	9-121-450-533
---------------	---------------	---------------

Unit no.

BOSCH

9-120-450-042	9-120-450-044	9-120-450-052	9-120-450-053	9-120-450-058	9-120-450-071
9-120-450-085	9-120-450-090	9-120-450-092	9-120-450-093	9-120-450-100	9-120-450-102
9-120-450-113	9-120-450-130	9-120-450-132			

RB-12H

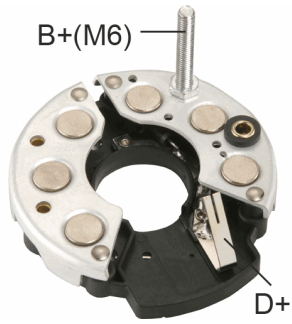

*90mm OD
*6-35 Amp Diodes

Replaces

ALFA ROMEO :

116.0005.061.00 116.0005.061.21

BOSCH :

1-127-320-118 1-127-320-121 1-127-320-342

OPEL :

1205552

Unit no.

BOSCH

0-120-300-531 0-120-300-537 0-120-300-539

RB-130H

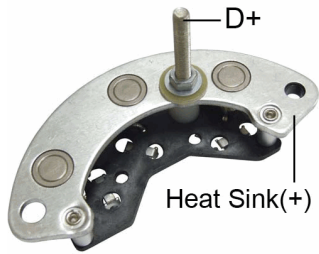

*w/Diode Trios
*M5 Battery Post
*3-35 Amp Diodes

Replaces

BOSCH :

9-121-080-374

Unit no.

BOSCH

9-120-080-045 9-120-080-049 9-120-080-057 9-120-080-085 9-120-080-094 9-120-080-107

9-120-080-138 9-120-080-146

RB-131H

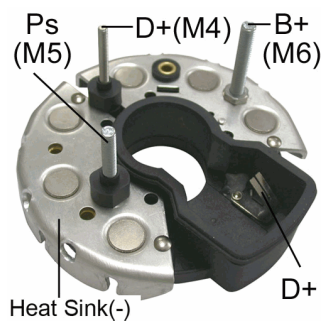

*6-35 Amp Diodes
*M6 Battery Post

Replaces

BOSCH :

9-122-080-509

Unit no.

BOSCH

9-120-080-181 9-120-080-183 9-120-080-219

RB-132H

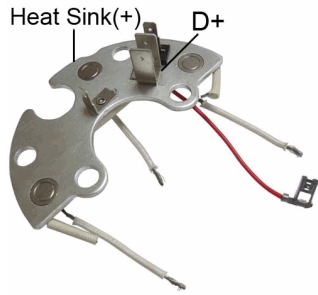

*w/Diode Trios
*3-35 Amp Diodes

Replaces

BOSCH :
9-121-450-587

Unit no.

BOSCH
9-120-450-110

RB-134H

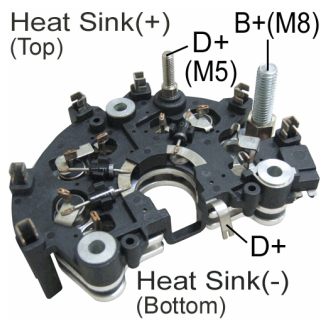

*M5 Battery Post
*6-50A Avalanche Diode

Replaces

BOSCH :
1-127-319-011 1-127-319-560 1-127-319-749

Unit no.

BOSCH
0-123-310-042 0-123-315-020 0-123-315-500 0-123-320-030

RB-135H

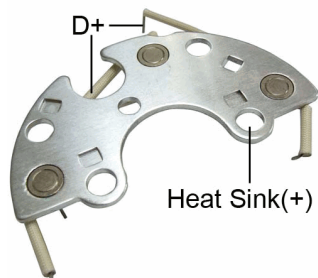

*w/Diode Trios
*3-35 Amp Diodes

Replaces

BOSCH :
9-121-450-574

Unit no.

BOSCH
9-120-450-014 9-120-450-073 9-120-450-129 9-120-450-133 9-120-450-134 9-120-450-137

RB-137H

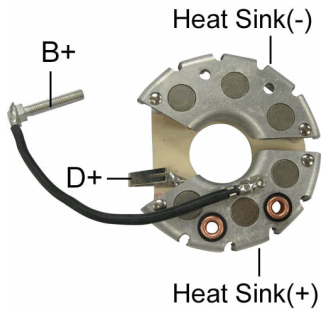

*M6 Battery Post
*6-35A Amp Diodes

Replaces

BOSCH :
9-121-080-595

Unit no.

BOSCH
9-120-080-041 9-120-080-061 9-120-080-072 9-120-080-090

RB-137HV

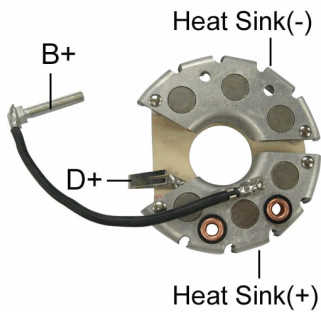

Same as RB-137H but W/6-50 Amp Diodes
*M6 Battery Post

Replaces

BOSCH :
9-121-080-595

Unit no.

BOSCH
9-120-080-041 9-120-080-061 9-120-080-072 9-120-080-090

RB-138H

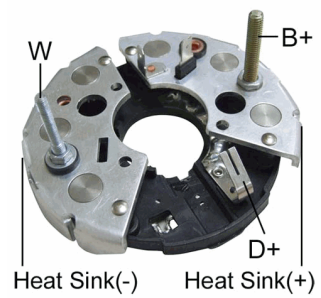

*M5 Battery Post
*6-35 Amp Diodes

Replaces

BOSCH :
9-122-080-638

Unit no.

BOSCH
9-120-080-197

RB-13H

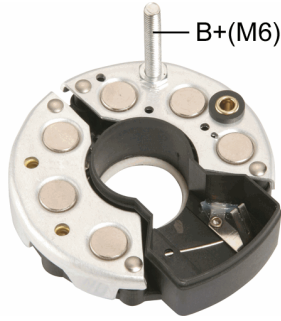

- *90mm OD
- *M6 Battery Post
- *6-35 Amp Diodes

Replaces

BOMAG :

5726892

BOSCH :

1-127-320-115	1-127-320-116	1-127-320-141	1-127-320-142	1-127-320-146	1-127-320-316
1-127-320-317	1-127-320-569	1-227-320-116	1-237-320-345		

IHC :

3078957R91 3078957R92

JOHN DEERE :

AL27374 AZ24486

KLOCKNER-HUMBOL-DEUTZ :

1306533 9941262

LAMBORGHINI :

294390706 294391002

MWM :

8011080001 8339940004 833994001 8398150001 839815001

Unit no.

BOSCH

0-120-300-535	0-120-300-552	0-120-300-562	0-120-300-567	0-120-300-575	0-120-300-576
0-120-300-577	0-120-300-578	0-120-300-579	0-120-300-580	0-120-300-584	0-120-300-585
0-120-300-586	0-120-300-589	0-120-300-590	0-120-339-511	0-120-339-512	0-120-339-513
0-120-339-514	0-120-339-521	0-120-339-531	0-120-339-532	0-120-339-535	0-120-339-536
0-120-339-537	0-120-339-538	0-120-339-542	0-120-339-544	0-120-339-545	0-120-339-584
0-120-400-836	0-120-400-837	0-986-030-110	0-986-030-130	0-986-030-140	0-986-031-120
9-120-143-003	9-120-143-021	9-120-143-025	9-120-143-026	9-120-143-201	9-120-143-202
9-120-143-222	9-120-143-223	9-120-143-228			

RB-141H

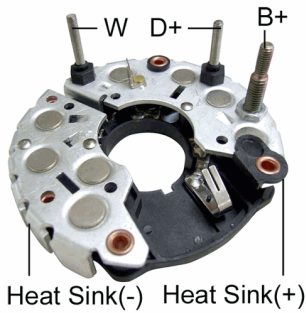

- *M8 Battery Post
- *8-50 Amp Diodes

Replaces

BOSCH :

9-128-041-566

RB-145H

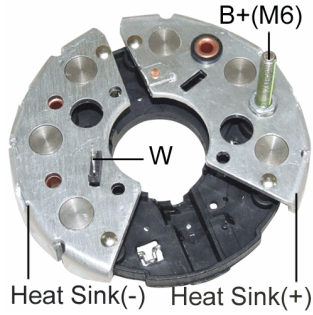

*M6 Battery Post
*6-35 Amp Diodes

Replaces

BOSCH :
9-122-080-923

Unit no.

BOSCH
9-120-080-215 9-120-080-222 9-120-080-231

RB-146H

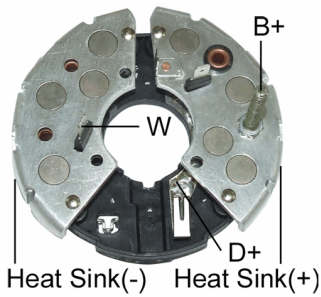

*M6 Battery Post
*8-35A Avalanche Diode

Replaces

BOSCH :
F-000-LD1-006

Unit no.

BOSCH
9-120-080-226 9-120-080-232 F-000-LD0-100 F-000-LD0-102

RB-148H

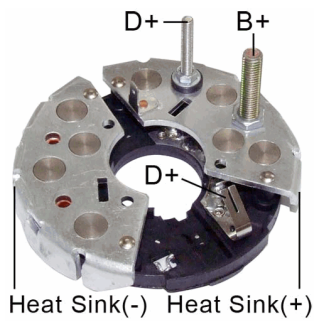

*M8 Battery Post
*8-35 Amp Diodes

Replaces

BOSCH :
9-122-080-676

Unit no.

BOSCH
9-120-080-167

RB-14H

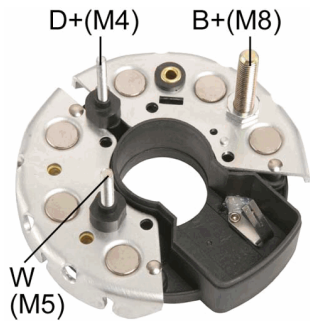

- *114mm OD
- *M8 Battery Post
- *6-35 Amp Diodes

Replaces

BOSCH :
 1-127-320-909 9-127-041-132 9-127-041-133

MERCEDES-BENZ :
 1547016

Unit no.

BOSCH
 0-120-489-316

RB-158H

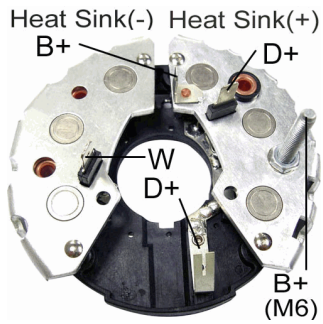

- *115mm OD
- *M6 Battery Post
- *6-35 Amp Diodes

Replaces

BOSCH :
 F-000-LD1-012

Unit no.

BOSCH
 9-120-080-212 9-120-080-230

RB-159H

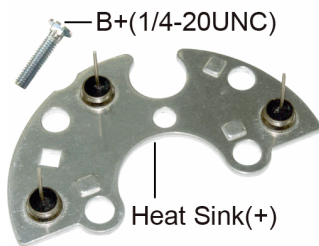

- *115mm OD
- *3-35 Amp Diodes

Unit no.

BOSCH
 9-120-450-006 9-120-450-124

FORD
 87HLL-10300DA E5HT-10300EA

RB-15H

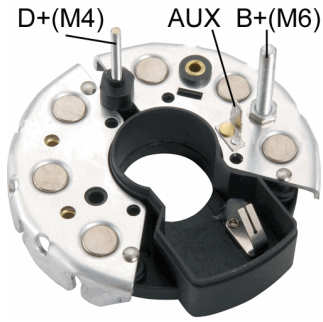

- *114mm OD
- *M6 Battery Post
- *6-35 Amp Diodes

Replaces

BOSCH :
1-127-320-668

Unit no.

BOSCH
0-120-488-125 0-120-489-156 0-120-489-643 0-120-489-703 0-120-489-704 0-986-033-320
9-120-144-119

RB-160H

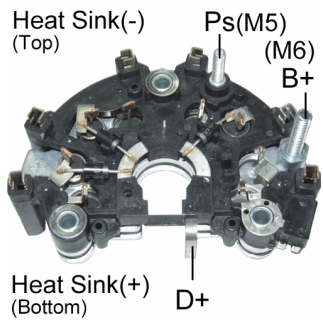

- *112mm OD
- *M6 Battery Post
- *6-50A Avalanche Diodes

Replaces

BOSCH :
1-127-319-584

Unit no.

BOSCH
0-120-485-029 0-123-310-014 0-123-310-015 0-123-310-029 0-123-310-053 0-123-320-014
0-986-036-690 0-986-038-660

Used On

FORD

Escort	1992-2000
Fiesta	1992-2000
Escort 1.6L 16V	1995-2000

RB-161H

Heat Sink(+)
(Top)

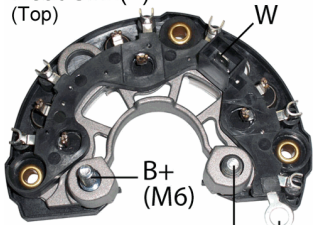

Heat Sink(-)
(Bottom)

B+(M8)

Ps

- *120mm OD
- *M6 Battery Post
- *6-50 Avalanche Diodes

Unit no.

BOSCH

0-124-325-064

FORD

1C35-10300AA 1C35-10300AB

Used On

FORD

Truck 3.9L

1998-2006

RB-163H

Heat Sink(+)
(Top)

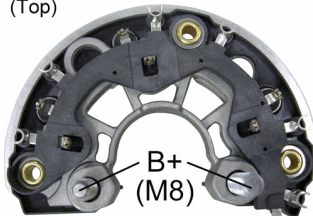

Heat Sink(-)
(Bottom)

Ps

- *130mm OD
- *M8 Battery Post
- *6-50A Avalanche Diodes

Replaces

BOSCH :

F-00M-133-206 F-00M-133-230 F-00M-133-248

Unit no.

BOSCH

0-124-515-028 0-124-515-040

RB-166H

Heat Sink(+)
(Top)

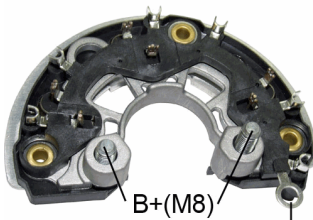

Heat Sink(-)
(Bottom)

Ps

- *130mm OD
- *M8 Battery Post
- *6-70A Avalanche Diodes

Replaces

BOSCH :

F00M133276 F00M133249 F00M133204 F00M133214 F00M133215 F00M133218
 F00M133229 F00M133247

Unit no.

BOSCH

0-124-625-001 0-124-625-003 0-124-625-005 0-124-625-006 0-124-625-007 0-124-625-010
 0-124-625-020 0-124-625-022 0-124-625-024 0-124-625-025 0-124-625-026 0-124-625-028

RB-167HV

Heat Sink(+)(Top)

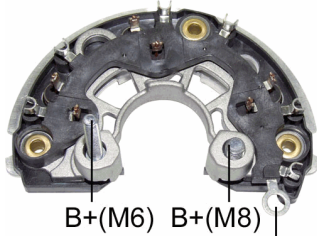

Heat Sink(-)(Bottom) Ps

- *130mm OD
- *M8 Battery Post
- *6-50A Avalanche Diodes
- *□ connection

Replaces

BOSCH :

F-00M-123-265

Unit no.

BOSCH

0-124-325-121 0-124-325-153

GENERAL MOTORS

15200267 15222342

RB-168H

Heat Sink(+)(Top)

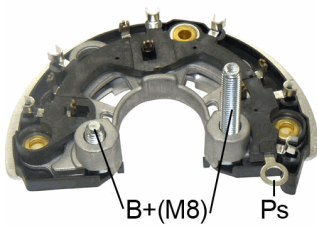

Heat Sink(-)(Bottom)

- *130mm OD
- *M8 Battery Post
- *6-50A Avalanche Diodes

Replaces

BOSCH :

F00M133226 F00M133369 F00M133372

Unit no.

BMW

12317501595 12317501597 12317501599 12317501690

BOSCH

0-124-515-050 0-124-515-097

RB-16H

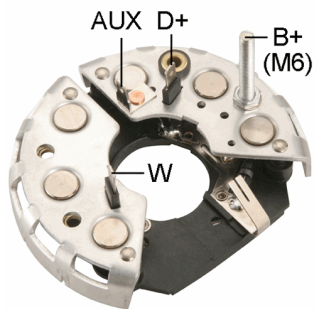

- *114mm OD
- *M6 Battery Post
- *6-35 Amp Diodes

Replaces

BOSCH :

1-127-011-131

Unit no.

BOSCH

0-120-489-069 0-120-489-070 0-120-489-183 0-120-489-286 0-120-489-294 0-120-489-296
 0-120-489-475 0-120-489-481

RB-170HD

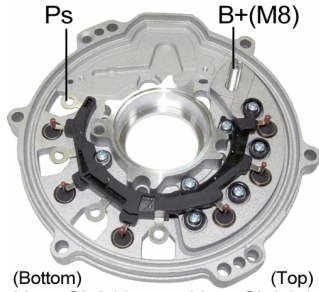

*M8 Battery Post
*6-70A Avalanche Diodes

Replaces

BOSCH :
F-00M-256-202

Unit no.

BOSCH
0-122-468-015

RB-171HV

Heat Sink(+)(Top)

*120mm OD
*6-50 Amp Diodes

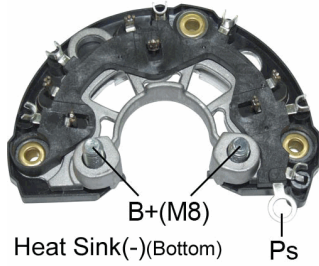

Replaces

BOSCH :
F-00M-133-202

Unit no.

BOSCH
0-124-525-002 0-124-525-003 0-124-525-006 0-124-525-007 6-004-ML0-000 6-004-ML0-001
6-004-ML0-005
CHRYSLER
56041120AC 56041322 56041322AB

Used On

DODGE

Dakota Pickup 4.7L 2000 -
Durango 4.7L 2000 -

JEEP

Grand Cherokee 4.0L 1999-2000
Grand Cherokee 4.7L 1999-2000

RB-172H

Heat Sink(+)
(Top)

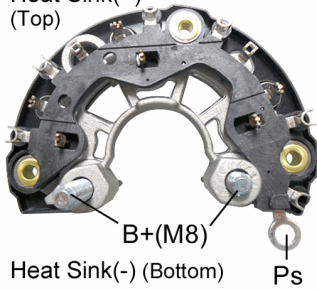

- *120mm OD
- *M8 Battery Post
- *6-50A Avalanche Diodes

Replaces

BOSCH :
F00M123249 F00M123228 F00M123255

Unit no.

BOSCH
0-124-325-066 0-124-325-076

RB-174HD

Heat Sink(-) (Bottom) Heat Sink(+)
(Top)

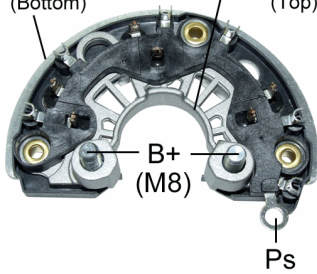

- *130mm OD
- *M8 Battery Post
- *6-70A Avalanche Diodes

Replaces

BOSCH :
F-00M-133-267 F-00M-133-311

Unit no.

BMW
12317532965 12317532966 12317532969 12317533270

BOSCH
0-124-525-059

Used On

BMW

116	2004-
118	2004-
120	2004-
Z4 Series	2004-
316 1.6L	2001-2005
318 1.6L	2001-2005

RB-175HD

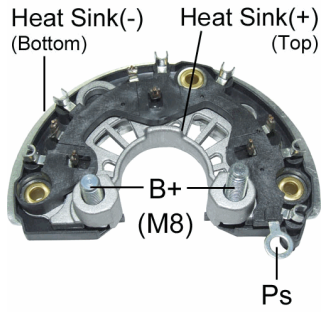

- *130mm OD
- *M8 Battery Post
- *6-70A Avalanche Diodes

Replaces

BOSCH :

F-00M-133-265 F-00M-133-278 F-00M-133-312 F-00M-133-313

Unit no.

BOSCH
0-124-525-026

Used On

BMW

325 Series 2.5L	2004-
525i 2.5L	2004-
X3 2.5L	2004-
Z4 3.0L	2003-
Z4 2.5L	2003-

RB-178H

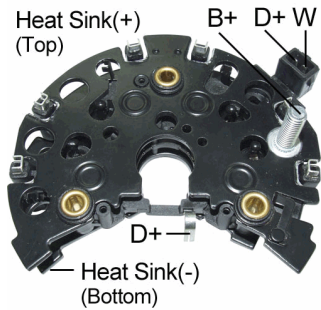

- *122mm OD
- *6-35 Amp Diodes

Replaces

BOSCH :

1127319738 1127320854 1127319737 1127319576

VOLKSWAGEN :

028-903-359G

Unit no.

BOSCH
0-986-038-950 0-986-039-030 0-986-040-940 0-120-465-019 0-120-465-021

Used On

VOLKSWAGEN

Corrado 2.8L	1992-
Corrado V6 ABV	1992-1995
Vento 2800 V6	1992-1995

RB-179HV

Heat Sink(+)
(Top)

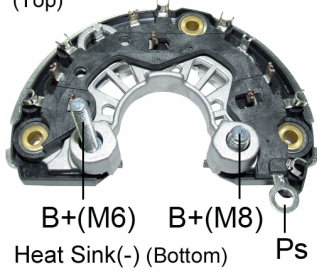

- *130mm OD
- *M8 Battery Post
- *6-50A Avalanche Diodes
- *Y connection

Replaces

BOSCH :
F-00M-123-266

Unit no.

BOSCH
0-124-325-133
GM
15124532

RB-17H

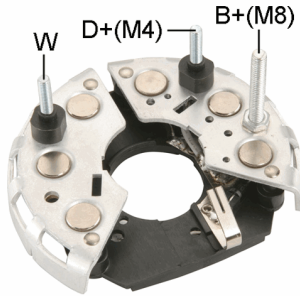

- *114mm OD
- *M8 Battery Post
- *6-35 Amp Diodes

Replaces

BOSCH :
9-121-147-302

OPEL :
1205568 90010012

Unit no.

BOSCH					
0-120-488-000	0-120-488-001	0-120-488-002	0-120-488-003	0-120-488-004	0-120-488-005
0-120-488-007	0-120-488-008	0-120-488-009	0-120-488-010	0-120-488-011	0-120-488-012
0-986-034-450	9-120-144-292	9-120-144-305	9-120-144-605	9-120-144-606	9-120-144-608
9-120-144-609	9-120-144-610	9-120-144-611	9-120-144-612	9-120-144-613	9-120-144-614
9-120-144-617	9-120-144-618	9-120-144-621	9-120-144-622	9-120-144-626	9-120-144-635
9-120-334-626	9-120-334-628	9-120-334-635	9-120-344-628		

RB-180HV

Heat Sink(+)
(Top)

- *120mm OD
- *M8 Battery Post
- *6-50 Amp Diodes

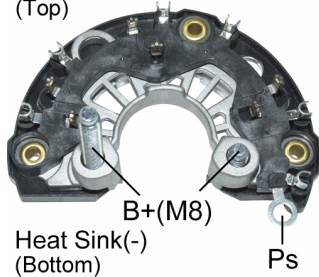

Heat Sink(-)
(Bottom)

Replaces

BOSCH :
F-00M-133-225

Unit no.

BOSCH				
0-124-425-001	0-124-525-004	0-124-525-005	0-124-525-041	0-124-525-105
CHRYSLER				
4801475AA	AB; 56028238AB	56028239AB	56028732AA	

Used On

DODGE

Ram 1500 3.9L	1999-2000
Ram 1500 5.2L	1999-2000
Ram 1500 5.9L	1999-2000
Ram 2500 8.0L	1999-2000
3500 8.0L	1999-2000
Ram 4000 5.9L	1999-2000

RB-181HD

Heat Sink(+)
(Top)

- *M8 Battery Post
- *6-70A Avalanche Diodes

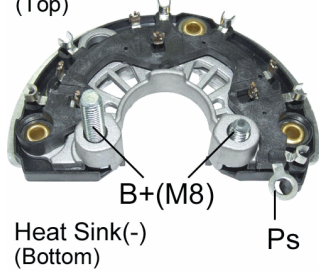

Heat Sink(-)
(Bottom)

Replaces

BOSCH :
F-00M-133-274 F-00M-133-292

Unit no.

BOSCH	
0-124-525-054	0-124-525-055

RB-18H

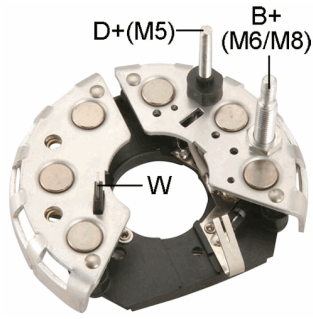

- *114mm OD
- *M6/M8 Battery Post
- *6-35 Amp Diodes

Replaces

BOSCH :
1127320914

GM :
90350009

OPEL :
1205572

Unit no.

BOSCH
0-120-488-186 0-120-488-187

RB-19H

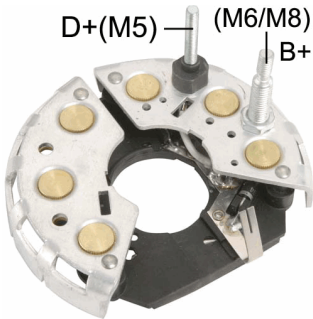

- *114mm OD
- *M6/M8 Battery Post
- *6-35 Amp Diodes

Replaces

BOSCH :
1-127-320-651 1-127-320-677

GM :
90349909

OPEL :
1205571 1205573 90017587

Unit no.

BOSCH

0-120-488-156	0-120-488-157	0-120-488-158	0-120-488-159	0-120-488-160	0-120-488-161
0-120-488-162	0-120-488-163	0-120-488-164	0-120-488-165	0-120-488-166	0-120-488-167
0-120-488-168	0-120-488-169	0-120-488-170	0-120-488-171	0-120-488-172	0-120-488-173
0-120-488-174	0-120-488-175	0-120-488-190	0-120-488-191	0-120-488-192	0-120-488-193
0-120-488-200	0-120-488-201	0-120-488-202	0-120-488-203	0-120-488-204	0-120-488-255
0-120-488-281	0-986-030-840	0-986-030-880	0-986-030-920	0-986-030-930	0-986-034-650
0-986-034-651	0-986-034-660	0-986-034-930	0-986-036-530	0-986-036-540	

RB-24H

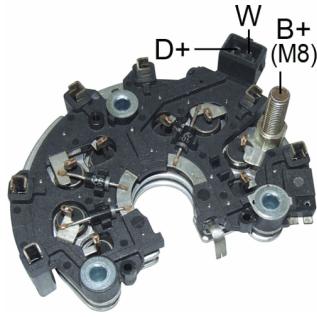

- *112mm OD
- *M8 Battery Post
- *8-50A Avalanche Diodes

Replaces

BOSCH :

1-127-319-667 1-127-320-850

Unit no.

BOSCH

0-120-485-036	0-120-485-038	0-120-485-039	0-123-320-001	0-123-320-002	0-123-320-005
0-123-340-002	0-123-340-003	0-123-340-005			

RB-26H

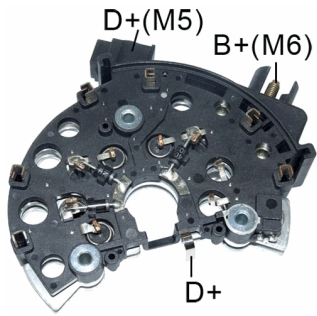

- *122mm OD
- *M6 Battery Post
- *6-50A Avalanche Diodes

Replaces

BOSCH :

1-127-319-033 1-127-319-580 1-127-319-715

Unit no.

BOSCH

0-123-212-001

RB-28H

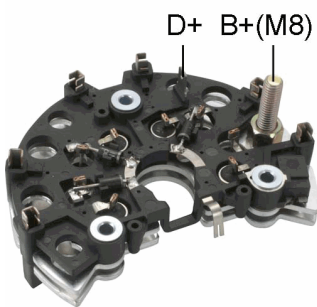

- *122mm OD
- *M8 Battery Post
- *8-50A Avalanche Diodes

Replaces

BOSCH :

1-127-319-512 1-127-320-818

Unit no.

BOSCH

0-120-465-018 0-120-465-029

RB-29H

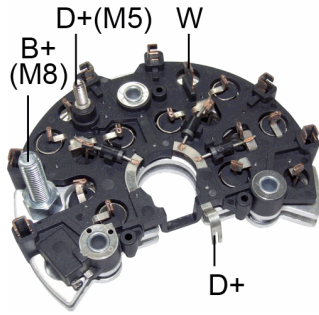

- *122mm OD
- *M8 Battery Post
- *14-50A Avalanche Diodes

Replaces

BOSCH :

1-127-319-031 1-127-319-637

Unit no.

BOSCH

0-120-465-003 0-120-465-004 0-120-465-013 0-120-465-014

RB-30H

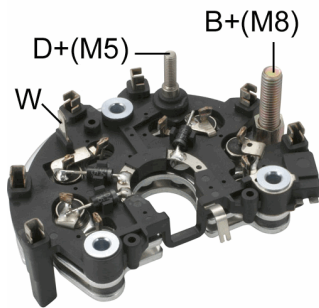

- *112mm OD
- *M8 Battery Post
- *8-50A Avalanche Diodes

Replaces

BOSCH :

1-127-319-019

Unit no.

BOSCH

0-123-320-003 0-123-340-001 0-124-485-020 0-124-485-023

RB-32H

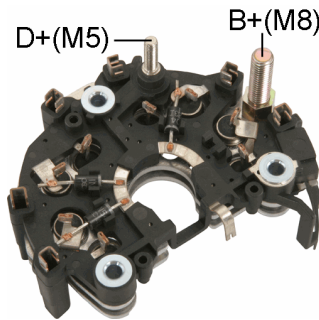

- *106mm OD
- *M8 Battery Post
- *8-50A Avalanche Diodes

Replaces

BOSCH :

1-127-319-005 1-127-319-601 1-127-319-766

Unit no.

BOSCH

0-123-110-005 0-123-120-001

RB-33H

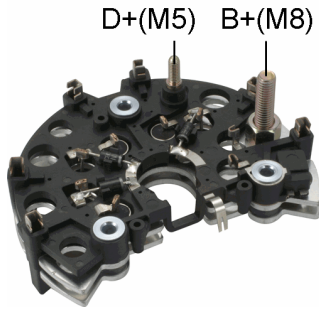

- *122mm OD
- *M8 Battery Post
- *6-50A Avalanche Diodes

Replaces

BOSCH :

1127319013 1127319597 1127319778 1127319743 1127319744 1127319665

Unit no.

BOSCH

0-123-505-001 0-123-505-004 0-123-510-003 0-123-510-020 0-123-510-052

RB-36H

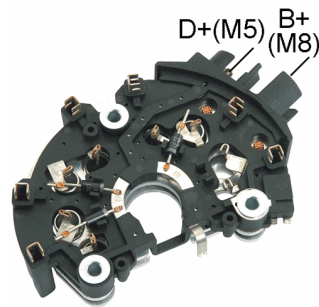

- *112mm OD
- *M8 Battery Post
- *6-50A Avalanche Diodes

Replaces

BOSCH :

1-127-319-522 1-127-319-607 1-127-319-694

Unit no.

BOSCH

0-123-310-010 0-123-310-011 0-123-310-012 0-123-310-013 0-123-320-017

RB-37H

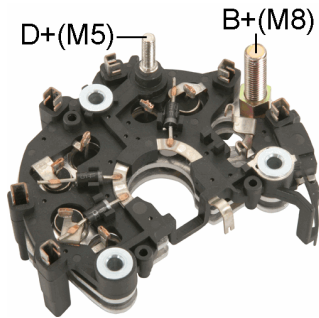

- *112mm OD
- *M8 Battery Post
- *6-50A Avalanche Diodes

Replaces

BOSCH :

1-127-319-530 1-127-319-599 1-127-319-726

Unit no.

BOSCH

0-123-100-001 0-123-100-002

RB-38H

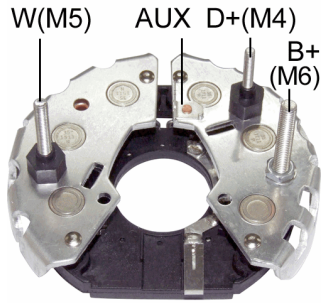

- *114mm OD
- *M6 Battery Post
- *6-35 Amp Diodes

Replaces

BOSCH :	
1127320667	1127319113
FORD :	
6156187	86AB10304AA
GM :	
90350013	
LUCAS :	
2131030	UBB429
MAGNETI MARELLI :	
940038210	

Unit no.

BOSCH					
0-120-488-228	0-120-488-286	0-120-489-346	0-120-489-347	0-120-489-389	0-120-489-392
0-120-489-408	0-986-034-470				

RB-40H

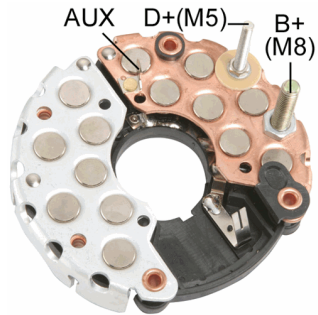

- *120mm OD
- *M8 Battery Post
- *14-35 Amp Diodes

Replaces

BOSCH :	
1-127-320-584	1-127-320-608

Unit no.

BOSCH	
0-120-469-623	0-127-469-624

RB-41H

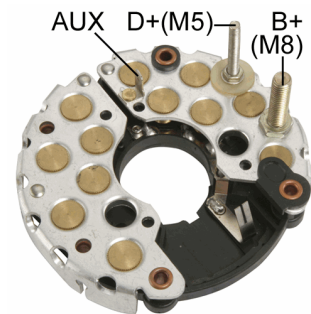

- *120mm OD
- *12-35 Amp Diodes

Replaces

BOSCH :	
1-127-011-157	1-127-320-565

Unit no.

BOSCH			
0-120-469-586	0-120-469-588	0-120-469-589	0-120-469-590

RB-42H

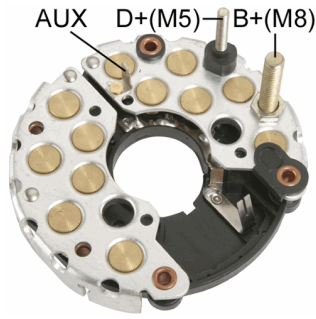

*120mm OD
*12-35 Amp Diodes

Replaces

BOSCH :

1-127-320-369

FORD :

78GB-10304AA

MERCEDES-BENZ :

1543516

Unit no.

BOSCH

0-120-469-516	0-120-469-517	0-120-469-530	0-120-469-531	0-120-469-570	0-120-469-571
0-120-469-573	0-120-469-574	0-120-469-594	0-120-469-595	0-986-030-560	0-986-030-561

RB-43H

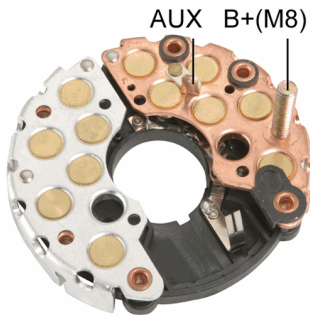

*120mm OD
*12-35 Amp Diodes

Replaces

AUDI/VW :

053903359C

BOSCH :

1-127-320-360 1-127-320-538

LUCAS :

21221435

MERCEDES-BENZ :

1544116

Unit no.

BOSCH

0-120-469-515	0-120-469-534	0-120-469-535	0-120-469-555	0-120-469-556	0-120-469-558
0-120-469-583	0-120-469-584	0-120-469-721	0-986-030-510	0-986-033-110	0-986-033-140

RB-44H

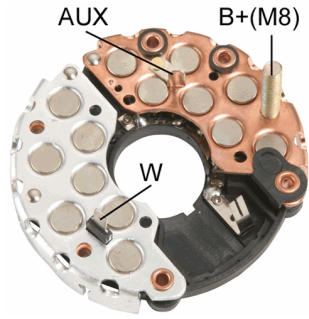

*120mm OD
*14-35 Amp Diodes

Replaces

BOSCH :
1-127-320-516

Unit no.

BOSCH
0-120-469-545 0-120-469-546 0-120-469-547 0-120-469-548 0-120-469-607

RB-45H

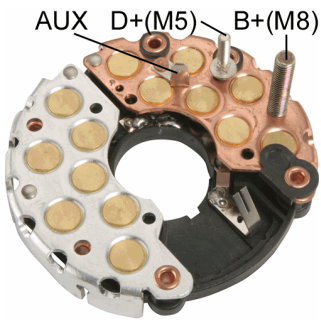

*120mm OD
*14-35 Amp Diodes

Replaces

AUDI/VW :
63903359

BOSCH :
1127320531 1127320159 1127320172 1127320330 1127320350 1127320360
1127320538 1127320542 1127320359

LUCAS :
UBB425

MERCEDES-BENZ :
1540116 1543816 1546516

OPEL :
1205445

Unit no.

BOSCH
0-120-450-004 0-120-469-500 0-120-469-501 0-120-469-510 0-120-469-511 0-120-469-524
0-120-469-525 0-120-469-534

RB-46H

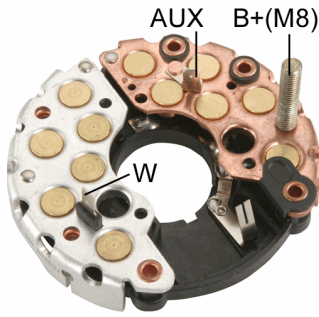

*120mm OD
*12-35 Amp Diodes

Replaces

AUDI/VW :
069903359A

BOSCH :
1-127-320-515

Unit no.

BOSCH

0-120-469-541	0-120-469-542	0-120-469-543	0-120-469-544	0-120-469-598	0-120-469-599
---------------	---------------	---------------	---------------	---------------	---------------

RB-47H

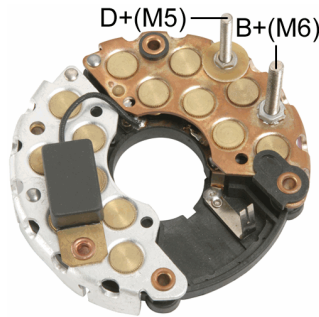

*120mm OD
*14-35 Amp Diodes

Replaces

BOSCH :
1-127-320-370

Unit no.

BOSCH

0-120-450-008	0-120-450-009	0-120-469-564	0-120-469-567	0-120-469-568	0-120-469-628
0-120-469-664	0-120-469-668	0-120-469-670	0-120-469-680	0-120-469-681	0-986-032-990
0-986-033-010	0-986-034-380				

RB-48H

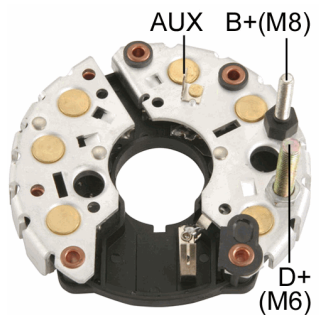

*120mm OD
*6-35 Amp Diodes

Replaces

BOSCH :
1-127-320-721

Unit no.

BOSCH

0-120-469-828	0-120-469-829	0-120-469-830	0-120-469-918	0-120-469-919	0-986-036-770
---------------	---------------	---------------	---------------	---------------	---------------

RB-49H

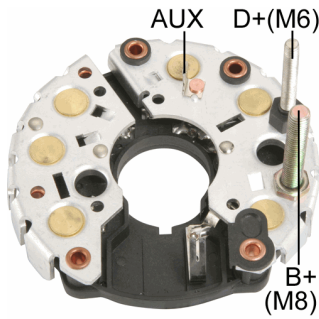

*120mm OD
*6-35 Amp Diodes

Replaces

BOSCH :

1127320717 1127320726 1127320734 1127320740 1127320935

Unit no.

BOSCH

0-120-468-042	0-120-468-043	0-120-468-061	0-120-468-062	0-120-468-063	0-120-468-064
0-120-468-075	0-120-468-076	0-120-468-077	0-120-468-078	0-120-468-102	0-120-468-103
0-120-468-104	0-120-468-105	0-120-468-110	0-120-469-967	0-120-469-968	0-120-469-969
0-120-469-973	0-120-469-974	0-120-469-984	0-120-469-985	0-123-510-017	0-986-035-740
0-986-035-750	0-986-036-760	0-986-038-310	0-986-038-330	0-986-038-750	

RB-50H

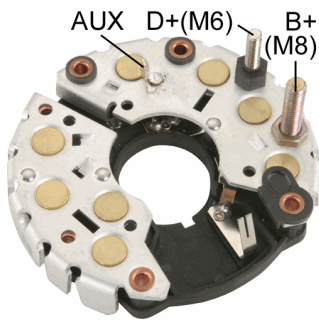

*120mm OD
*8-35 Amp Diodes

Replaces

BOSCH :

1-127-320-727

Unit no.

BOSCH

0-120-469-878 0-120-469-879 0-120-469-913 0-120-469-914

RB-51H

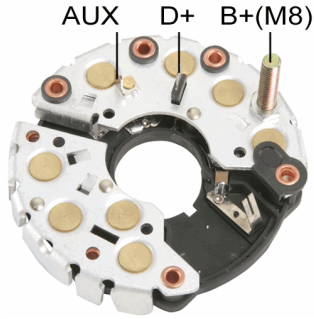

*120mm OD
*8-35 Amp Diodes

Replaces

BOSCH :

1-127-320-700 1-127-320-730

FIAT :

9941712 9942883 9950118 9950193

FORD :

1632835 E5RD10304AA

Unit no.

BOSCH

0-120-469-028	0-120-469-029	0-120-469-034	0-120-469-035	0-120-469-631	0-120-469-632
0-120-469-633	0-120-469-635	0-120-469-636	0-120-469-671	0-120-469-672	0-120-469-696
0-120-469-697	0-120-469-698	0-120-469-699	0-120-469-700	0-120-469-708	0-120-469-712
0-120-469-715	0-120-469-716	0-120-469-720	0-120-469-847	0-120-469-848	0-120-469-858
0-120-469-859	0-120-469-860	0-120-469-861	0-120-469-875	0-120-469-892	0-120-469-893
0-120-469-937	0-120-469-939	0-120-469-940	0-120-469-979	0-120-469-980	0-120-469-981
0-986-032-730	0-986-033-160	0-986-034-130	0-986-034-150	0-986-034-160	0-986-035-700
0-986-035-710	0-986-035-720	0-986-036-780			

RB-52H

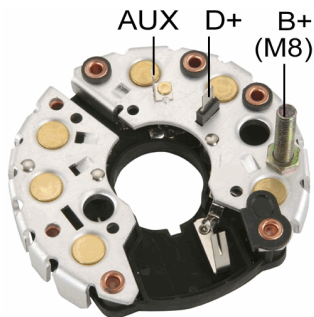

*120mm OD
*6-35 Amp Diodes

Replaces

BOSCH :

1-127-320-704

FIAT :

9939575 9950067

Unit no.

BOSCH

0-120-469-646	0-120-469-647	0-120-469-666	0-120-469-710	0-120-469-836	0-986-035-020
0-986-035-770					

RB-53H

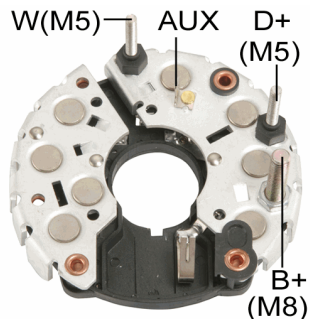

*120mm OD
*8-35 Amp Diodes

Replaces

BOSCH :

1-127-320-706

FORD :

6153350 85GB-10304CA 86GB-10304CA

Unit no.

BOSCH

0-120-469-009	0-120-469-032	0-120-469-659	0-120-469-660	0-120-469-661	0-120-469-662
0-120-469-713	0-120-469-747	0-120-469-748	0-120-469-871	0-120-469-874	0-120-469-899
0-120-469-958	0-986-034-140	0-986-036-000			

RB-54H

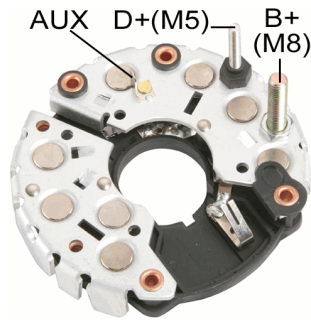

*120mm OD
*8-35 Amp Diodes

Replaces

AUDI/VW :

037903359A 26903359 27903359

BMW :

12311715167

BOSCH :

1-127-320-705	1-127-320-715	1-127-320-723	1-127-320-725	1-127-320-728	1-127-320-732
1-127-320-739	1-127-320-745	1-127-320-749			

LUCAS :

UBB433

MAGNETI MARELLI :

940038208

MERCEDES-BENZ :

1545916

OPEL :

1205453 90349703 90443928

Unit no.

BOSCH

0-120-427-988	0-120-468-017	0-120-468-018	0-120-468-019	0-120-468-020	0-120-468-022
0-120-468-023	0-120-468-024	0-120-468-025	0-120-468-026	0-120-468-027	0-120-468-029
0-120-468-044	0-120-468-052	0-120-468-056	0-120-468-068	0-120-468-069	0-120-468-070
0-120-468-079	0-120-468-101	0-120-468-106	0-120-468-108	0-120-468-109	0-120-468-112
0-120-468-121	0-120-468-123	0-120-468-125	0-120-468-126	0-120-469-002	0-120-469-003
0-120-469-011	0-120-469-012	0-120-469-016	0-120-469-017	0-120-469-588	0-120-469-589
0-120-469-590	0-120-469-591	0-120-469-642	0-120-469-648	0-120-469-649	0-120-469-676
0-120-469-677	0-120-469-689	0-120-469-690	0-120-469-709	0-120-469-725	0-120-469-726
0-120-469-727	0-120-469-728	0-120-469-729	0-120-469-730	0-120-469-731	0-120-469-732
0-120-469-733	0-120-469-742	0-120-469-743	0-120-469-744	0-120-469-745	0-120-469-746
0-120-469-768	0-120-469-777	0-120-469-778	0-120-469-779	0-120-469-780	0-120-469-782
0-120-469-783	0-120-469-790	0-120-469-801	0-120-469-802	0-120-469-804	0-120-469-805
0-120-469-806	0-120-469-808	0-120-469-809	0-120-469-810	0-120-469-926	0-120-469-927
0-120-469-928	0-120-469-941	0-120-469-942	0-120-469-943	0-120-469-946	0-120-469-947
0-120-469-948	0-120-469-949	0-120-469-950	0-120-469-962	0-120-469-970	0-120-469-971
0-120-469-972	0-120-469-992	0-120-469-993	0-120-469-995	0-120-469-996	0-120-469-997
0-120-469-998	0-120-496-777	0-986-033-150	0-986-033-710	0-986-034-020	0-986-034-030
0-986-035-820	0-986-036-350	0-986-036-360	0-986-036-660	0-986-037-040	0-986-038-220
0-986-038-300	0-986-038-340				

RB-55H

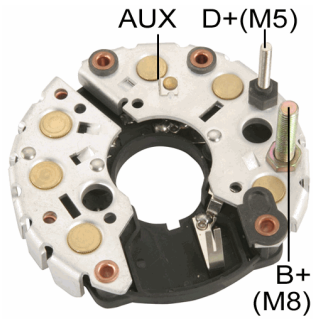

*120mm OD
*6-35 Amp Diodes

Replaces

BMW :

12311288457

BOSCH :

1-127-320-702 1-127-320-709 1-127-320-722

OPEL :

1205455 90349855

VOLVO/DAF :

9130095

Unit no.

BOSCH

0-120-469-618	0-120-469-619	0-120-469-641	0-120-469-667	0-120-469-683	0-120-469-684
0-120-469-685	0-120-469-757	0-120-469-758	0-120-469-759	0-120-469-794	0-120-469-795
0-120-469-799	0-120-469-800	0-120-469-881	0-120-496-617	0-986-034-080	0-986-034-110
0-986-034-170					

RB-56H

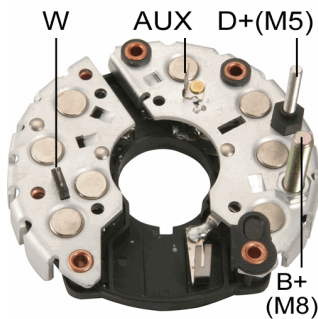

*120mm OD
*8-35 Amp Diodes

Replaces

AUDI/VW :

75903359

BOSCH :

1-127-320-708 1-127-320-731

LUCAS :

UBB432

MAGNETI MARELLI :

940038206

MERCEDES-BENZ :

1547916

Unit no.

BOSCH

0-120-469-015	0-120-469-020	0-120-469-021	0-120-469-663	0-120-469-722	0-120-469-723
0-120-469-724	0-120-469-734	0-120-469-735	0-120-469-736	0-120-469-737	0-120-469-738
0-120-469-739	0-120-469-740	0-120-469-741	0-120-469-774	0-120-469-813	0-120-469-814
0-120-469-856	0-120-469-857	0-120-469-863	0-120-469-884	0-120-469-903	0-120-469-904
0-120-469-908	0-120-469-929	0-120-469-930	0-120-469-931	0-120-469-932	0-120-469-933
0-120-469-934	0-120-469-953	0-120-469-975	0-120-469-976	0-120-469-977	0-120-469-991

RB-57H

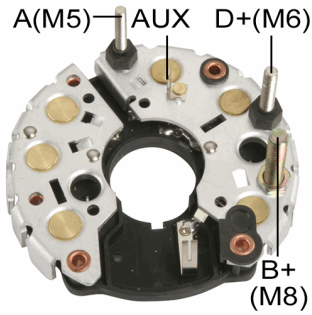

*120mm OD
*6-35 Amp Diodes

Replaces

BOSCH :

1-127-320-707

FORD :

6153349 85GB-1034BA

Unit no.

BOSCH

0-120-469-655	0-120-469-656	0-120-469-657	0-120-469-658	0-120-469-781	0-986-034-010
0-986-036-050	0-986-037-010				

RB-58H

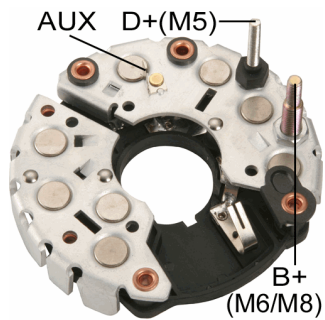

*120mm OD
*8-35 Amp Diodes

Replaces

BOSCH :

1-127-320-712 1-127-320-735

Unit no.

BOSCH

0-120-469-784	0-120-469-785	0-120-469-786	0-120-469-787	0-120-469-793	0-120-469-838
0-120-469-882	0-120-469-883	0-120-469-910	0-120-469-915	0-120-469-916	0-120-469-924
0-120-469-935					

RB-59H

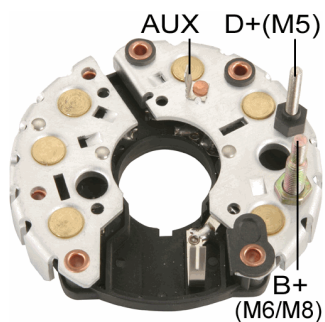

*120mm OD
*6-35 Amp Diodes

Replaces

BOSCH :

1-127-320-713

VOLVO/DAF :

1398640

Unit no.

BOSCH

0-120-468-009	0-120-468-010	0-120-468-011	0-120-468-012	0-120-468-015	0-120-468-016
---------------	---------------	---------------	---------------	---------------	---------------

RB-60H

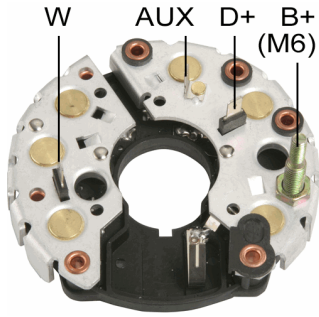

*120mm OD
*6-35 Amp Diodes

Replaces

BOSCH :
1-127-320-711
VOLVO/DAF :
1363741

Unit no.

BOSCH
0-120-469-750 0-120-469-751 0-986-034-690

RB-61H

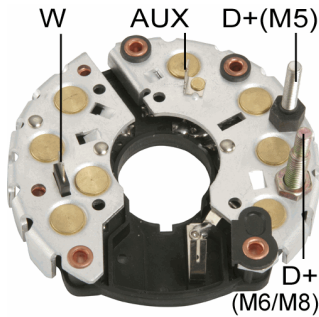

*120mm OD
*8-35 Amp Diodes

Replaces

BOSCH :
1-127-320-716
VOLVO/DAF :
3515707

Unit no.

BOSCH
0-120-469-787 0-120-469-788 0-120-469-789

RB-62H

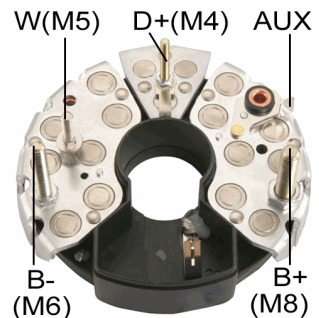

*120mm OD
*14-35 Amp Diodes

Replaces

BOSCH :
1-127-320-390 1-127-320-959

Unit no.

BOSCH
0-120-469-014 0-120-469-522

RB-63H

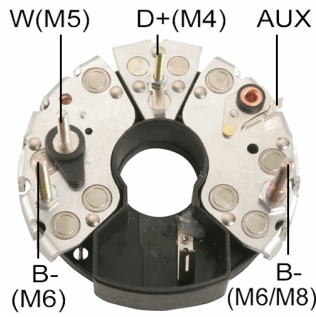

*120mm OD
*8-35 Amp Diodes

Replaces

BOSCH :

1-127-320-590 1-127-320-977

Unit no.

BOSCH

0-120-469-549 0-120-469-569 0-120-469-643 0-120-469-679

RB-66H

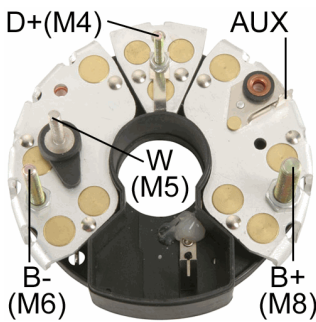

*120mm OD
*8-50A Avalanche Diodes

Replaces

BOSCH :

1-127-320-602 1-127-320-924 1-127-320-951 1-127-320-955 1-127-320-980 1-127-320-981

MAN :

81261090016

VOLVO :

1698182

Unit no.

BOSCH

0-120-468-037 0-120-488-208 0-120-488-273 0-986-037-760

RB-67H

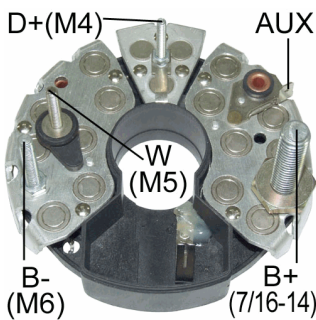

*120mm OD
*14-50A Avalanche Diode

Replaces

BOSCH :

1-127-320-954

Unit no.

BOSCH

0-120-468-028 0-120-468-055

RB-67HA

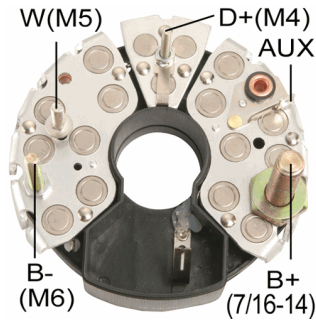

* 120mm OD
* 14-50 Amp Diode

Replaces

BOSCH :
1-127-320-920

Unit no.

BOSCH
0-120-468-028 0-120-468-055

RB-71H

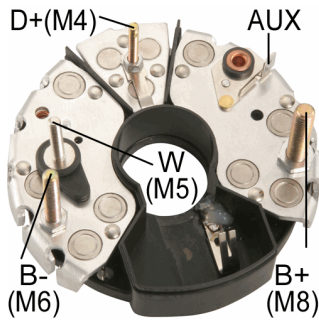

*120mm OD
*8-50A Avalanche Diodes

Replaces

BOSCH :
1-127-320-928 1-127-320-946 1-127-320-956 1-127-320-969 1-127-320-970 1-127-320-971
1-127-320-989 1-127-320-990

IVECO :
93160252

KHD :
1318310

MAN :
81261090018

VOLVO :
3090260 3090262 68132

Unit no.

BOSCH
0-120-465-010 0-120-468-107 0-120-468-113 0-120-468-114 0-120-468-124 0-120-468-131
0-120-468-137 0-120-469-008 0-120-469-010 0-120-469-019 0-120-469-022 0-120-469-023
0-120-469-025 0-120-469-026 0-120-469-027 0-120-469-030 0-120-469-031 0-120-469-891
0-120-469-978 0-120-469-999 0-986-030-520 0-986-034-420 0-986-036-920

RB-72H

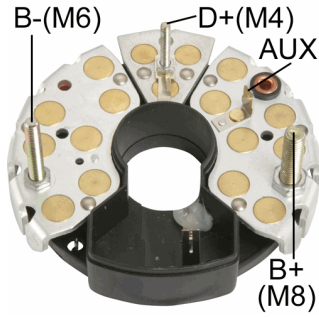

*120mm OD
*14-35 Amp Diodes

Replaces

AUDI/VW :

049903359D

BOSCH :

1-127-320-361	1-127-320-379	1-127-320-386	1-127-320-388	1-127-320-395	1-127-320-543
1-127-320-653	1-127-320-654	1-127-320-655	1-127-320-656		

FORD :

613319 83DB-10304AA

LUCAS :

UBB434

VOLVO :

244610 698121

Unit no.

BOSCH

0-120-450-010	0-120-450-015	0-120-468-065	0-120-469-518	0-120-469-519	0-120-469-520
0-120-469-521	0-120-469-522	0-120-469-523	0-120-469-526	0-120-469-527	0-120-469-532
0-120-469-540	0-120-469-562	0-120-469-569	0-120-469-579	0-120-469-580	0-120-469-629
0-120-469-630	0-120-469-653	0-120-469-692	0-120-469-749	0-120-469-752	0-120-469-753
0-120-469-761	0-120-469-763	0-120-469-772	0-120-469-773	0-120-469-797	0-120-469-798
0-120-469-807	0-120-469-843	0-120-469-850	0-120-469-851	0-120-469-852	0-120-469-853
0-120-469-854	0-120-469-855	0-120-469-900	0-120-469-905	0-120-469-951	0-120-469-952
0-120-469-955	0-120-469-959	0-120-469-960	0-120-471-979	0-986-032-720	0-986-033-100
0-986-033-530	0-986-033-840	0-986-034-070	0-986-034-360	0-986-034-370	0-986-034-430
0-986-036-240					

RB-73H

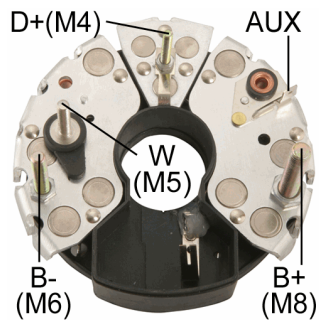

*122mm OD
*M5 W Post
*8-35 Amp Diodes

Replaces

BOSCH :

1127320961	1127320388	1127320390	1127320395	1127320653	1127320654
1127320655	1127320656	1127320928	1127320946	1127320959	1127320960
1127320961	1127320969	1127320995	1127320361		

RENAULT :

1127320960

Unit no.

BOSCH

0-120-450-015	0-120-468-518	0-120-469-038	0-120-469-519	0-120-469-520	0-120-469-521
0-120-469-523	0-120-469-562	0-120-469-579	0-120-469-585	0-120-469-592	0-120-469-652
0-120-469-653	0-120-469-692	0-120-469-752	0-120-469-761	0-120-469-763	0-120-469-772
0-120-469-797	0-120-469-798	0-120-469-807	0-120-469-850	0-120-469-851	0-120-469-854
0-120-469-855	0-120-469-920	0-120-469-959	0-120-469-960		

RB-74H

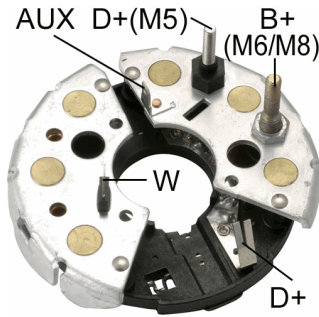

*114mm OD
*6-50A Avalanche Diode

Replaces

BOSCH :
1-127-319-104

Unit no.

BOSCH
0-120-488-283

RB-75H

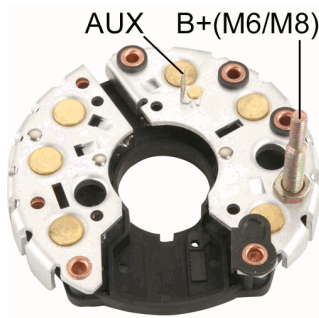

*120mm OD
*M6 Battery Post
*6-35 Amp Diodes

Replaces

BOSCH :
1-127-320-718 1-127-320-719

Unit no.

BOSCH
0-120-450-012 0-120-450-014 0-120-450-016 0-120-450-017

RB-77H

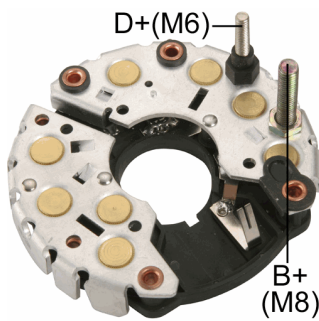

*120mm OD
*8-35 Amp Diodes

Replaces

BOSCH :
1-127-320-720 1-127-320-741 1-127-320-911

Unit no.

BOSCH
0-120-468-007 0-120-468-008 0-120-468-030 0-120-468-031 0-120-468-050 0-120-468-051
0-120-468-067 0-120-468-095 0-120-468-096 0-120-469-775 0-120-469-776 0-120-469-989
0-120-469-990 0-986-035-730 0-986-035-810

RB-78H

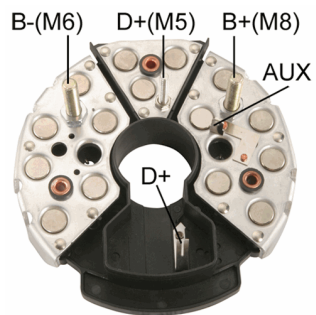

- *145mm OD
- *M8 Battery Post
- *12-50A Avalanche Diodes

Replaces

BOSCH :

1-127-320-973

IVECO :

93163820

KHD :

1319100

MERCEDES-BENZ :

0011540816

SCANIA :

1347012

VOLVO :

3097306

Unit no.

BOSCH

0-120-689-533	0-120-689-534	0-120-689-535	0-120-689-538	0-120-689-539	0-120-689-540
0-120-689-541	0-120-689-542	0-120-689-543	0-120-689-545	0-120-689-546	0-120-689-549
0-120-689-550	0-120-689-551	0-120-689-552	0-120-689-553	0-120-689-555	0-120-689-557
0-120-689-558	0-120-689-559	0-120-689-561	0-120-689-562	0-120-689-563	0-120-689-564
0-120-689-566	0-120-689-567	0-120-689-569	0-120-689-570	0-120-689-571	0-120-689-572
0-120-689-573	0-120-689-574	0-120-689-575	0-120-689-576	0-120-689-577	0-120-689-582
0-120-689-583	0-120-689-584				

RB-78HA

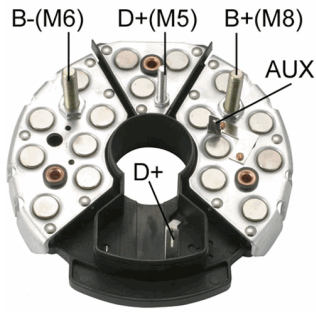

- *145mm OD
- *14-35 Amp Diodes
- *With W terminal

Replaces

BOSCH :

1-127-320-547 1-127-320-550 1-127-320-571

IVECO :

8122274

KHD :

1320547

MAGIRUS-DEUTZ :

1309660

MERCEDES-BENZ :

0001545116 0001545416

SAAB :

424968

VOLVO :

1698762 696002

Unit no.

BOSCH

0-120-489-503	0-120-505-010	0-120-689-503	0-120-689-504	0-120-689-505	0-120-689-506
0-120-689-507	0-120-689-508	0-120-689-510	0-120-689-511	0-120-689-512	0-120-689-513
0-120-689-514	0-120-689-515	0-120-689-516	0-120-689-517	0-120-689-520	0-120-689-521
0-120-689-522	0-120-689-523	0-120-689-524	0-120-689-525	0-120-689-526	0-120-689-527
0-120-689-528	0-120-689-530	0-120-689-532	0-120-689-623	0-986-031-600	0-986-033-520
0-986-033-550	0-986-034-600	0-986-034-610	0-986-034-910		

RB-79H

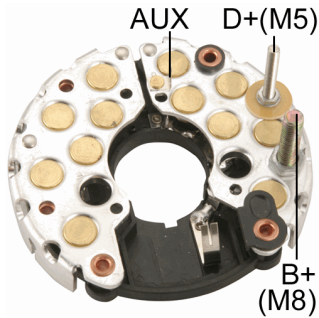

- *120mm OD
- *12-35 Amp Diodes
- *With Anti Feed Back Diode

Replaces

BOSCH :

1-127-320-607

Unit no.

BOSCH

0-120-469-621	0-120-469-622	0-120-469-639	0-120-469-640
---------------	---------------	---------------	---------------

RB-80H

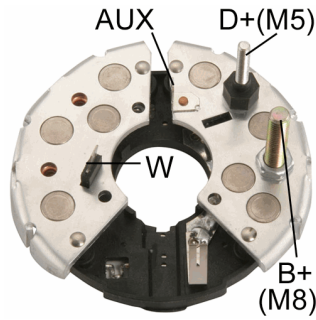

*114mm OD
 *8-50A Avalanche Diode(19~24V)

Replaces

BOSCH :
 1127320692

Unit no.

BOSCH
 0-120-484-001 0-120-484-011 0-120-484-012 0-120-484-015 0-120-484-018 0-120-484-020
 0-120-484-022 0-120-484-024

RB-80HA

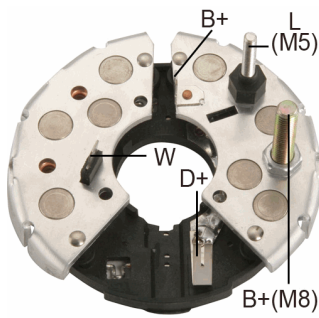

*114mm OD
 *8-50A Avalanche Diodes(32~40V)

Replaces

BOSCH :
 9-122-067-305

RB-81H

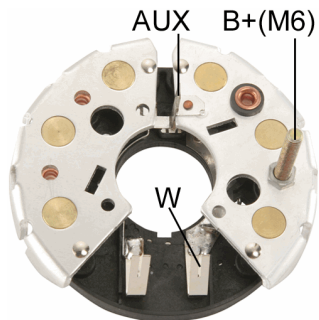

*114mm OD
 *6-50A Avalanche Diode

Replaces

BOSCH :
 9-121-067-379

Unit no.

BOSCH
 9-120-060-027

RB-82H

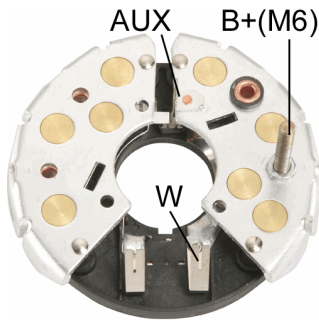

*114mm OD
*8-35 Amp Diodes

Replaces

FORD :
E9YJ-10304A

Unit no.

BOSCH
9-120-060-020
FORD
E9YJ-10346A

RB-83H

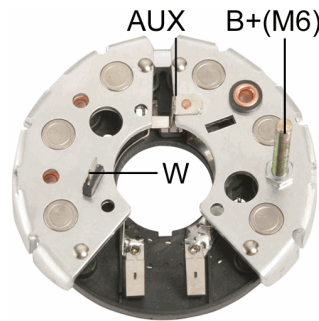

*114mm OD
*6-50A Avalanche Diodes

Unit no.

BOSCH
9-120-067-027

RB-84H

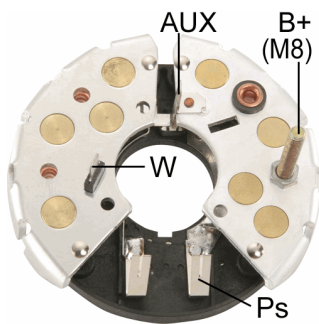

*114mm OD
*8-50A Avalanche Diodes

Replaces

BOSCH :
9121067067 9121067364 9121067371 9121067374 9121067375 9121067388
9121067394

Unit no.

BOSCH
9-120-060-009 9-120-060-023 9-120-060-027

RB-85H

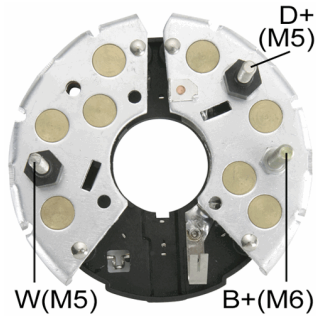

- *114mm OD
- *M6 Battery Post
- *8-35 Amp Diodes

Replaces

BOSCH :
9-128-040-953J

Unit no.

BOSCH
9-120-180-020J

RB-86H

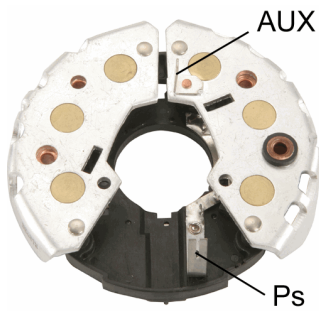

- *114mm OD
- *6-35 Amp Diodes

Replaces

BOSCH :
1-127-320-903

Unit no.

BOSCH
 0-120-488-146 0-120-488-147 0-120-488-148 0-120-488-149 0-120-488-150 0-120-488-179
 0-120-488-180 0-120-488-181 0-120-488-243

RB-87H

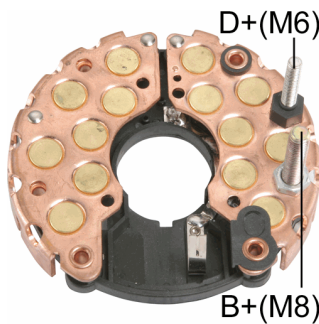

- *120mm OD
- *14-35 Amp Diodes

Replaces

BOSCH :
1-127-320-901 1-127-320-912 1-127-320-918 1-127-320-938

Unit no.

BOSCH
 0-100-468-074 0-120-468-013 0-120-468-014 0-120-468-032 0-120-468-048 0-120-468-049
 0-120-468-071 0-120-468-072 0-120-468-073 0-120-468-097 0-120-468-098

RB-88H

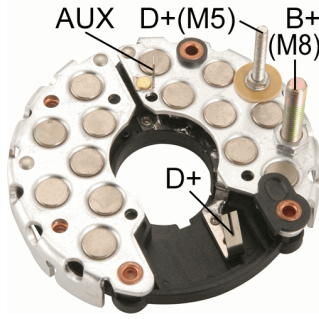

- *120mm OD
- *M8 Battery Post
- *14-35 Amp Diodes

Replaces

BOSCH :
1-127-320-737

Unit no.

BOSCH
0-120-468-004

RB-91H

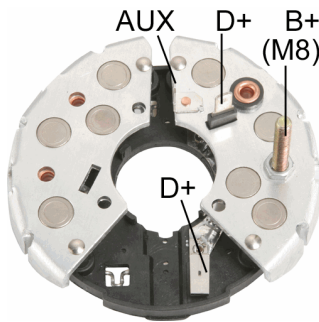

- *114mm OD
- *8-50A Avalanche Diode

Replaces

BOSCH :
1-127-320-906

Unit no.

BOSCH
0-120-484-004 0-120-484-005 0-120-484-006 0-120-484-009 0-120-484-010 0-120-484-013
0-120-484-014

RB-926H

Heat Sink(+)
(Top)

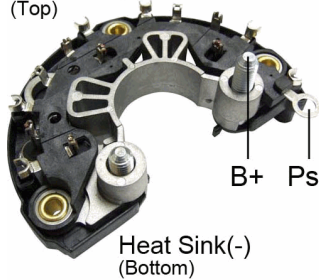

- *118mm OD
- *6-50A Avalanche Diodes
- *Y connection
- *Replace to part number RB-126H

Replaces

AUDI/VW :
038903359D

BOSCH :
F-00M-123-226 F-00M-123-229

MEC(OLD) :
RB-126H

Unit no.

BOSCH
0-124-325-050 0-124-325-051

Used On

VOLKSWAGEN
Lupo 1.4FSI 2001-2005

RB-929H

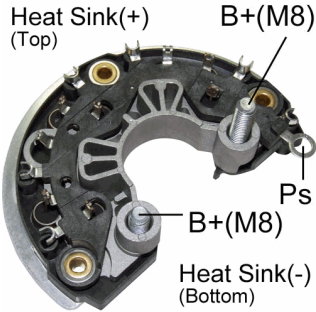

- *M8 Battery Post
- *130mm OD
- *Delta connection
- *6-50A Avalanche Diodes
- *Replace to part number RB-129H

Replaces

BOSCH :

F00M133215 F00M133218 F00M133247 F00M133259 F00M133229 F00M133204
 F00M133214 F00M133249

MEC(OLD) :

RB-129H

Unit no.

BOSCH
 6-004-ML0-017 6-004-ML0-021

RB-929HV

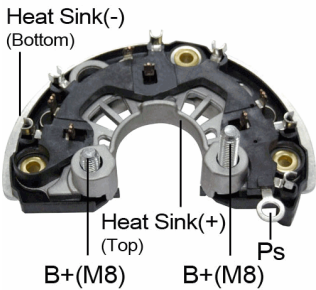

- *M8 Battery Post
- *130mm OD
- *Delta connection
- *6-70A Avalanche Diodes
- *Replace to part number RB-129HV

Replaces

BOSCH :

F-00M-133-215 F-00M-133-218 F-00M-133-247 F-00M-133-259 F-00M-133-229

MEC(OLD) :

RB-129HV

Unit no.

BOSCH
 6-004-ML0-017 6-004-ML0-021

RB-92H

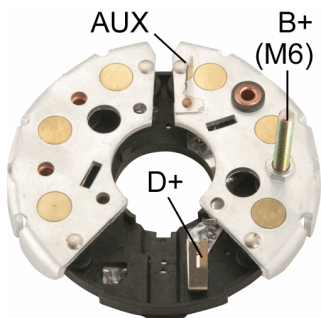

- *114mm OD
- *6-50A Avalanche Diode

Replaces

BOSCH :

9-122-337-307

Unit no.

BOSCH
 9-120-334-631 9-120-334-632

RB-93H

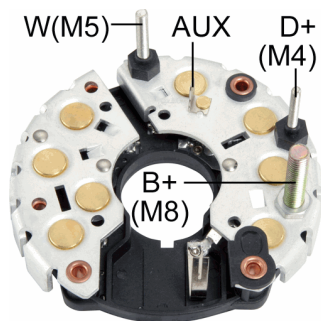

*120mm OD
*8-50A Avalanche Diodes

Replaces

BOSCH :

1127320753 1127320750

DAF :

132114

IVECO :

42531816

MERCEDES-BENZ :

0005481416 0011542216

Unit no.

BOSCH

0 120 468 143 0 120 468 145 0 120 469 101 0 120 469 107 0 120 469 108 0 120 469 109

0 120 469 110 0 120 469 111 0 120 469 112 0 120 469 113 0 120 469 114 0 120 469 115

0 120 469 116 0-120-469-100 0-120-469-102 0-120-469-103

MERCEDES-BENZ

0101549102 0101549202

RB-952H

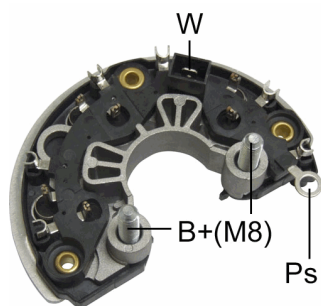

*130mm OD
*M8 Battery Post
*6-50 Avalanche Diodes
*Replace to part number RB-152H

Replaces

BOSCH :

F-00M-133-269

MEC(OLD) :

RB-152H

RB-954H

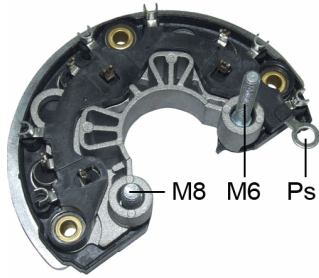

- *130mm OD
- *M6 Battery Post
- *6-70A Avalanche Diodes
- *Replace to part number RB-154H

Replaces

BOSCH :
F-00M-133-277
MEC(OLD) :
RB-154H

Unit no.

BOSCH
0-124-525-072

RB-96H

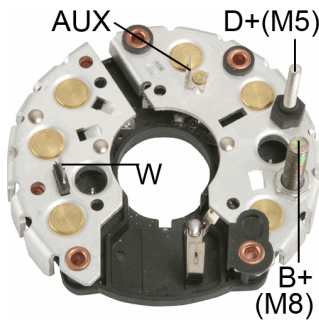

- *120mm OD
- *6-35 Amp Diodes

Replaces

BOSCH :
1-127-320-743

Unit no.

BOSCH
0-120-468-080 0-120-468-081 0-120-468-084 0-120-468-085 0-120-468-086 0-120-468-119
0-120-468-120

RB-97H

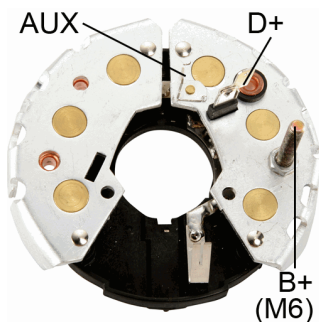

- *114mm OD
- *6-35 Amp Diodes

Replaces

BOSCH :
9-122-337-303

Unit no.

BOSCH
9-120-334-317 9-120-334-318

RC-19

Heat Sink(+)
Top

*3-50 Amp Diodes
*Without Terminal



Heat Sink(-)
Bottom

Replaces

CHRYSLER :

4364855 4467162 5226009

RC-21N

Heat Sink (-)

*Negative
*3-25 Amp Diodes

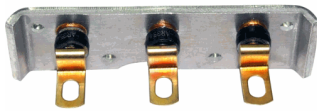

Replaces

CHRYSLER :

3438721 3755114

RC-21P

Heat Sink(+)

*Positive
*3-25 Amp Diodes

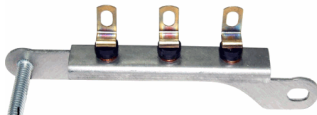

B+ (1/4-20uNC)

Replaces

CHRYSLER :

3438727 3874268 3874269 3874343 4026082 4026083
4026282 4240488

RD-16

*8-50 Amp Diodes

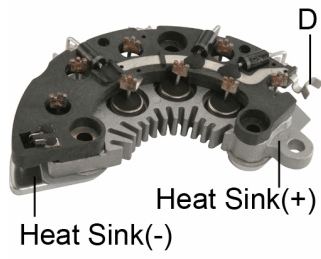

Replaces

DAEWOO :

262100	267000	276000
--------	--------	--------

RD-32

*6-50A Avalanche Diodes

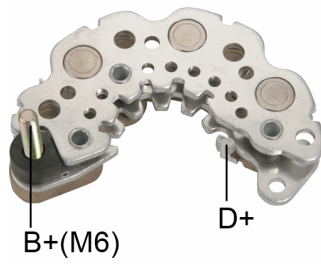

Unit no.

DAEWOO

219170	96380673	266000
--------	----------	--------

DELCO

19020601	19020609	19020611	19020612
----------	----------	----------	----------

RD-04B

*O.E. TYPE with 6-50A Avalanche Diodes

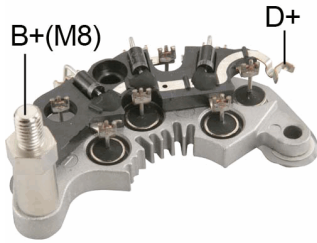

Replaces

DELCO :

10475034	1205464	589714	10475034
----------	---------	--------	----------

Unit no.

DELCO

10479914	10479923	10479947	10479955	3493947
----------	----------	----------	----------	---------

RD-05

*6-50 Amp Diodes
*Wide Fin Gull Wing Style Heat Sinks

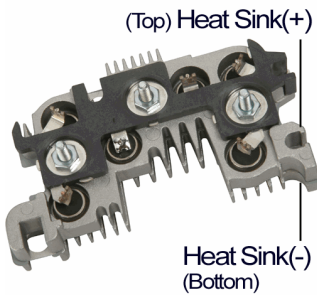

Replaces

DELCO :

1988976	D3987
---------	-------

Unit no.

DELCO

1105585	1105680	1105683	1105690	1117880	1117894
1117910	1117923	1117953	1117956	19010105	

RD-06

*6-50A Avalanche Diodes
*Wide Fin Gull Wing Style Heat Sink
*For use on 21SI, CS144 100A Alternators

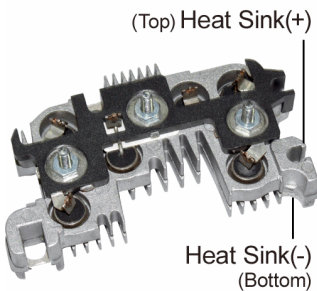

Replaces

BOSCH :

111233	111240
--------	--------

DELCO :

10469265	D3929
----------	-------

Unit no.

DELCO

1117886	1117892	1117937
---------	---------	---------

RD-06A

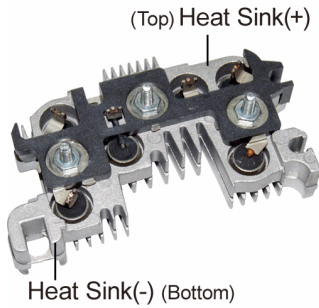

- *3-50A Diodes, 3-50A Avalanche diodes
- *Wide Fin Gull Wing Style Heat Sinks
- *For use on 21SI, CS144 100A Alternators

Replaces

DELCO :

10471170	1989774	10467052	10470609	D3990	D3992
D3931					

Unit no.

DELCO					
1117895	1117903	1117927	1117932	1117957	1117958
1117959					

RD-06B

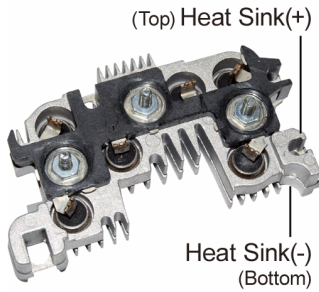

- *6-50A Avalanche Diodes
- *Wide Fin Gull Wing Style Heat Sink
- *Heavy Duty Version of RD-06 for use on 21SI, CS144 120A Alternators

RD-07

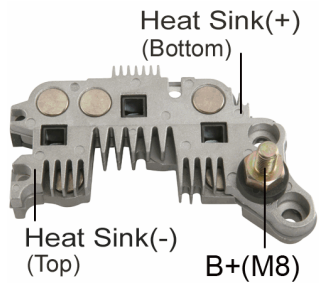

- *6-50A Avalanche Diodes
- *Wide Fin Gull Wing Style Heat Sinks
- *CS144 Alternators

Replaces

DELCO :

10475800

Unit no.

DELCO			
10479891	10479966	10480010	1102625

RD-08

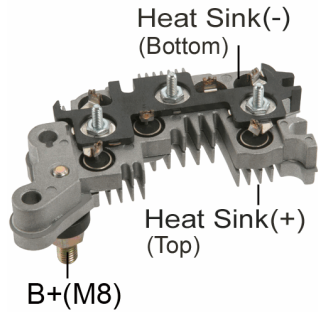

- *6-50A Avalanche Diodes
- *Wide Fin Gull Wing Style Heat Sinks
- *CS144 Alternators

Replaces

DELCO :
10472095

Unit no.

DELCO

104080200	10479821	10479852	10479891	10479966	10479995
1048008	10480111	10480139	1101580	1101850	1102625

RD-09

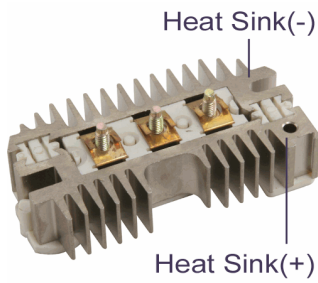

- *6-25 Amp Diodes
- *10SI,20SI,30SI Series
- *Negative Ground Version of RD-30
- *(RD-30 is Positive Ground Version.)

Replaces

DELCO :

1852209	1875627	1891055	1971987	1984638	D3915
---------	---------	---------	---------	---------	-------

Unit no.

DELCO

1100499	1102916	1102921	1102934	1102935	1103116
1103123	1103129	1103190			

RD-09H

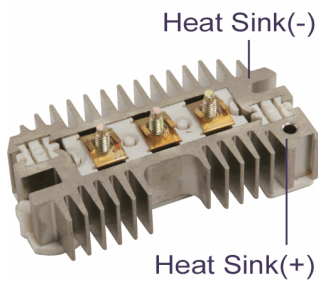

- *6-35 Amp Diodes
- *For DELCO 10SI, 20SI, 30SI alternators
- *Negative Ground Version of RD-30H
- *(RD-30H is Positive Ground Version.)
- *Economy Version: RD-09HA

Replaces

DELCO :

1852209	1875627	1891055	1971987	1984638	D3915
---------	---------	---------	---------	---------	-------

Unit no.

DELCO

1100499	1102916	1102921	1102934	1102935	1103116
1103123	1103129	1103190			

RD-10

*6-25 Amp Diodes

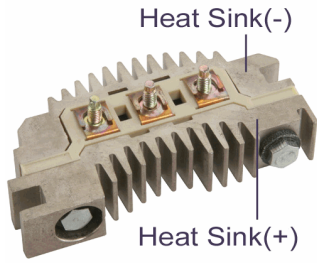

Replaces

DELCO :

3472311	7982716	7982718	DR1000
---------	---------	---------	--------

Unit no.

DELCO

3472002	3472004	3472008	3472014	3472018	3472022
3472023	3472024	3472025	3472026	3472027	3472028
3472032	3472033	3472037	3472038		

RD-10H

*6-35 Amp Diodes

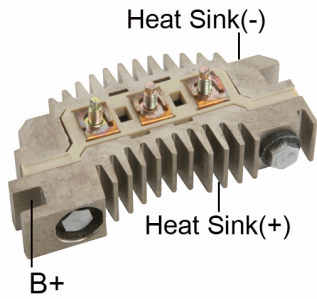

Replaces

DELCO :

3472311	7982716	7982718	DR3900
---------	---------	---------	--------

RD-10HV

*6-50 Amp Diodes

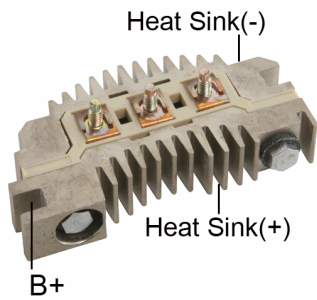

Replaces

DELCO :

7332312

Unit no.

DELCO

3027014	3720002	3720004	3720008	3720018	3720022
3720023	3720024	3720026	3720027	3720028	3720032
3720037					

RD-11

*6-25 Amp Diodes

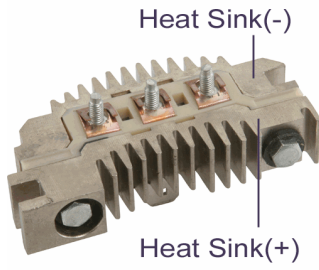

Replaces

DELCO :

7982623	7982659	7982756	7982772
---------	---------	---------	---------

Unit no.

DELCO

7892744	7982574	7982575	7982600	7982601	7982604
7982605	7982645	7982648	7982652	7982657	7982674
7982698	7982699	7982703	7982704	7982705	7982707
7982710	7982717	7982720	7982721	7982728	7982738
7982739	7982740	7982741	7982742	7982743	7982744
7982745	7982747	7982748	7982749	7982750	7982752
7982753	7982758	7982759	7982762	7982766	7982778
7982787	7982811	7982812	7982822	7982854	7982856
7982857	7982864	7982865	7982872	7982873	7982874
7982875	7982952	7982953	7982981	7982986	7982988

RD-11H

*6-35 Amp Diodes

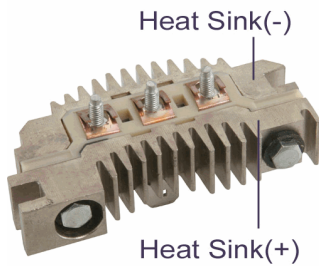

Replaces

DELCO :

7982623	7982659	7982756	7982772
---------	---------	---------	---------

VW/BRAZIL :

31-127

RD-12

*6-25 Amp Diodes
*12SI Series

Heat Sink(-)

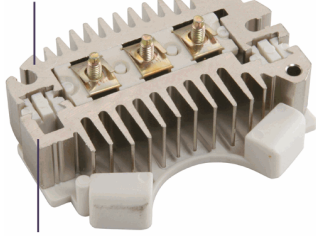

Heat Sink(+)

Replaces

DELCO :

1984454 D3924

Unit no.

DELCO

1100200	1100207	1100208	1100240	1100241	1100242
1100258	1101285	1101439	1101440	1105367	1105440
1105536	1105538				

RD-12H

*6-35 Amp Diodes
*For DELCO 12SI alternators
*Economy Version: RD-12HA

Heat Sink(-)

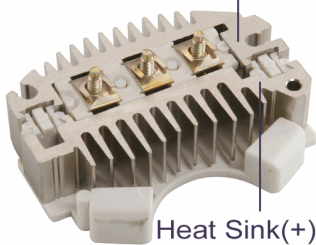

Heat Sink(+)

Replaces

DELCO :

1984454 D3924

Unit no.

DELCO

1100200	1100207	1100208	1100240	1100241	1100242
1100258	1101285	1101439	1101440	1105367	1105440
1105536	1105538				

RD-13HV

*6-50 Amp Diodes
*For 12SI Alternators

Heat Sink(-)

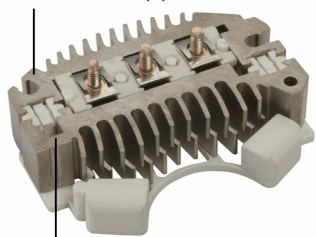

Heat Sink(+)

Replaces

DELCO :

1987061 D3986

Unit no.

DELCO

1005425	1005428	1005493	1105425	1105428	1105493
---------	---------	---------	---------	---------	---------

RD-14

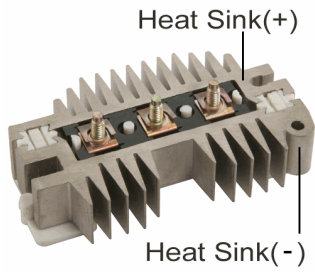

- *6-25 Amp Diodes
- *15SI 70-85 Amp Series
- *Positive Ground Version
- *(RD-31 is Negative Ground Version)

Replaces

DELCO :
1975313 D3919

Unit no.

DELCO					
1100184	1100190	1100192	1101077	1101096	1101438
1101446					

RD-14H

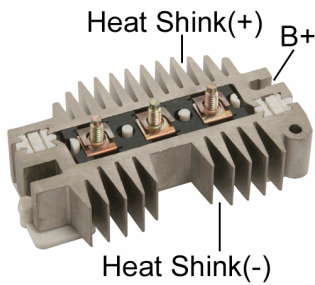

- *6-35 Amp Diodes
- *15SI 70-85 Amp Series
- *Positive Ground Version
- *(RD-31H is Negative Ground Version.)
- *Economy Version: RD-14HA

Replaces

DELCO :
1975313 D3919

Unit no.

DELCO					
1100184	1100190	1100192	1101077	1101096	1101438
1101446					

RD-15

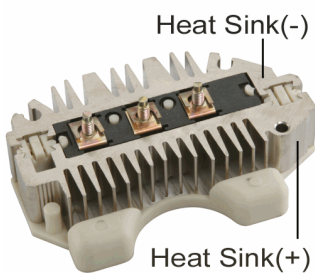

- *6-25 Amp Diodes
- *6 Pos. & 3 Neg. Diodes
- *17SI 97-108 Amp

Replaces

DELCO :
1985801 D3985

Unit no.

DELCO				
1105085	1105450	1105451	1105491	1105513

RD-15H

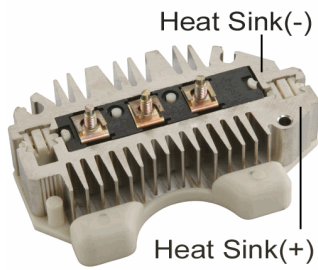

- *6-35 Amp Diodes
- *6 Pos. & 3 Neg. Diodes
- *17SI 97-108 Amp
- *Economy Version: RD-15HA

Replaces

DELCO :

1985801 D3985

Unit no.

DELCO

1105085 1105450 1105451 1105491 1105513

RD-17

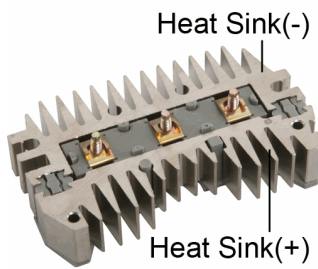

- *6-25 Amp Diodes
- *27SI, Type 100,200,29SI,30SI Negative Ground Alternators

Replaces

DELCO :

1875645 1892914 801816 D3982 D3983

Unit no.

DELCO

1100077 1100078 1100080 1100095 1100177 1101015
 1101016 1101018 1101020 1101091 1101450 1101550
 1105472 1105477 1117160 1117163 1117732 1117801
 1117805 1117807 1117818

RD-17H

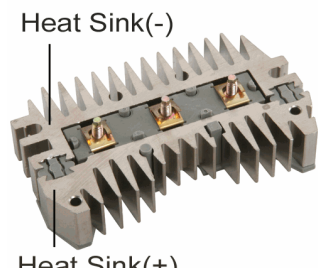

- *6-35 Amp Diodes
- *27SI Type 100,200,29SI,30SI Negative Ground Alternators
- *Economy Version: RD-17HA

Replaces

CATERPILLAR :

9L6776

DELCO :

1875645 1892914 801816 D3982 D3983 1975645

Unit no.

DELCO

1100077 1100078 1100080 1100095 1100177 1101015
 1101016 1101018 1101020 1101091 1101450 1101550
 1105472 1105477 1117160 1117163 1117732 1117801
 1117805 1117807 1117818

RD-18

*6-25 Amp Diodes
 *Economy Version: RD-18HA

Heat Sink(-)

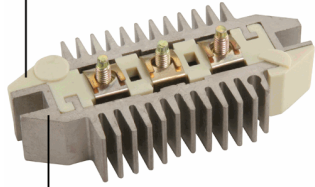

Heat Sink(+)

Replaces

DELCO :					
3472813	3493714	3493721	6065301		
OPEL :					
1205409					

Unit no.

DELCO					
3472057	3472058	3472059	3472060	3472061	3472062
3472065	3472066	3472067	3472068	73472813	
OPEL					
1204012	1204013	1204015	1204018	1204020	1204021
1204040	1204042	1204043	1204045	1204068	1204088
1204095	1204109	1204112	1204121	1204203	1204217

RD-18H

*6-35 Amp Diodes
 *Economy Version: RD-18HA

Heat Sink(-)

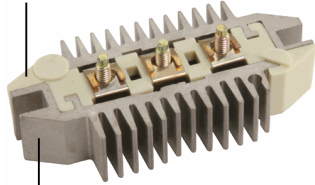

Heat Sink(+)

Replaces

DELCO :					
3472813	3493714	3493721	6065301		
OPEL :					
1205409					

Unit no.

DELCO					
3472057	3472058	3472059	3472060	3472061	3472062
3472065	3472066	3472067	3472068		
OPEL					
1204012	1204013	1204015	1204018	1204020	1204021
1204040	1204043	1204045	1204068	1204088	1204095
1204109	1204112	1204121	1204203	1204217	

RD-19

*6-25 Amp Diodes

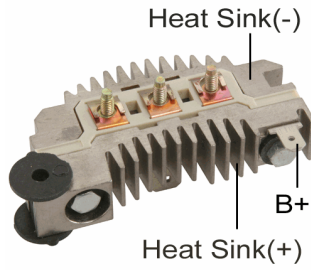

Replaces

DELCO :

7982623	7982659	7982756	7982772	7982888
---------	---------	---------	---------	---------

Unit no.

DELCO

7892744	7982574	7982575	7982600	7982601	7982604
7982605	7982645	7982648	7982652	7982657	7982674
7982698	7982699	7982703	7982704	7982705	7982707
7982710	7982717	7982720	7982721	7982728	7982738
7982739	7982740	7982741	7982742	7982743	7982744
7982745	7982747	7982748	7982749	7982750	7982752
7982753	7982758	7982759	7982762	7982766	7982778
7982787	7982811	7982812	7982822	7982854	7982856
7982857	7982864	7982865	7982872	7982873	7982874
7982875	7982952	7982953	7982981	7982986	7982988

RD-19H

*6-35 Amp Diodes

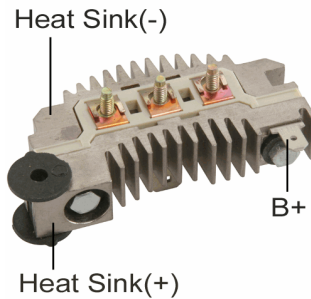

Replaces

DELCO :

7982623	7982659	7982756	7982772	7982888
---------	---------	---------	---------	---------

Unit no.

DELCO

7892744	7982574	7982575	7982600	7982601	7982604
7982605	7982645	7982648	7982652	7982657	7982674
7982698	7982699	7982703	7982704	7982705	7982707
7982710	7982717	7982720	7982721	7982728	7982738
7982739	7982740	7982741	7982742	7982743	7982744
7982745	7982747	7982748	7982749	7982750	7982752
7982753	7982758	7982759	7982762	7982766	7982778
7982787	7982811	7982812	7982822	7982854	7982856
7982857	7982864	7982865	7982872	7982873	7982874
7982875	7982953	7982981	7982986	7982988	

RD-20

*6-25 Amp Diodes

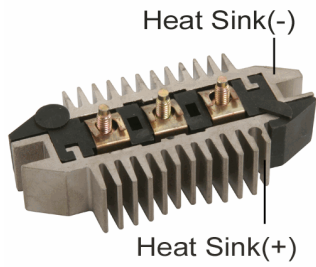

Replaces

DELCO :			
3493008	3493716	3493717	34937417
OPEL :			
1205454			

Unit no.

DELCO					
3742106	3742121	3742130	3742134	3742137	3742144
OPEL					
1204100	1204131	1204219			

RD-20H

*6-35 Amp Diodes
*Economy Version: RD-20HA

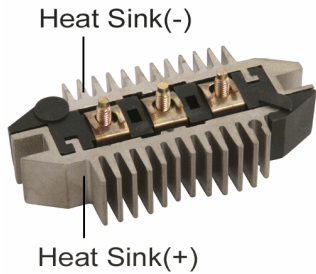

Replaces

DELCO :			
3493008	3493417	3493716	3493717
OPEL :			
1205454			

Unit no.

DELCO					
3742106	3742121	3742130	3742134	3742137	3742144
OPEL					
1204100	1204131	1204219			

RD-21

*6-25 Amp Diodes

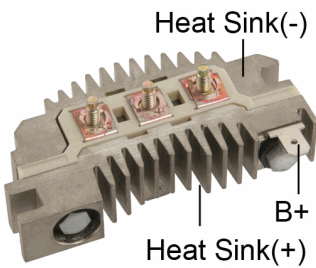

Replaces

DELCO :		
3472820	3478627	3478687

Unit no.

DELCO			
3472020	3472021	3472063	3472064

RD-21H

*6-35 Amp Diodes

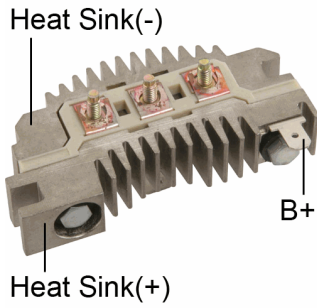

Replaces

DELCO :

3472820 3478627 3478687

Unit no.

DELCO

3472020 3472021 3472063 3472064

RD-22

*6-25 Amp Diodes
*40SI Series

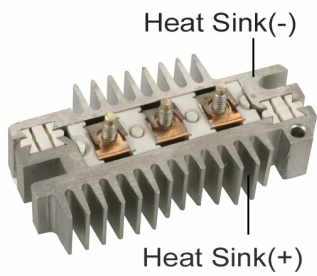

Replaces

DELCO :

1867531

Unit no.

DELCO

1117148

RD-22H

*6-35 Amp Diodes
*40SI Alternators

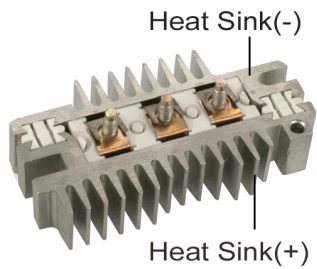

Replaces

DELCO :

1867531

Unit no.

DELCO

1117148

RD-24

*6-25 Amp Diodes
 *27SI TYPE 200&30SI Positive Ground Alternators

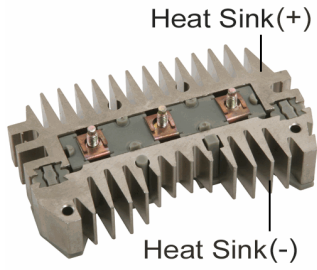

Replaces

CAN :
 130557
DELCO :
 1875812

Unit no.

DELCO
 10463074 1100083 1105471 1117482 1117735 321604

RD-25A

*6-60A Avalanche Diodes

Heat Sink(+) Top



Heat Sink(-) Bottom

Replaces

DELCO :
 10492300

RD-26

*6-50A Avalanche Diodes

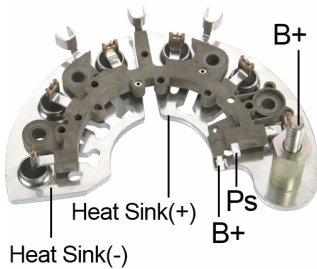

Replaces

DELCO :
 10494744

Unit no.

DELCO
 10480229 10480234 10480241 10480244 10480303 10480326
 10480327 10480341 10480388 10480428

RD-26HD

*6-70A Avalanche Diodes

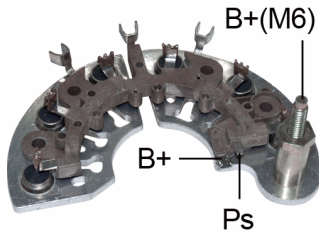

Replaces

DELCO :
10494503

Unit no.

DELCO

10310982	10311493	10464395	10464405	10464406	10464408
10464430	10464440	10464441	10464442	10464443	10464452
10464453	10464456	10464460	10464461	10464466	10464467
10464468	10464469	10464476	10464480	10464482	10464485
10464487	10464488	10464489	10464492	10464493	10480231
10480234	10480244	10480270	10480285	10480298	10480303
10480327	10480341	10480350	10480357	10480368	10480383
10480390	10480414	10480428	10480480	10494492	15056099
15056100	15062413	15087022	15087024	15162839	15750871
15754097	15768830	15769253	15769254	25744162	25744163
25744165					

RD-27H

*6-35 Amp Diodes

*For 25SI Alternators, Negative Ground

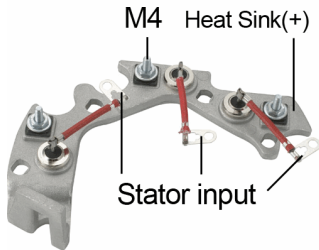

Replaces

DELCO :

1971670 1851437 1969132

VALEO :

593797 2650430

Unit no.

DELCO

10459003	10459006	1117155	1117225	1117226	1117227
1117228	1117231	1117233	1117234		

RD-28H

*6-35 Amp Diodes
 *For 25SI Alternators, Positive Ground

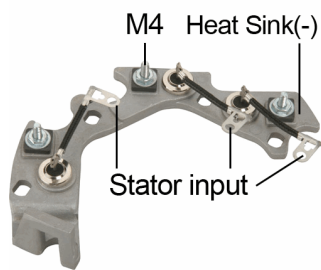

Replaces

DELCO :
 1971867

Unit no.

DELCO
 1117232 1117235 1117245

RD-29

*6-60A Avalanche Diodes



Replaces

DELCO :
 10493596 3472020 3472820 3478687
 OPEL :
 6205432

Unit no.

DELCO
 90543910 UD12AB
 OPEL
 6204072

RD-30

*6-25 Amp Diodes
 *Positive Ground Version of RD-09

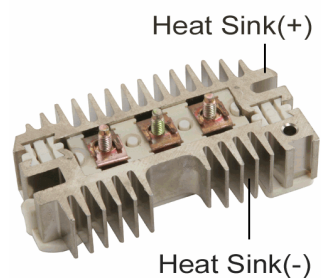

Replaces

DELCO :
 233195

RD-31

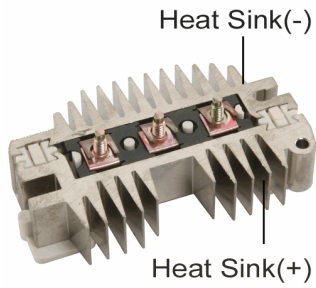

- *6-25 Amps Diodes
- *15SI 70-85 Amps Alternators
- *Negative Ground Version
- *(RD-14 is Positive Ground Version.)

Replaces

DELCO :

1975313 D3919

Unit no.

DELCO

1100184	1100190	1100192	1101077	1101096	1101438
1101446					

RD-31H

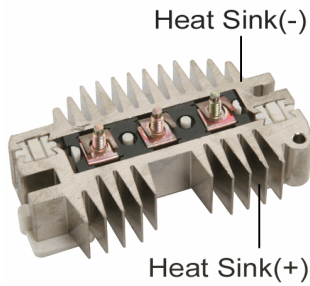

- *6-35 Amps Diodes
- *15SI 70-85 Amps Alternators
- *Negative Ground Version
- *(RD-14H is Positive Ground Version.)
- *Economy Version: RD-31HA

Replaces

DELCO :

1975313 D3919

Unit no.

DELCO

1100184	1100190	1100192	1101077	1101096	1101438
1101446					

RD-33

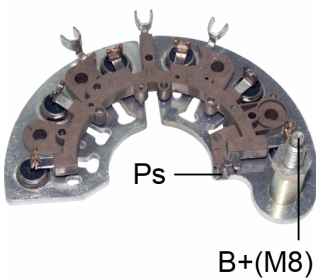

- *6-50A Avalanche Diodes
- *M8 Battery Post

Replaces

DELCO :

19055072

Unit no.

DELCO

10333165	10442783	10333166	10442782
----------	----------	----------	----------

RD-33HD

- *6-70A Avalanche Diodes
- *M8 Battery Post

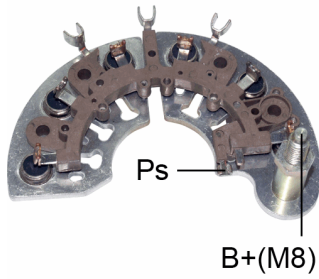

Unit no. [Redacted]
 DELCO
 10346705

RD-35

- *35SI Series
- *6-70A Avalanche Diodes

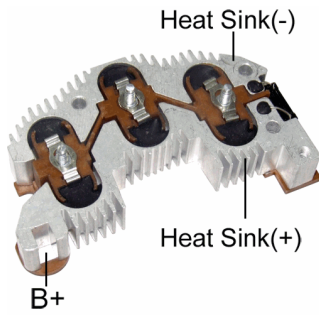

Replaces [Redacted]
 DELCO :
 10511353

RD-35A

- *23SI, 33SI, 34SI Series
- *For 24V System
- *6-70A(38-43V) Avalanche Diodes

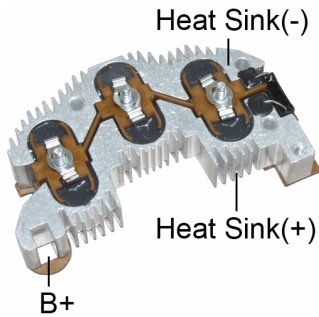

Replaces [Redacted]
 DELCO :
 10501635 10512366

Unit no. [Redacted]
 DELCO
 19011004 19011015 19011019

RD-36

*6-70A Avalanche Diodes
*36SI Series

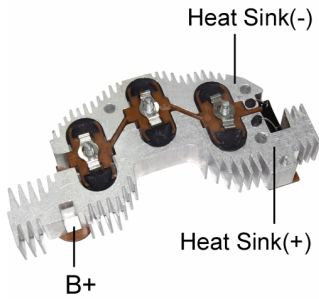

Replaces

DELCO :
10512371

RD-37

*6-35A Avalanche Diodes
*M8 Battery Post

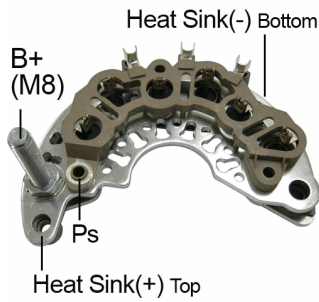

Unit no.

GM
96540542 96838439

Used On

CHEVROLET		
Aveo	1.6L	2004-2007
SUZUKI		
Swift	1.6L	2004-2005

RD-38

*6-50A Avalanche Diodes(32-40V)

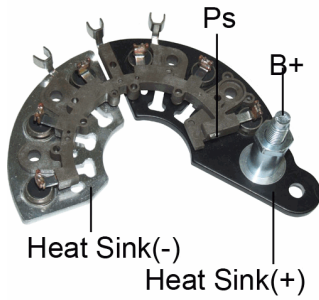

Replaces

DELCO :
10510456

Unit no.

DELCO
8600016 8600017 8600154

RD-38A

*6-50A Avalanche Diodes(24~32V)

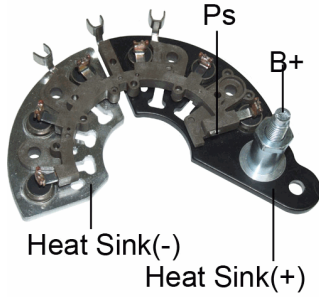

Replaces

DELCO :
10502870

Unit no.

DELCO
19202900 19202901 19202902 19202903

RD-39H

*6-35A Avalanche Diodes
*M8 Battery Post

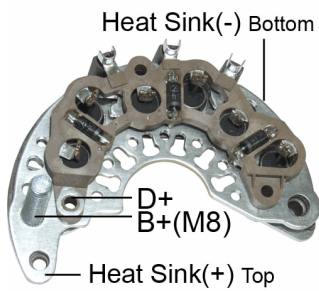

Unit no.

DELCO
1861166 96408588
SUZUKI
31400-85Z00 31400-85Z01

Used On

SUZUKI

Forenza Base	4Cyl 2.0L GAS	2006-
Forenza EX	4Cyl 2.0L GAS	2004-2005
Forenza LX	4Cyl 2.0L GAS	2004-2005
Forenza Premium	4Cyl 2.0L GAS	2006-
Forenza S	4Cyl 2.0L GAS	2004-2005

RD-40H

*M6 Battery Post
*3-70A Avalanche Diodes
*Same as RD-40HA but w/o S.R.E frame
*Regitar No.: RD-40HS

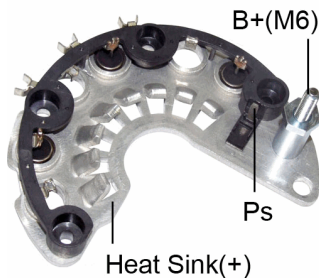

Replaces

DELCO :
10503581 10510904

Unit no.

DELCO
10392759 15200109 15200268 15263858

RD-40HA

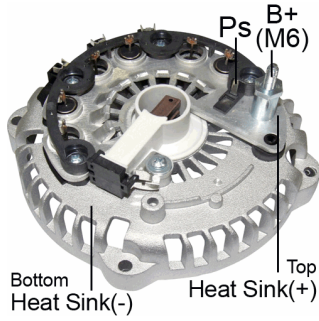

- *150mm OD
- *6-70A Avalanche Diodes
- *M6 Battery Post
- *Negative & Positive Assembly
- *Same as RD-40H but w/S.R.E. frame
- *Regitar No.: RD-40H

Replaces

DELCO :

10503581 10510904

Unit no.

DELCO

10392759 15200109 15200110 15200268 15263858 18000002

RD-41

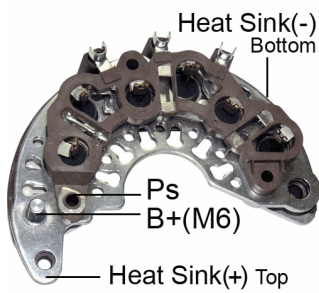

- *6-50A Avalanche Diodes
- *M6 Battery Post

Unit no.

DELCO

96408588

SUZUKI

31400-85Z00 31400-85Z01

RD-95A

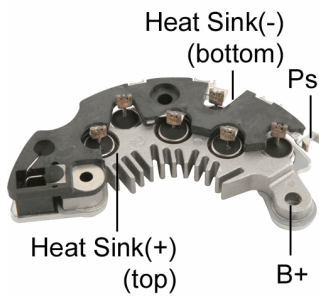

- *6-60A Avalanche Diodes
- *For CS121,CS130 Series Alternators

Replaces

DELCO :

1989658 D3991

Unit no.

DELCO

1101227	1101266	1101267	1101271	1101465	1101467
1101478	1101480	1101565	1101583	1101599	1101605
1101608	1101612	1101816	1102601	1102617	1102644
1105667	1105725	3211068	321338	321344	321348
321349	321350	321351	321352	321353	321365
321424	321425	321430	321435	321436	321455
321457	321469	321496	321523	CS121	CS130

RD-95HD

*6-70A Avalanche Diodes
 *For CS121,CS130 Series Alternators

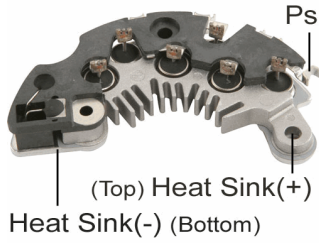

RD-95HV

*6-60A Avalanche Diode Chips
 *For CS121,CS130 Series Alternators

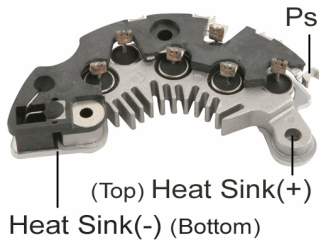

Replaces

DELCO :
 1989658 D3991

Unit no.

DELCO					
1101227	1101266	1101267	1101271	1101465	1101467
1101468	1101480	1101583			

RD-96

*6-50A Avalanche Diodes

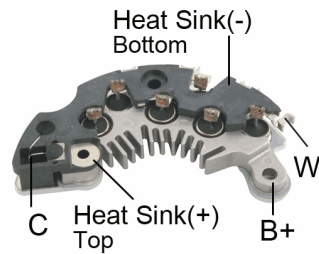

Replaces

DELCO :
 1989658 D3991 10456401 10457236 10457690 10470730
 10472597

Unit no.

DELCO					
1101227	1101266	1101267	1101271	1101465	1101467
1101468	1101480	1101583			

RD-97A

- *6-60A Avalanche Diodes
- *M8 x 36.5mm Battery Post w/14mm Thread
- *For CS130D Series

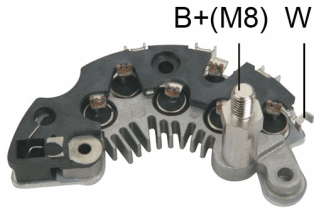

Replaces

DELCO :

10475758 CS130D

Unit no.

DELCO

10463443	10479981	10479984	10480017	10480043	10480052
10480071	10480072	10480119	3211008	3211023	3211025
3211026	3211027	3211031	3211048	3211051	CS130DALTERNATOI

RD-97B

- *6-60A Avalanche Diodes
- *M8 x 32.5mm Battery Post w/11mm Thread

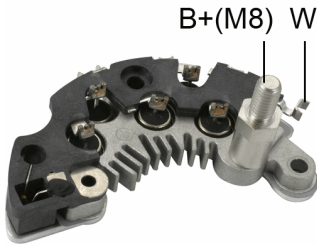

RD-97D

- *6-50A Avalanche Diodes
- *M6 x 30.8mm Battery Post

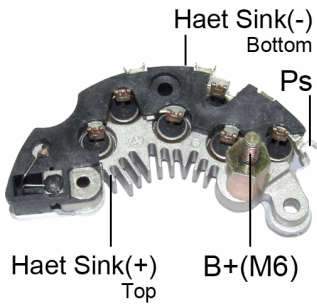

Replaces

DELCO :

10491097 10492837 10492838

Unit no.

DELCO

10479214 10480190

RD-97HD

*6-70A Avalanche Diodes
 *For CS130D Alternators

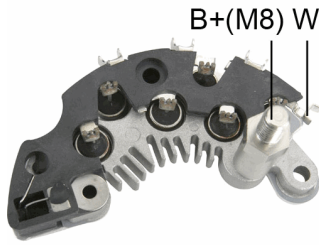

RD-97HV

*6-60A Avalanche Diode Chips
 *For CS130D Alternators

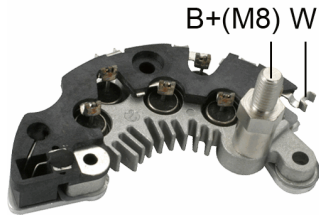

Replaces

DELCO :
 10475758

Unit no.

DELCO

10463443	3211008	3211023	3211025	3211026	3211027
3211031	3211048	3211051			

RD-98A

*6-60A Avalanche Diodes
 *Same as RD-97A but w/o Battery Post



RD-98HD

*6-70A Avalanche Diodes
 *Same as RD-97HD but w/o Battery Post



RD-98HV

*6-60A Avalanche Diode Chips
 *Same as RD-97HV but w/o Battery Post



RD-99

*M8 Battery Post
 *6-50A Avalanche Diodes
 *For CS121,CS130 Series

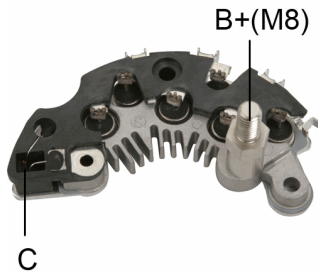

Replaces

DELCO :
 10475758 10491097 10492838

Unit no.

DELCO					
10463443	3122026	3211008	3211023	3211025	3211027
3211031	3211048	3211051			

RN-01

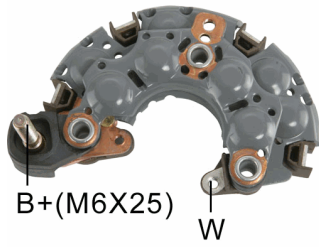

- *103mm OD
- *M6 Battery Post
- *With Mounting Hole for Ground Strap
- *8-50 Amp Diodes

Replaces

DENSO :

025180-3640	025180-4660	025180-4840	021580-3680	021580-4120
-------------	-------------	-------------	-------------	-------------

Unit no.

DENSO

0121000-3000	0121000-3100	0121000-3300	0121000-3310	0121000-3330	0121000-3360
0121000-3370	0121000-3380	0121000-3390	0121000-3400	0121000-3410	0121000-3430
0121000-3440	0121000-3450	0121000-3480	100211-8230	100211-8320	100211-8370
100211-8530	100211-8590	100211-8810	100211-8820	100211-8870	101211-5220
101211-5460	101211-5550				

RN-01P

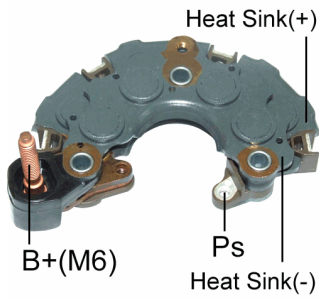

- *103mm OD
- *M6 Battery Post
- *8-35A Avalanche Press-fit Diodes

Unit no.

DENSO

102211-2230	102211-2231	102211-2232	102211-2233
-------------	-------------	-------------	-------------

RN-01PL

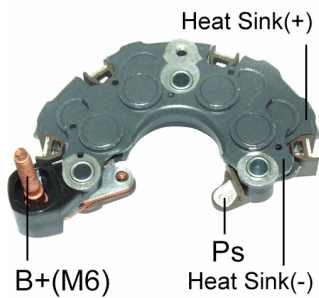

- *103mm OD
- *M6 Battery Post
- *8-35A Avalanche Press-fit Diodes
- *Aluminum Heat Sinks

Unit no.

DENSO

102211-2230	102211-2231	102211-2232	102211-2233
-------------	-------------	-------------	-------------

RN-02

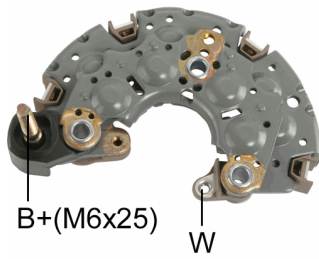

- *113mm OD
- *M6 Battery Post
- *With Mounting Hole for Ground Strap
- *8-50 Amp Diodes

Replaces

DENSO :
021580-4820

Unit no.

CHRYSLER

5233599 5233608 5233660 5234651

DENSO

121000-4000 121000-4010 121000-4030 121000-4040 121000-4050 121000-4060
121000-4070 121000-4080 121000-4090 121000-4130

RN-03

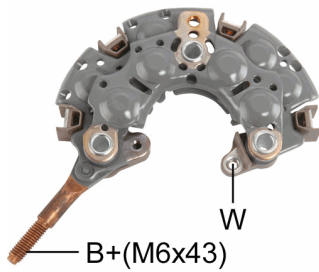

- *103mm OD
- *M6 Battery Post
- *With Mounting Hole for Ground Strap
- *8-50 Amp Diodes

Replaces

DENSO :
021580-3830 021580-4080 021580-4480 021580-4630

Unit no.

DENSO

100211-5110 100211-5150 100211-5270 100211-5620 100211-8020 100211-8030
100211-8050 100211-8070 100211-8150 100211-8300 100211-8380 100211-8390
100211-8540 100211-8550 100211-8560 100211-8570 100211-8740 100211-8750
100211-8770 100211-8860 100211-8911 100211-9330

GM

94847129

TOYOTA

27060-16230 27060-42030

RN-03PL

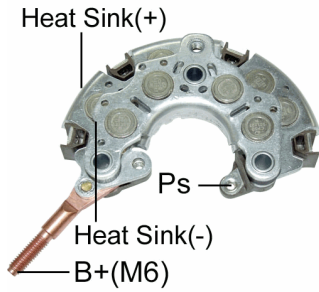

- *103mm OD
- *M6 Battery Post
- *With Mounting Hole for Ground Strap
- *8-50 Amp Press-fit Diodes
- *Aluminum Heat Sinks

Replaces

DENSO :

021580-3830	021580-4080	021580-4480	021580-4630	012580-4510	012580-4760
021580-3660	021580-4030	021580-5160	021580-5810		

HONDA :

31127-PT0-003

TOYOTA :

27357-16310	27357-55080	27357-62040	27357-74050	27357-74160	
-------------	-------------	-------------	-------------	-------------	--

Unit no.

DENSO

100211-5110	100211-5150	100211-5270	100211-5620	100211-8020	100211-8030
100211-8050	100211-8070	100211-8150	100211-8300	100211-8380	100211-8390
100211-8540	100211-8550	100211-8560	100211-8570	100211-8740	100211-8750
100211-8770	100211-8860	100211-8911	100211-9330		

GM

94847129

TOYOTA

27060-16230	27060-42030				
-------------	-------------	--	--	--	--

RN-04

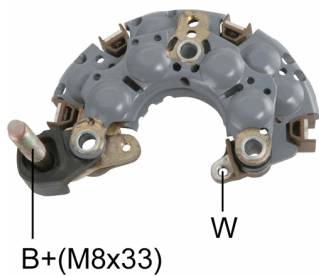

- *103mm OD
- *M8 Battery Post
- *With Mounting Hole for Ground Strap
- *8-50 Amp Diodes

Replaces

DENSO :

021580-4850

Unit no.

DENSO

100211-8620	100211-8630				
-------------	-------------	--	--	--	--

RN-05

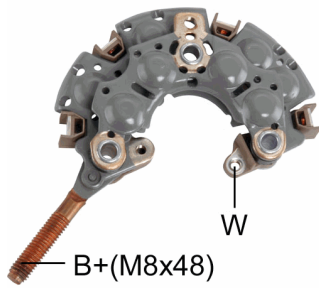

- *103mm OD
- *M8 Battery Post
- *With Mounting Hole for Ground Strap
- *8-50 Amp Diodes

Unit no.
 DENSO
 100211-2400 100211-5450

RN-08

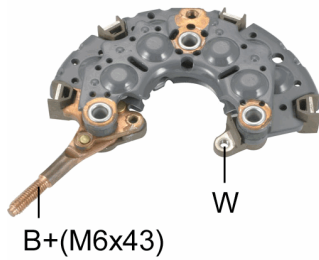

- *113mm OD
- *M6 Battery Post
- *8-50 Amp Diodes
- *Similar to RN-11
- *With Mounting Hole for Ground Strap

Unit no.
 DENSO
 121000-4230 121000-4400

RN-10

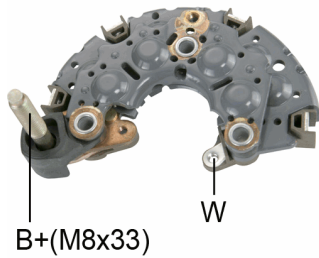

- *113mm OD
- *M8 Battery Post
- *With Mounting Hole for Ground Strap
- *8-50 Amp Diodes

Replaces

BOSCH :
 190053020 192053015 192053020 1197311308 1197311312 1197311327

DENSO :
 021580-4250 021580-4590

HONDA :
 31127-PY3-0030

Unit no.
 DENSO
 100211-6160 100211-6170

HONDA
 31100-PY3-003

RN-11

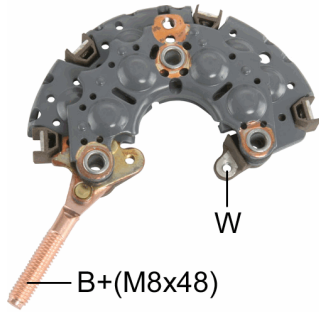

- *113mm OD
- *M8 Battery Post
- *With Mounting Hole for Ground Strap
- *8-50 Amp Diodes

Replaces

DENSO :

021580-3750	021580-3990	021580-4040	021580-4100	021580-4110	021580-4430
021580-4610	021580-4690	021580-5040			

RN-12

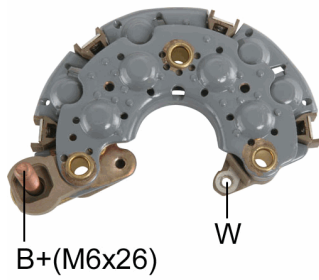

- *100mm OD
- *M6 Battery Post
- *8-50 Amp Diodes

Replaces

DENSO :

021580-2511	021580-2512	021580-2510	021580-2521	021580-2522	021580-5060
-------------	-------------	-------------	-------------	-------------	-------------

ISUZU :

8-94125884-0

TOYOTA :

27357-70081

Unit no.

DENSO

0121000-2500	100211-1070	100211-7780	100211-7910	100211-7950	100211-7951
100211-7952	100211-7990	100211-9890	101211-0160		

ISUZU

8-97027-568-0

RN-13

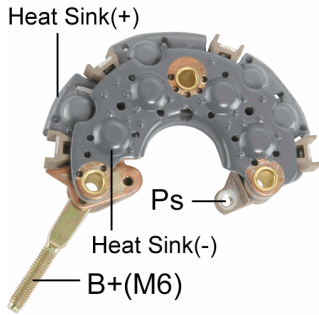

- *100mm OD
- *M6 Battery Post
- *8-50 Amp Diodes

Replaces

DENSO :

021580-2160 021580-2230

TOYOTA :

27060-72010 27357-63020

Unit no.

DENSO

100211-100	100211-1000	100211-1001	100211-1010	100211-1020	100211-1030
100211-104	100211-1040	100211-1041	100211-105	100211-1050	100211-1060
100211-108	100211-1080	100211-1081	100211-1090	100211-1091	100211-1170
100211-118	100211-1180	100211-1440	100211-200	100211-2000	100211-2001
100211-201	100211-2010	100211-2011	100211-202	100211-2020	100211-2021
100211-2030	100211-205	100211-2050	100211-206	100211-2060	100211-2061
100211-207	100211-2070	100211-210	100211-2100	100211-2102	100211-2140
100211-215	100211-2150	100211-217	100211-2170	100211-221	100211-2210
100211-2250	100211-250	100211-2500	100211-255	100211-2550	100211-3030
100211-3040	100211-3060	100211-3070	100211-3090	100211-3150	100211-3170
100211-3180	100211-3190	100211-3210	100211-3240	100211-3260	100211-3300
100211-3310	100211-3320	100211-3350	100211-3390	100211-3400	100211-3410
100211-3430	100211-3520	100211-3630	100211-3680	100211-7000	100211-7040
100211-7050	100211-7060	100211-7070	100211-7100	100211-7140	100211-7180
100211-7330	100211-7440	100211-7450	100211-7460	100211-7500	100211-7570
100211-7800	100211-7810	100211-7820	100211-7970	100211-8910	100211-9710
100211-9730	100211-9770	100211-9780	100211-9840	101211-0070	101211-0120
101211-0130	101211-0190	101211-0250	101211-0340	101211-0590	

HONDA

31100-PD2-024	31100-PD6-014	31100-PH1-014	31100-PH3-0243	31100-PH5-0242	31100-PH7-004
31100-PH7-0040	31100-PH7-0240	31100-PJ0-0633	31100-PK1-004	31100-PK1-0147	31100-PK2-004
31100-PP8-0040	31100-PR3-0030	31100-PR5-0030	31100-PR6-0030		

ISUZU

8-94131-357-2 8-94408-674-0

TOYOTA

27060-16010	27060-16012	27060-16080	27060-16122	27060-43060	27060-43111
27060-63020	27060-63080	27060-63082	27060-63100	27060-63102	27060-72010
27060-72050	27060-72060	27060-72061	27060-72070	27060-72071	27060-72100
27060-72101	27060-74010	27060-78001	27060-78300		

RN-13PL

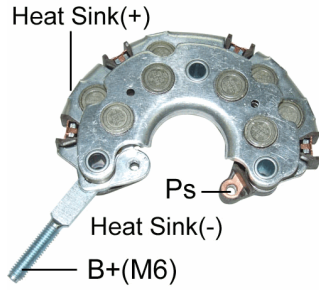

- *100mm OD
- *M6 Battery Post
- *8-50 Amp Press-fit Diodes
- *Aluminum Heat Sinks

Replaces

DENSO :	
021580-2160	021580-2230
TOYOTA :	
27060-72010	27357-63020

Unit no.

DENSO

100211-100	100211-1000	100211-1001	100211-1010	100211-1020	100211-1030
100211-104	100211-1040	100211-1041	100211-105	100211-1050	100211-1060
100211-108	100211-1080	100211-1081	100211-1090	100211-1091	100211-1170
100211-118	100211-1180	100211-1440	100211-200	100211-2000	100211-2001
100211-201	100211-2010	100211-2011	100211-202	100211-2020	100211-2021
100211-2030	100211-205	100211-2050	100211-206	100211-2060	100211-2061
100211-207	100211-2070	100211-210	100211-2100	100211-2102	100211-2140
100211-215	100211-2150	100211-217	100211-2170	100211-221	100211-2210
100211-2250	100211-250	100211-2500	100211-255	100211-2550	100211-3030
100211-3040	100211-3060	100211-3070	100211-3090	100211-3150	100211-3170
100211-3180	100211-3190	100211-3210	100211-3240	100211-3260	100211-3300
100211-3310	100211-3320	100211-3350	100211-3390	100211-3400	100211-3410
100211-3430	100211-3520	100211-3630	100211-3680	100211-7000	100211-7040
100211-7050	100211-7060	100211-7070	100211-7100	100211-7140	100211-7180
100211-7330	100211-7440	100211-7450	100211-7460	100211-7500	100211-7570
100211-7800	100211-7810	100211-7820	100211-7970	100211-8910	100211-9710
100211-9730	100211-9770	100211-9780	100211-9840	101211-0070	101211-0120
101211-0130	101211-0190	101211-0250	101211-0340	101211-0590	

HONDA

31100-PD2-024	31100-PD6-014	31100-PH1-014	31100-PH3-0243	31100-PH5-0242	31100-PH7-004
31100-PH7-0040	31100-PH7-0240	31100-PJ0-0633	31100-PK1-004	31100-PK1-0147	31100-PK2-004
31100-PP8-0040	31100-PR3-0030	31100-PR5-0030	31100-PR6-0030		

ISUZU

8-94131-357-2	8-94408-674-0
---------------	---------------

TOYOTA

27060-16010	27060-16012	27060-16080	27060-16122	27060-43060	27060-43111
27060-63020	27060-63080	27060-63082	27060-63100	27060-63102	27060-72010
27060-72050	27060-72060	27060-72061	27060-72070	27060-72071	27060-72100
27060-72101	27060-74010	27060-78001	27060-78300		

RN-14

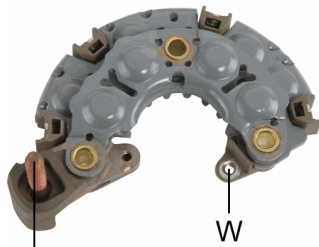

- *100mm OD
- *M6 Battery Post
- *With Mounting Hole for Ground Strap
- *8-50 Amp Diodes

B+(M6x26)

Replaces

DENSO :

021580-4120 021580-4490 021580-3680 021580-3640

TOYOTA :

27357-74120 27357-74290

Unit no.

CHRYSLER

5233418 5233449 5233672

DENSO

0121000-2430 0121000-2680 0121000-3000 0121000-3300 0121000-3310 0121000-3370
 0121000-3380 0121000-3390 0121000-3400 0121000-3450

RN-15

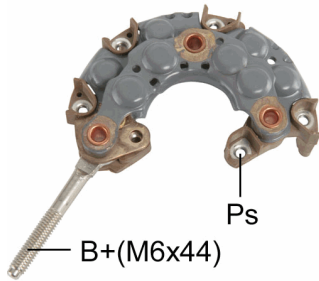

- *90mm OD
- *M6 Battery Post
- *With Mounting Hole for Ground Strap
- *8-50 Amp Diodes

B+(M6x44)

Replaces

DENSO :

021580-3340 021580-4310 021580-4340 021580-3130

TOYOTA :

27375-72150 27357-72120

Unit no.

DAIHATSU

27060-87706

DENSO

100211-1430 100211-1550 100211-1560 100211-1570 100211-1580 100211-1610
 100211-3500 100211-4070 100211-4130 100211-4150 100211-4170 100211-4260
 100211-4350 100211-4460 100211-4490 100211-6600 100211-6720 100211-6870
 100211-6880 100211-6990 101211-2020 101211-2130

ISUZU

8-94449-781-1

RN-15PL

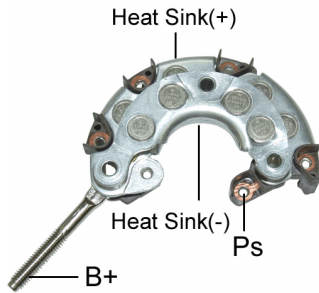

- *90mm OD
- *M6 Battery Post
- *With Mounting Hole for Ground Strap
- *8-50 Amp Press-fit Diodes
- *Aluminum Heat Sinks

Replaces

DENSO :
021580-3130
TOYOTA :
27375-72150

Unit no.

DAIHATSU
27060-87706
DENSO
100211-1430
100211-3500
100211-4350
100211-6880
ISUZU
8-94449-781-1

RN-16

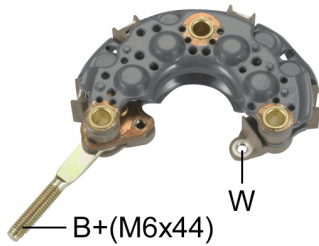

- *90mm OD
- *M6 Battery Post
- *With Mounting Hole for Ground Strap
- *8-50 Amp diodes

Replaces

DENSO :
021580-2250 021580-2260
TOYOTA :
27375-6340

Unit no.

DENSO
100211-1200 100211-1210 100211-1230 100211-1260 100211-1270 100211-1310
100211-1320 100211-1340 100211-1350 100211-1360 100211-1370 100211-1380
100211-2170 100211-2210 100211-2250 100211-2280 100211-2330 100211-2370
100211-2380 100211-3220 100211-3500 100211-3510 100211-3530 100211-3540
100211-3550 100211-3590 100211-3610 100211-3660 100211-3690 100211-3770
100211-3820 100211-3890 100211-3960 100211-3970
HONDA
31100-PEO-003
ISUZU
8-94413-621-0
TOYOTA
27060-10011 27060-10060 27060-10061 27060-10090 27060-11010 27060-11050
27060-15040 27060-16091 27060-55020 27060-63041 27060-64020 27060-64021

RN-17

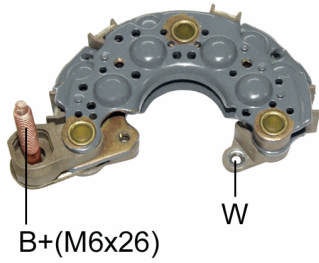

- *90mm OD
- *M6 Battery Post
- *8-50 Amp Diodes

Replaces

DENSO :		
021580-2340	021580-2341	021580-2342
ISUZU :		
16231-64851		

Unit no.

DENSO		
100211-1200	100211-1330	100211-3720
ISUZU		
8-97137-345-2		

RN-18

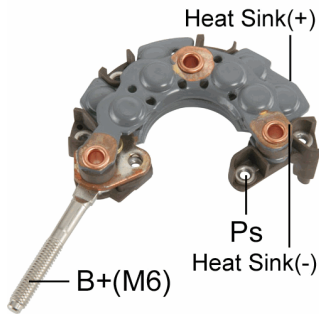

- *83mm OD
- *M6 Battery Post
- *With Mounting Hole for Ground Strap
- *8-35 Amp Diodes

Replaces

DENSO :		
021580-3110		

Unit no.

DENSO		
100211-454	100211-4540	

RN-19

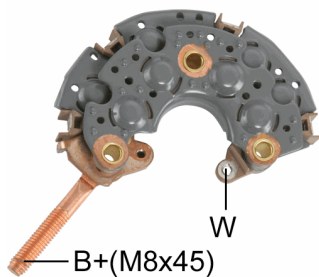

- *107mm OD
- *M8 Battery Post
- *With Mounting Hole for Ground Strap
- *8-50 Amp Diodes

Replaces

DENSO :		
100211-1830	100211-2840	
Unit no.		
DENSO		
100211-183	100211-1830	100211-2840
TOYOTA		
27060-43100	27060-43130	

RN-20

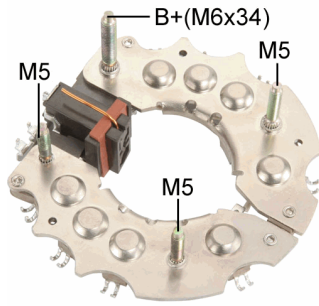

- *114mm OD
- *M6 Battery Post
- *8-35 Amp Diodes

Replaces

DENSO :

021600-1491 021600-1531 021600-1561

TOYOTA :

27362-15070 27362-43020

Unit no.

DENSO

100211-0530 100211-0550 100211-0560 100211-0590 100211-0630 100211-0650

100211-0660 100211-0670

TOYOTA

27060-15020 27060-28050 27060-43020 27060-43021 27060-43030 27060-43040

RN-22

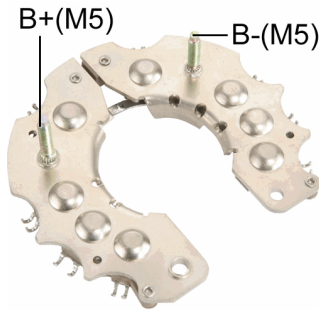

- *114mm OD
- *M5 Battery Post
- *8-35 Amp Diodes
- *Same as RN-20 but without Brush Holder

Replaces

DENSO :

021600-1491 021600-1531 021600-1561

TOYOTA :

27362-15070 27362-43020

Unit no.

DENSO

100211-0530 100211-0550 100211-0560 100211-0590 100211-0630 100211-0650

100211-0660 100211-0670

TOYOTA

27060-15020 27060-28050 27060-43020 27060-43021 27060-43030 27060-43040

RN-24

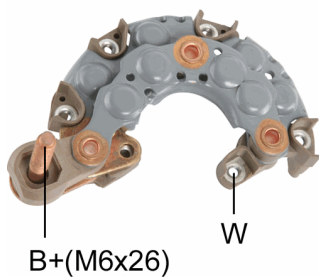

- *90mm OD
- *M6 Battery Post
- *With Mounting Hole for Ground Strap
- *8-50 Amp Diodes

Unit no.

DENSO

100211-2460

RN-26

- *83mm OD
- *M6 Battery Post
- *8-50 Amp Diodes

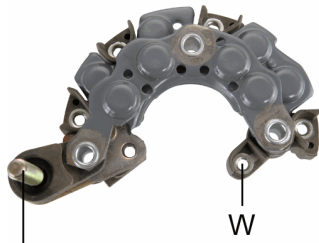

B+(M6)

Replaces

DENSO :

021580-3890 021580-3450

Unit no.

DENSO

100211-1670	100211-4640	100211-4650	100211-4520	100211-4528	100211-4610
100211-4740	100211-4770	101211-1360			

RN-29

- *117mm OD
- *M8 Battery Post
- *12-50 Amp Diodes

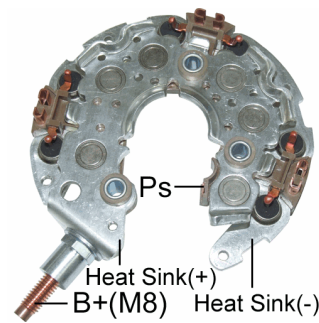

Unit no.

DENSO

421000-001 421000-002 421000-004 421000-006

RN-30

- *117mm OD
- *M8 Battery Post
- *12-50 Amp Diodes

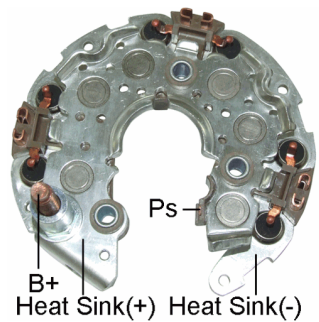

Unit no.

DENSO

4210000120

RN-31

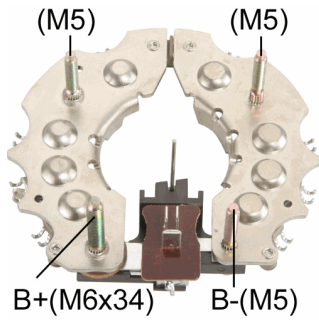

*113mm OD
*8-35 Amp Diodes

Replaces

DENSO :
021600-1840
TOYOTA :
27362-63011

Unit no.

DENSO
021000-8270 021000-8310 021000-8311 021000-8340

RN-32

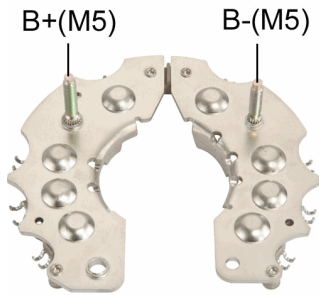

*113mm OD
*6-35 Amp Diodes

Replaces

DENSO :
021600-0750 021600-1420 021600-1610

Unit no.

DENSO
0121000-1010 0121000-1011 0121000-1012 021000-6610 021000-6611 021000-6630
021000-6640 021000-6710 021000-8230 021000-8231

RN-33

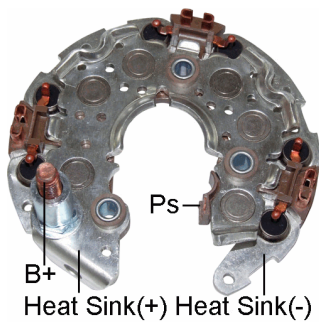

*117mm OD
*M8 Battery Pos
*12-50A Avalanche Diodes

Unit no.

DENSO
10421-3090

RN-34

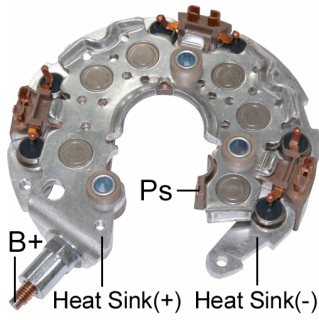

- *117mm OD
- *M6 Battery Post
- *12-50A Avalanche Diodes

Replaces

DENSO :
7060

Unit no.

DENSO				
104210-347	104210-420	104210-2360	104210-5370	10421-0338
HONDA				
31100-RZP-G01	CSF37			
TOYOTA				
27060-0P020	27060-31020	27060-0V030	27060-OP240	27060-0F040

Used On

TOYOTA				
TACOMA 4 Cyl.				2007-2009

RN-36

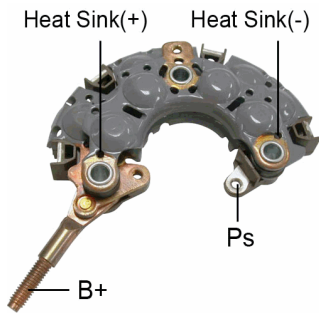

- *107mm OD
- *M6 Battery Post
- *6-35A Avalanche Diodes

Replaces

DENSO :			
021580-06510	021580-5510	021580-5560	
TOYOTA :			
27357-22050	27357-22200		

Unit no.

DENSO					
102211-1920	102211-1990	102211-2380	102211-2480	104210-8181	104210-8590
TOYOTA					
27060-75490	27060-0H010	27060-21150	27060-22040	27060-22080	27060-28170

Used On

TOYOTA			
Yaris	1.5L		2006-2009
TACOMA 2.7 4 Cyl.			2007-2010

RN-37

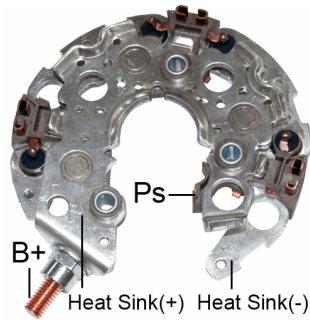

- *117mm OD
- *M8 Battery Post
- *7-50A Avalanche Diodes

Unit no.

DENSO			
104210-3512	104210-3513	104210-3511	
FORD			
3M5T-10300PD	3M5T-10300PC		

Used On

FORD

Fiesta V	(JH_JD_) 1.6 TDCi 66kW	2004-
C-MAX	1.6 TDCi 80kW	2003-2007
Focus II	(DA_) 1.6 TDCi 80kW	2004-
Focus II	(DA_) 2.0 TDCi 100kW	2004-
Fusion	(JU_) 1.6 TDCi 66kW	2004-

RN-38

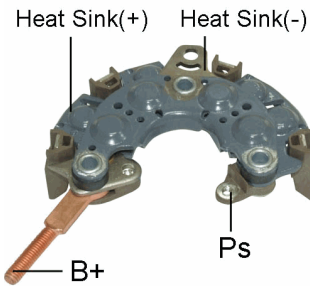

- *100mm OD
- *M6 Battery Post
- *With Mounting Hole for Ground Strap
- *8-50 Amp Diodes

Replaces

DENSO :
021580-5300

Unit no.

DENSO					
102211-5013	102211-5022	102211-504	102211-5151	102211-5270	102211-5961
ISUZU					
29012-37800	29012-37801	89710-97800	89710-97801		
SUZUKI					
31400-77E22	31400-77E23				
TOYOTA					
27060-62190					

Used On

SUZUKI

Escudo	2.4	1996-1998
Sidekick	1.8L	1996-1998

TOYOTA

4-Runner	3.4L	1996-1998
4-Runner	2.7L	1996-1998
Tundra Pickup	3.4L	2000-2001

RN-39

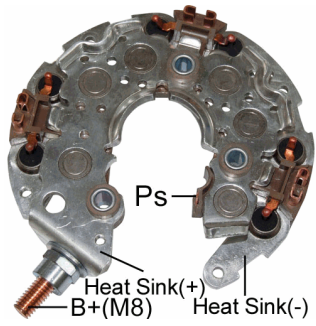

- *117mm OD
- *M8 Battery Post
- *12-50A (19-24V) Avalanche Diodes

Unit no.

DENSO		
104210-3521	104210-3522	104210-3523
FORD		
3M5T-10300YB	3M5T-10300YC	3M5T-10300YD

RN-40

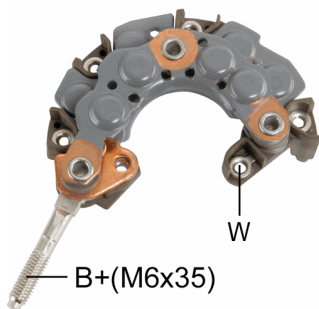

- *83mm OD
- *M6 Battery Post
- *8-50 Amp Diodes

Replaces

DENSO :	
021580-3080	101211-1250

Unit no.

CHRYSLER	
4609999AB	56041324
DENSO	
100211-1680	121000-4250
TOYOTA	
27060-0F020	

RN-41

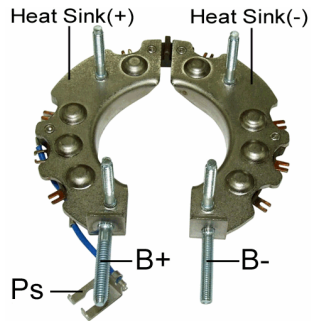

- *114mm OD
- *M6 Battery Post
- *8-35 Amp Diodes

Replaces

DENSO :

021590-1890 021590-1900 021590-1910 021590-1950

Unit no.

DENSO

100211-1573 100211-2211 100211-2280 100211-2302 100211-2570 121000-0820

Used On

HONDA

Civic 1984-1987

ISUZU

TFR 1993-1993

TOYOTA

Celica 1.6GT 1986-1989

Land Cruiser 2.4D

RN-44

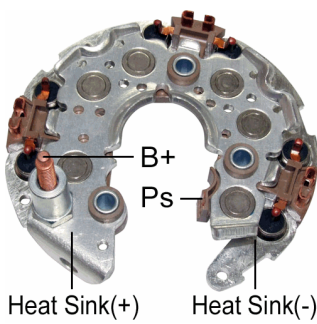

- *117mm OD
- *M6 Battery Post
- *12-50A Avalanche Diodes

Replaces

DENSO :

021580-5920

Used On

GM

Buick 3.8L 2004-2005

Cadillac 4.6L 2001-2002

Cadillac CTS 3.2L 2003-2004

RN-45

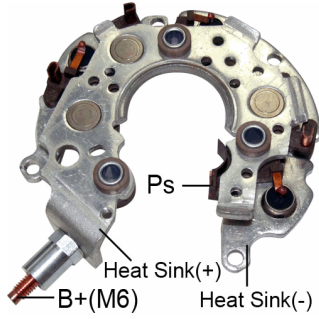

- *105mm OD
- *M6 Battery Post
- *6-35A Avalanche Diodes

Unit no.

DENSO
104210-9050
TOYOTA
27060-0H090

RN-45H

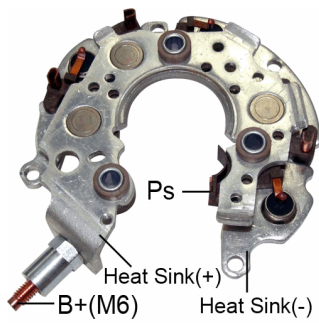

- *105mm OD
- *M6 Battery Post
- *6-50A Avalanche Diodes

Unit no.

DENSO
104210-900
TOYOTA
27060-0C020

Used On

TOYOTA
Fortuna

RN-46

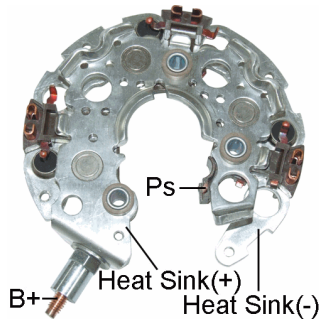

- *117mm OD
- *M6 Battery Post
- *6-50A Avalanche Diodes

Replaces

DENSO :
021580-6610

Unit no.

DENSO					
104210-388	104210-389	104210-533	104210-4471	104210-2341	
TOYOTA					
27060-0P140	27060-0P141	27060-0H100	27060-28270	27060-28350	27060-0V010

Used On

TOYOTA

Camary	2.4L	2006-
Highlander	2.4L	2007-
Solara	2.4L	2008-

RN-47

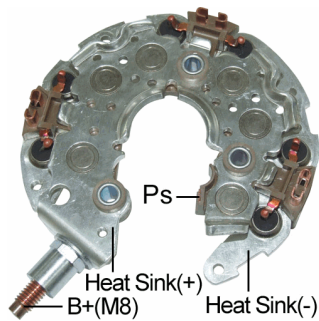

- *117mm OD
- *M8 Battery Post
- *12-50A Avalanche Diodes

Unit no.

DENSO			
104210-400	104210-448	104210-1240	
HONDA			
31100-RV0-A01	31100-RCB-Y02	31100-RGL-A01	31100-RGW-A01
TOYOTA			
27060-50340			

RN-48

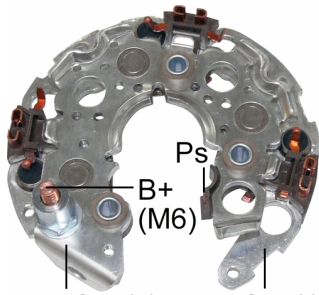

- *117mm OD
- *M6 Battery Post
- *6-50A Avalanche Diodes

Replaces

DENSO :
021580-6490

Unit no.

DENSO				
104210-3290	104210-3291	104210-3292	104210-3293	
HONDA				
31100-RAA-A01	31100-RAA-A03	31100-RAA-A04	31100-RAA-A05	

Used On

HONDA

Accord 2.4L	2003-2005
Element 2.4L	2003-2006

RN-49

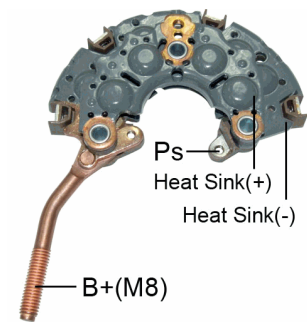

- *113mm OD
- *With Mounting Hole for Ground Strap
- *8-50 Amp Diodes

Replaces

DENSO :
021580-4890

Unit no.

DENSO				
100211-6300	101211-7090	101211-7091	101211-7800	102211-0730
MAZDA				
KJ01-18-300	KJ01-18-300A			

RN-50L

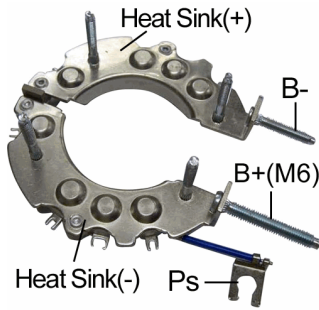

- *114mm OD
- *M6 Battery Post
- *8-35A Avalanche Diodes
- *Aluminum Heat Sinks

Replaces

DENSO :

021590-2050 021590-1990

Unit no.

DENSO

100213-0750 100213-0760 100213-0770 100213-0790 100213-0950 100213-0960

RN-51

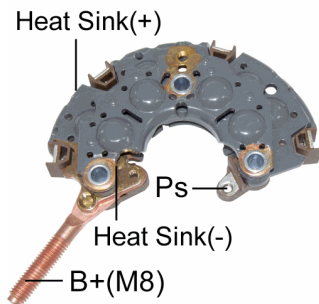

- *113mm OD
- *M8 Battery Post
- *8-50A Avalanche Diodes

Replaces

DENSO :

021580-4780

Unit no.

DENSO

100211-6420

RN-53

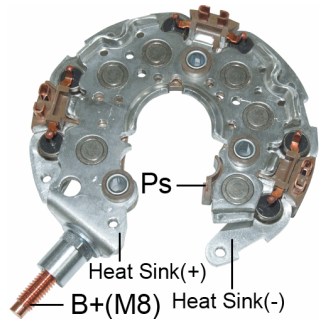

- *117mm OD
- *M8 Battery Post
- *12-50A Avalanche Diodes

Unit no.

DENSO

421000-0410 421000-0470 421000-0530 421000-0540 421000-0541 421000-0542
 421000-0560 421000-0700

RN-54

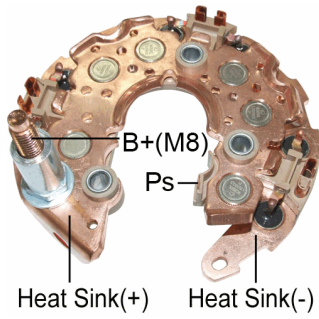

- *117mm OD
- *M8 Battery Post
- *12-50A Avalanche Diodes

Unit no.

DENSO					
104210-2160	104210-4220	104210-4370			
GM					
15139480	25755840	25862643			

RN-55

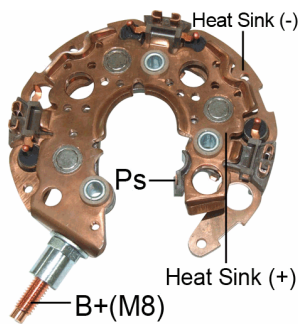

- *117mm OD
- *M8 Battery Post
- *7-50 Amp Diodes

Unit no.

CHRYSLER					
04606755AC	04868431AF	04868431AG	4606755AC	4868431AF	4868431AG
56028697AA					
DENSO					
421000-0210	421000-0222	421000-0223	421000-0225	421000-0230	

RN-56

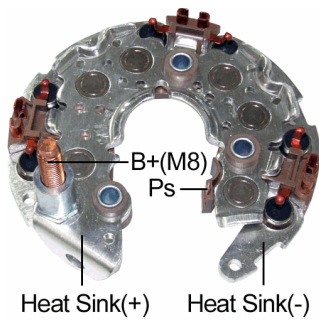

- *117mm OD
- *M8 Battery Post
- *12-50A Avalanche Diodes

Unit no.

CHRYSLER					
56029915AB	56044380AH				
DENSO					
421000-0150	421000-0260	421000-0261	421000-0343	421000-0343	421000-0344
421000-0344	421000-0360	421000-0552			

RN-57

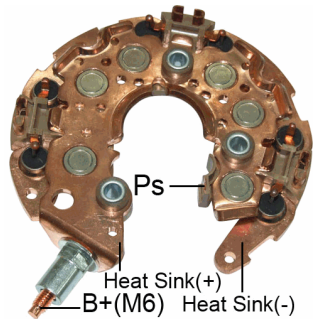

- *117mm OD
- *M6 Battery Post
- *12-50A Avalanche Diodes

Replaces

DENSO :
021580-5941

Unit no.

DENSO
104210-4090 104210-4091
FORD
5F9T-10300BB 5F9Z-10346BA

RN-59

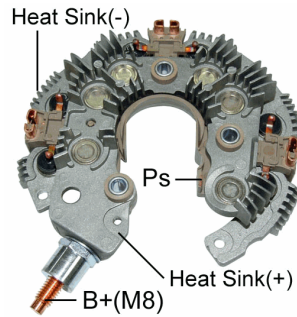

- *134mm OD
- *M8 Battery Post
- *12-50A Avalanche Diodes

Replaces

DENSO :
785

Unit no.

DENSO
104210-6140
TOYOTA
27060-38050

Used On

LEXUS

LX570 5.7L 2008-2011

TOYOTA

Land Cruiser 5.7L 2008-2010

Sequoia 4.6L 2010-2012

Sequoia 5.7L 2008-2012

RN-60

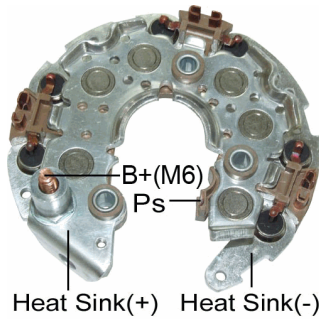

- *117mm OD
- *M6 Battery Post
- *12-50A Avalanche Diodes

Unit no.
 DENSO
 104210-589
 HONDA
 31100-R40-A01

RN-63

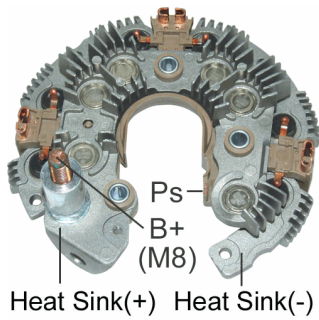

- *134mm OD
- *M8 Battery Post
- *12-50A Avalanche Diodes

Unit no.
 DENSO
 104210-6101 104210-600 104210-611 104210-6010 104210-6110
 FORD
 7C3T-10300EE
 GM
 15817893 15868747
 SUZUKI
 31400-78J10

RN-64

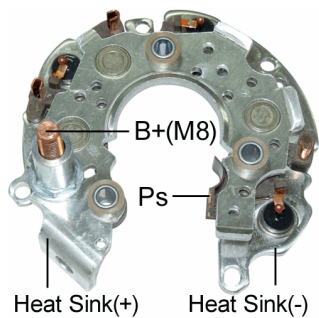

- *105mm OD
- *M8 Battery Post
- *6-50A Avalanche Diodes

Unit no.
 DENSO
 104210-9031 104210-2341
 TOYOTA
 8973697161

RN-66

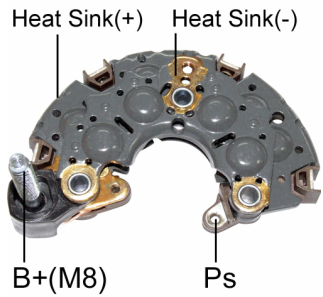

- *113mm OD
- *M8 Battery Post
- *With Mounting Hole for Ground Strap
- *8-50 A Avalanche Diodes

Unit no. [Redacted]
 HYUNDAI
 37300-3C170
 POONG SUNG
 02131-9330

Used On
HYUNDAI
 Entourage 3.8L 2007-2008
KIA
 Sedona 3.8L 2007-2008

RN-67

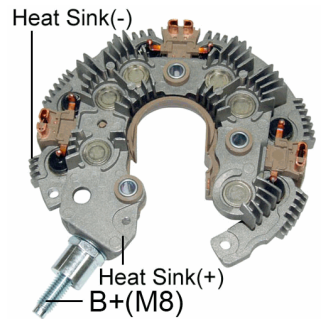

- *134mm OD
- *M8 Battery Post
- *12-50A Avalanche Diodes

Unit no. [Redacted]
 DENSO
 104210-6340 104210-6180 104210-6182 104210-6181 104210-6270 104210-6670
 104210-6220

Used On
FORD
 F150 3.7L 2011-

RN-69

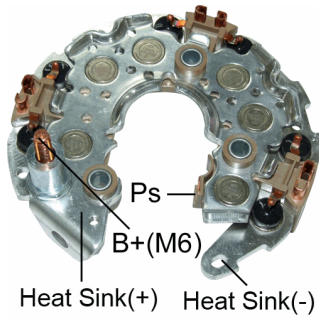

- *117mm OD
- *M6 Battery Post
- *12-50A Avalanche Diodes

Unit no.

DENSO				
104210-1530				
HONDA				
31100-RTA-003	31100-RTA-013	31100-RTA-023	31100-RWC-A01	31100-RX0-A01RM

Used On

HONDA	
Accord 2.4L	2003-2005
Accord 2000 16V	2002-2008
Accord 2400 16V	2002-2008
Civic 2000	2007-2012
Element 2.4L	2003-2006

RN-70

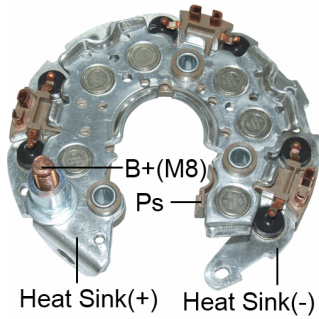

- *117mm OD
- *M8 Battery Post
- *12-50A Avalanche Diodes

Unit no.

DENSO	
104210-3970	104210-3971
HONDA	
31100-RFE-003	

Used On

HONDA	
Odyssey	2005-2008

RI-07H

*6-35 Amp Diodes
*110mm OD



Replaces

BOSCH :

9-121-337-337

FEMSA :

28466-6

LUCAS :

UBB600

TOSHIBA :

7G2 7H4

Unit no.

BOSCH

9-120-330-227	9-120-330-292	9-120-330-502	9-120-330-505	9-120-330-506	9-120-330-522
---------------	---------------	---------------	---------------	---------------	---------------

9-120-330-533	9-120-335-217				
---------------	---------------	--	--	--	--

FEMSA

ALB12117	ALB30X92	ALB4077	ALE242	ALE2422	ALE2423
----------	----------	---------	--------	---------	---------

ALE245	ALE246				
--------	--------	--	--	--	--

RI-08H

*6-35 Amp Diodes
*110mm OD

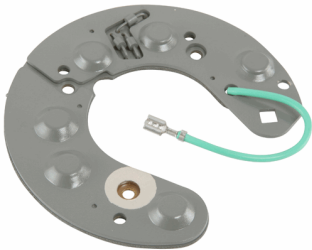

Replaces

BOSCH :

9-121-337-324

FEMSA :

25945-9

TOSHIBA :

7M2

Unit no.

BOSCH

9-120-331-802	9-120-331-805	9-120-331-806	9-120-331-814	9-120-331-819	9-120-331-820
---------------	---------------	---------------	---------------	---------------	---------------

9-120-331-855					
---------------	--	--	--	--	--

FEMSA

ALS12N14	ALS12N55	ALS24N20	ALS24N5	ALS24NX19	ALS24NX2
----------	----------	----------	---------	-----------	----------

ALS24NX6					
----------	--	--	--	--	--

FIAT

4376376	4474933				
---------	---------	--	--	--	--

MAGNETI MARELLI

63303213	63303780				
----------	----------	--	--	--	--

RI-09H

*6-35 Amp Diodes
*110mm OD

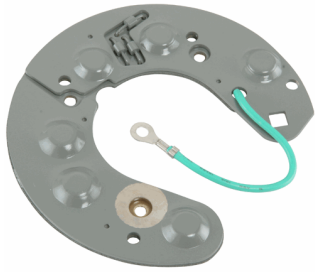

Replaces

BOSCH :
9-121-337-323

FEMSA :
25945-8

Unit no.

BOSCH
9-120-331-847
FEMSA
ALS12N47

RF-01

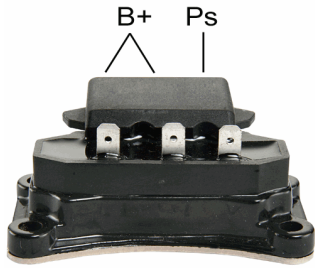

- *6-25 Amp Diodes
- *FORD 2G series 75-80 AMP IR/EF Alternators
- *40-65A Internally Regulated Alternators

Replaces

FORD :
 E43Z-10304A E43Z-10335A
MOTORCRAFT :
 GY-1351

RF-02

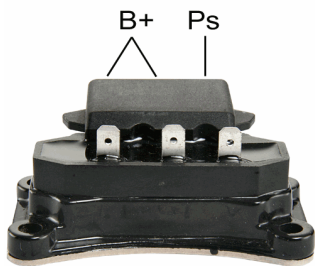

- *6-35 Amp Diodes
- *Copper Heat Sink
- *FORD 2G series 75-80 AMP IR/EF Alternators

Replaces

FORD :
 E6DZ-10304 E6DZ-10304A
MOTORCRAFT :
 GY-1360

RF-02B

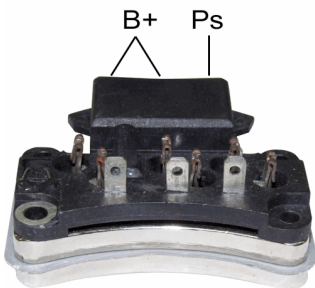

- *6-35 Amp Diodes
- *Welded Construction
- *Hi-Temp PA6T Plastic Leadframe (300 degree C)
- *Positive stator connections
- *Heavy Duty Tinned Copper Stator Terminals
- *Double Heatsinks Exceeds OE
- *Passed Testing At 300 degree C

RF-03

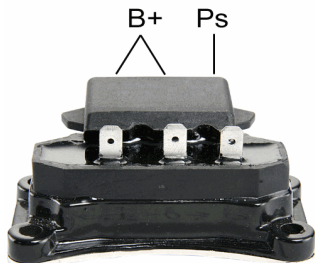

- *6-50 Amp Diodes
- *Copper Heat Sink

RF-03B

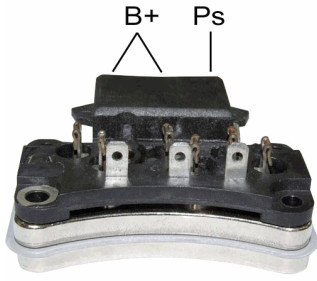

- *6-50 Amp Diodes
- *Welded Construction
- *Hi-Temp PA6T Plastic Leadframe (300 degree C)
- *Positive stator connections
- *Heavy Duty Tinned Copper Stator Terminals
- *Double Heatsinks Exceeds OE
- *Passed Testing At 300 degree C

RF-043

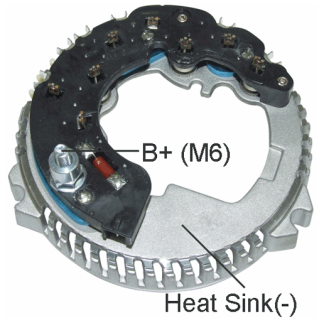

- *8-35 Amp Diodes
- *133mm OD
- *W/Drop Down Leads

Replaces

FORD :
F5AZ-10304BA

Unit no.

FORD

98AB-10300EB	98AZ-10346EA	98BB-10300CC	A8ZU-10300AC	F8AU-10300AC	F8RZ-10346CC
GL456	XS8Z-10346BB	XS8Z-10346BBRM	XS91-10300BB	XS91-10300BC	

RF-043HV

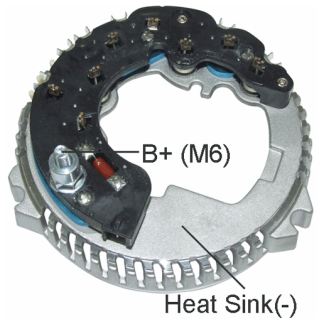

- *8-70 Amp Diodes
- *133mm OD
- *W/Drop Down Leads

RF-04HV

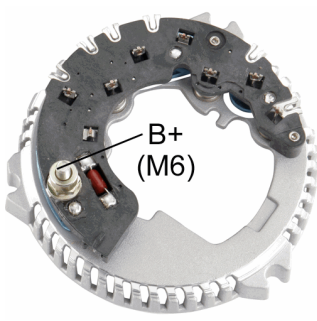

- *8-70 Amp Diodes
- *133mm Outside Diameter

RF-053

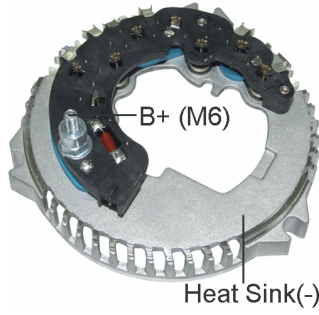

- *8-50 Amp Diodes
- *147mm OD
- *W/Drop Down Leads

Replaces

FORD :

F5AZ-10304AA FODU-10A366DAIP

Unit no.

FORD

94BB-10300AE	96BB-10300AB	97BB-10300AC	F0DF-10300BA	F0DU-10300BC	F0DZ-10346B
F0DZ-10346C	F0DZ-10346E	F1DU-10300AD	F1DZ-10346A	F1DZ-10346B	F2TU-10300AF
F2UU-10300BE	F2UU-10300DC	F2UU-10300FA	F37U-10300AA	F3AU-10300AC	F3AU-10300BA
F3AU-10300CA	F3DU-10300BB	F4DU-10300AA	F4DU-10300BA	F4DU-10300CA	F4DU-10300DA
F4PU-10300AA	F4PU-10346BA	F4PU-10346DA	F4PZ-10346BRM	F4PZ-10346D	F4PZ-10346DRM
F4SU-10300AB	F4ZU-10300DA	F58U-10300AB	F5AU-10300AA	F5PU-10346CA	F5PU-10346PA
F5PZ-10346PA	F5PZ-10346PARM	F5RU-10300BA	F5UU-10300AA	F5UU-10300BA	F65U-10300BB
F6AU-10300AA	F6PU-10300AA	F6PZ-10346B	F75U-10300CA	F8ZU-10300BA	XU2U-10346AA
XU2Z-10346AA					

RF-053HV

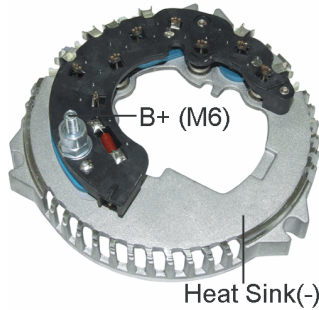

- *8-70A Avalanche Diodes
- *147mm OD
- *W/Drop Down Leads

Replaces

FORD :

F5AZ-10304AA

Unit no.

FORD

F0DF-10300BA	F0DU-10300BC	F0DZ-10346B	F0DZ-10346C	F0DZ-10346E	F2UU-10300BE
--------------	--------------	-------------	-------------	-------------	--------------

RF-063

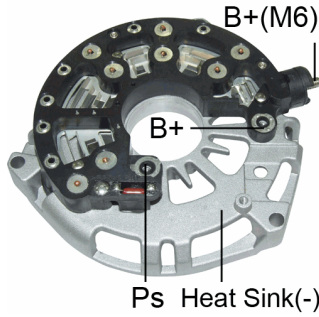

- *133mm OD
- *8-50 Amp Diodes
- *W/Drop Down Leads

Replaces

FORD :

F5OZ-10300FA F6DU-10300BB F6LU-10300CA F6OU-10300AA F6ZU-10300BB 139668

MOTORCRAFT :

GL-331

Unit no.

FORD

A006-T41491	F50U-10300FC	F5DU-10300DB	F5OU-10300FA	F5OU-10300GS	F60U-10300AA
F60U-10300AB	F60Y-10346AA	F68U-10300AD	F68U-10300AF	F68U-10300AS	F6DU-10300BB
F6DU-10300BD	F6DU-10300DB	F6DU-10300DC	F6DU-10300DD	F6DZ-10346B	F6DZ-10346BRM
F6DZ-10346D	F6DZ-10346DRM	F6LU-10300CA	F6LU-10300CB	F6LU-10300CC	F6LU-10300CD
F6LU-10346A	F6LY-10346A	F6OU-10300AA	F6ZU-10300BB	F6ZU-10300BC	F6ZU-10300BE
F6ZU-10300BF	F6ZU-10300BG	F6ZZ-10346B	F6ZZ-10346BRM	F77U-10300AB	F77U-10300AC
F77Z-10346AB	F77Z-10346ABRM	F78U-10300AA	F78Z-10346AA	F78Z-10346AARM	F80U-10300CA
F80U-10300CB	F80Z-10346CA	XF2Z-10346AA	XL2U-10300AA	XL2Z-10346AA	XL2Z-10346AARM
XL3U-10300AA	XL3U-10300AB	XL3Z-10346AA	XW7U-10300AA	XW7U-10300AD	XW7Z-10346AA
XW7Z-10346AARM					

RF-063HV

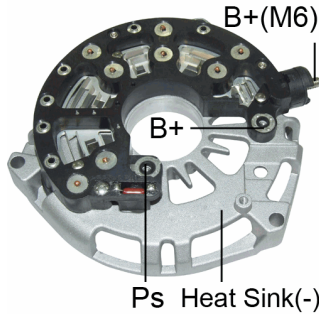

- *133mm OD
- *8-70A Avalanche Diodes
- *W/Drop Down Leads

Unit no.

FORD

A006-T41491	F50U-10300FC	F5DU-10300DB	F5OU-10300FA	F5OU-10300GS	F60U-10300AA
F60U-10300AB	F60Y-10346AA	F68U-10300AD	F68U-10300AF	F68U-10300AS	F6DU-10300BB
F6DU-10300BD	F6DU-10300DB	F6DU-10300DC	F6DU-10300DD	F6DZ-10346B	F6DZ-10346BRM
F6DZ-10346D	F6DZ-10346DRM	F6LU-10300CA	F6LU-10300CB	F6LU-10300CC	F6LU-10300CD
F6LU-10346A	F6LY-10346A	F6OU-10300AA	F6ZU-10300BB	F6ZU-10300BC	F6ZU-10300BE
F6ZU-10300BF	F6ZU-10300BG	F6ZZ-10346B	F6ZZ-10346BRM	F77U-10300AB	F77U-10300AC
F77Z-10346AB	F77Z-10346ABRM	F78U-10300AA	F78Z-10346AA	F78Z-10346AARM	F80U-10300CA
F80U-10300CB	F80Z-10346CA	XF2Z-10346AA	XL2U-10300AA	XL2Z-10346AA	XL2Z-10346AARM
XL3U-10300AA	XL3U-10300AB	XL3Z-10346AA	XW7U-10300AA	XW7U-10300AD	XW7Z-10346AA
XW7Z-10346AARM					

RF-07H

*6-35 Amp Diodes



Replaces

FORD :
 D6AZ10304A D9VY10304A GY1306A

Unit no.

FORD
 GY1306A

RF-07HV

*6-50 Amp Diodes



Replaces

MOTORCRAFT :
 GY-1306A

RF-08H

*6-35 Amp Diodes

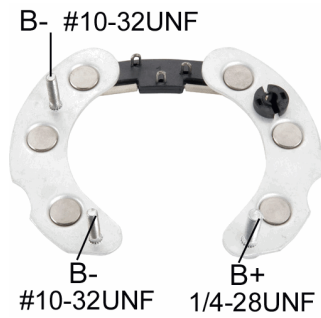

Replaces

DELCO :
 A3900

FORD :
 D6AZ-10304A D9VY-10304A

MOTORCRAFT :
 GY-1306A GY-1327

RF-08HV

*6-70 Amp Diodes

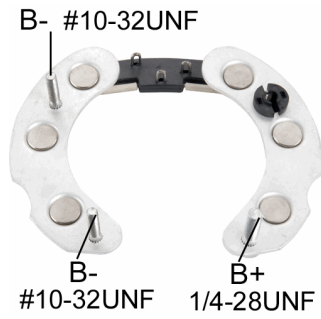

Replaces

DELCO :
A3900

FORD :
D6AZ-10304A

MOTORCRAFT :
GY-1306A

Unit no.

DELCO

A3900

FORD

D64Z-10304A

D9VY-10304A

MOTORCRAFT

GY-1306A

GY-1327

RF-09H

*6-35 Amp Diodes



Replaces

FORD :
D2OZ-10304A

MOTORCRAFT :
GY-1026

Unit no.

FORD

GL215

RF-09HV

*6-70 Amp Diodes



Replaces

FORD :

D2OZ-10304A F0TZ-10304A GY-1026-A

MOTORCRAFT :

GY-1026A

Unit no.

FORD

D9AF-10300CA E3TF-10300AB E4LF-10300CA E6DF-10300CA E9TF-10300AA F0TU-10300AA

RF-103

*136mm OD
*8-50 Amp Diodes
*W/Drop Down Leads

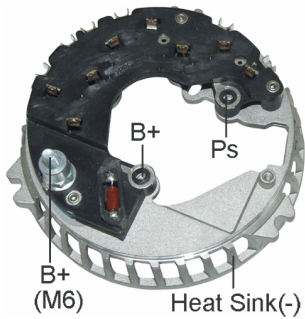

Replaces

FORD :

F8WU10A366AIP F8WU10A366AA F8WU10A336AA1P

Unit no.

FORD

1S41-10300BB	4C3Z-10346AA	98AB-10300FC	98AZ-10346FA	F81U-10300BA	F81U-10300BC
F81U-10300CC	F81U-10300CD	F81U-10300DB	F81U-10300DC	F81U-10300DD	F81U-10300EB
F81U-10300GA	F81Z-10346BA	F81Z-10346CA	F81Z-10346DA	F81Z-10346EA	F81Z-10346GA
F8WU-10A366AA	XF2U-10300AB	XF2Z-10346AARM	XR3U-10300AA	XR3U-10300AB	XR3U-10300AC
XR3Z-10346AA	XR3Z-10346AARM	ZR3U-10300AB			

RF-103HV

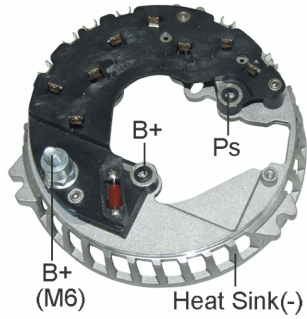

- *136mm OD
- *8-70A Avalanche Diodes
- *W/Drop Down Leads

Replaces

FORD :
F8WU-10A366AAIP

Unit no.

FORD

1S41-10300BB	4C3Z-10346AA	98AB-10300FC	98AZ-10346FA	F81U-10300BA	F81U-10300BC
F81U-10300CC	F81U-10300CD	F81U-10300DB	F81U-10300DC	F81U-10300DD	F81U-10300EB
F81U-10300GA	F81Z-10346BA	F81Z-10346CA	F81Z-10346DA	F81Z-10346EA	F81Z-10346GA
F8WU-10A366AA	XF2U-10300AB	XF2Z-10346AARM	XR3U-10300AA	XR3U-10300AB	XR3U-10300AC
XR3Z-10346AA	XR3Z-10346AARM	ZR3U-10300AB			

RF-113

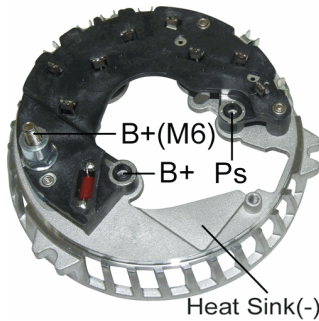

- *136mm OD
- *8-50 Amp Diodes
- *W/Drop Down Leads

Replaces

FORD :
233208

Unit no.

FORD

98AB-10300EB	98AZ-10346EA	98BB-10300CC	A8ZU-10300AC	F8AU-10300AC	F8RZ-10346CC
GL456	XS8Z-10346BB	XS8Z-10346BBRM	XS91-10300BB	XS91-10300BC	

RF-123

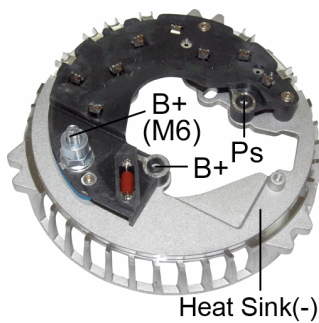

- *149mm OD
- *8-50 Amp Diodes
- *W/Drop Down Leads

Replaces

FORD :
F8AU10A366AA F8AU10A366AAIP

Unit no.

FORD

3W1U-10300BB	3W1Z-10346BARM	F8AU-10300AB	F8AU-10300AD	F8AZ-10346AB	F8AZ-10346ABRM
F8ZU-10300AC	XF2U-10300BC	XF2U-10300BD	XF2Z-10346BA	XF2Z-10346BARM	

RF-123HV

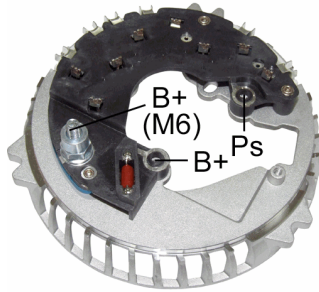

- *149mm OD
- *8-70A Avalanche Diodes
- *W/Drop Down Leads

Replaces

FORD :
F8AU-10A366AAIP

Unit no.

FORD
 3W1U-10300BB 3W1Z-10346BARM F8AU-10300AB F8AU-10300AD F8AZ-10346AB F8AZ-10346ABRM
 F8ZU-10300AC XF2U-10300BC XF2U-10300BD XF2Z-10346BA XF2Z-10346BARM

RF-124

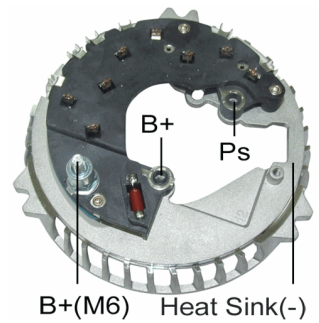

- *149mm OD
- *8-50 Amp Diodes

Unit no.

FORD
 5C3T-10300BA 5C3Z-10346BA 6C3T-10300BA 6C3Z-10346BA

RF-125

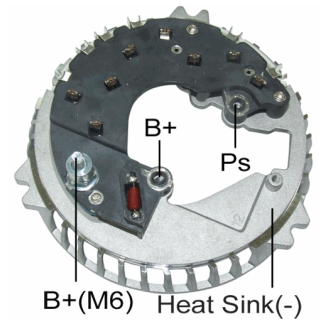

- *149mm OD
- *8-50A Avalanche Diodes

Unit no.

FORD
 3L74-10300AA 3L74-10300BA 3L74-10300BB 3L74-10346AA 3L7Z-10346AA 3L7Z-10346BA
 6F2Z-10346BA

RF-133

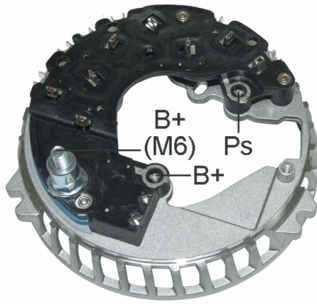

- **Replace RF-13
- *131mm OD
- *M6 Battery Post
- *6-50 Amp Diodes
- *W/Drop Down Leads

Unit no.

FORD

1L8U-10300CE	1L8Z-10346CB	GL453	GL463	GL466	XS8Z-10346AA
XS91-10300AE	XW4U-10300AA	XW4U-10300AB	XW4U-10300BA	XW4U-10300BB	XW4Z-10346AA
XW4Z-10346BA	YF1U-10300FA	YF1U-10300FB	YF1Z-10346FA		

RF-143

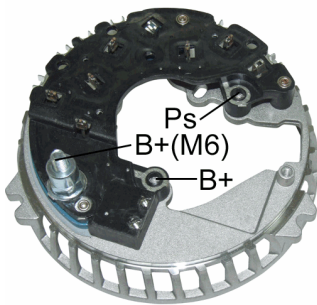

- **Replace RF-14
- *131mm OD
- *M6 Battery Post
- *6-50 Amp Diodes
- *W/Drop Down Leads

Unit no.

FORD

1L8Z-10346CB

RF-153

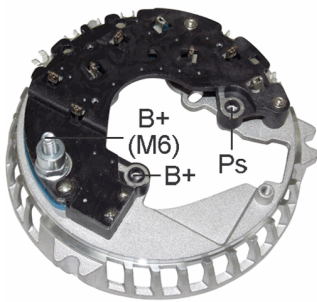

- *131mm OD
- *M6 Battery Post
- *6-50 Amp Diodes
- *W/Drop Down Leads

Unit no.

FORD

1L8Z-10346AB

RF-16HD

*6-70 Amp Diodes

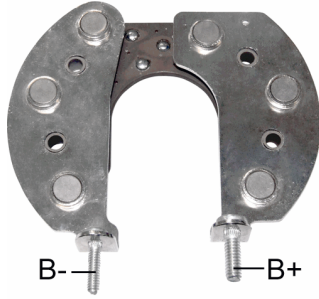

Replaces

FORD :
 D3VY-10304A E9DZ-10304A F0HZ-10304A
MOTORCRAFT :
 GY-1302 GY-1302B GY-1345A GY-1346

RF-16HV

*6-50 Amp Diodes

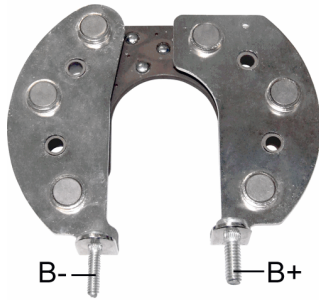

Replaces

FORD :
 D3VY-10304A E9DZ-10304A F0HZ-10304A
MOTORCRAFT :
 GY-1302 GY-1302B GY-1345A GY-1346

RF-18HV

*8-50A Avalanche Diodes
 *M6 Battery Post

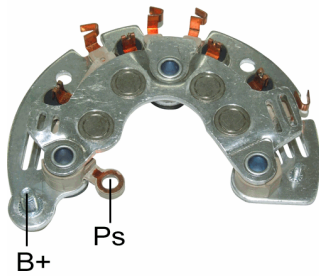

Unit no.

FORD
 1S7T-10300BA 1S7T-10300BB 1S7T-10300BC 1S7T-10300DB 1S7T-10300DC

RF-19H

*M6 Battery Post
*8-50 Amp Diodes

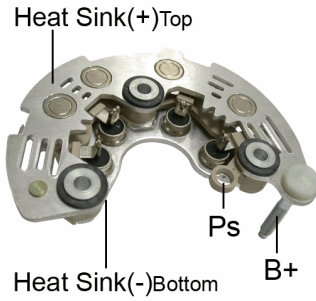

Unit no.

FORD
CX1FA
VALEO
3N2110300BB

RF-22HV

*105mm OD
*M6 Battery Post
*8-50A Avalanche Diodes

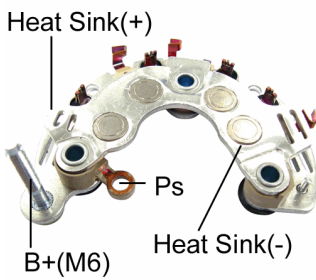

Unit no.

FORD
2S6T-10300FA 2S6T-10300FB
VISTEON
20-150-01001

RF-23W

*6-50 Amp Diodes
*FORD 2G Series 40-80A IR/EF Alternators

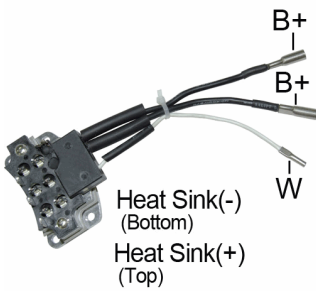

Replaces

FORD :
E43Z-10304A E6DZ-10304A E6DZ10304 GY1351 GY1360

RH-01

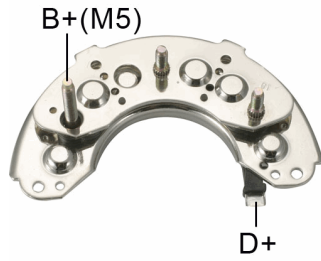

- *118mm OD
- *Aluminum Heat Sink
- *M5 Battery Post w/diode Trio
- *6-35 Amp Diodes

Replaces

HITACHI :

L150-13203 L160-3320

NISSAN :

23230-06500 23230-Q4601

SUBARU :

49534-7101

Unit no.

HITACHI

LR155-15C	LR160-104	LR160-105	LR160-109	LR160-110	LR160-116
LR160-117	LR160-130	LR160-133	LR160-78	LR160-78B	LR160-82
LR160-82B	LR160-84	LR160-84B	LR160-93	LR170-14	LR170-18
LT150-113	LT150-114	LT150-123			

NISSAN

23100-29R00	23100-D0201	23100-D0800	23100-D1700	23100-D3300	23100-H7205
23100-V0101	23100-V0102	23100-V0106	23100-V0107	23100-W5806	23100-W5807

SUBARU

23700-AA00Q	23700-AA020	23700-AA160	42990-7000	42990-7010	42990-7300
42990-7320	42990-7330	42990-7340	42990-7400	42990-7500	42990-7600
42990-7700					

RH-01C

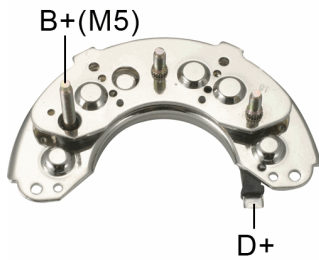

- *118mm OD
- *Copper Heat Sinks
- *M5 Battery Post w/diode Trio
- *6-35 Amp Diodes

Replaces

HITACHI :

L150-13203 L160-3320

NISSAN :

23230-06500 23230-Q4601

SUBARU :

49534-7101

Unit no.

HITACHI

LR155-15C LR160-104 LR160-105 LR160-109 LR160-110 LR160-116

LR160-117 LR160-130 LR160-133 LR160-78 LR160-78B LR160-82

LR160-82B LR160-84 LR160-84B LR160-93 LR170-14 LR170-18

LT150-113 LT150-114 LT150-123

NISSAN

23100-29R00 23100-D0201 23100-D0800 23100-D1700 23100-D3300 23100-H7205

23100-V0101 23100-V0102 23100-V0106 23100-V0107 23100-W5806 23100-W5807

SUBARU

23700-AA00Q 23700-AA020 23700-AA160 42990-7000 42990-7010 42990-7300

42990-7320 42990-7330 42990-7340 42990-7400 42990-7500 42990-7600

42990-7700

RH-02

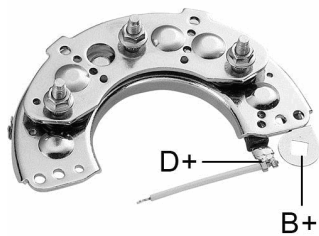

- *111mm OD
- *Aluminum Heat Sink
- *M5 Battery Post w/diode Trio
- *6-35 Amp Diodes

Replaces

HITACHI :

L150-13204

ISUZU :

8-94237-729-0

NISSAN :

23232-W1700

Unit no.

HITACHI

LR150-117C LR150-133B LR150-133E LR150-136E LR150-147C LR150-148C

LR150-155B LR150-157B LR150-158 LR150-165 LR150-201B LR150-202

LR150-203 LR150-205B LR150-206 LR150-211B LR150-212B LR150-79H

LR155-16B

ISUZU

5-81200-316-3 8-94111-836-0 8-94122-220-1 8-94169-952-0 8-94170-993-0 8-94241-630-2

8-94244-298-2 8-94401-793-2 8-94404-636-0 8-94405-044-2 8-94411-907-2 8-94411-908-2

NISSAN

23099-34W01 23099-36W01 23099-36W02 23099-36W04 23100-17S00 23100-G3701

23100-W1802

RH-02C

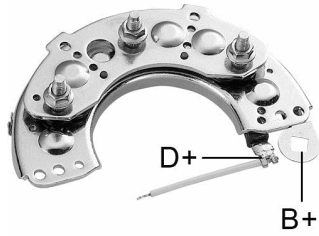

- *111mm OD
- *Copper Heat Sinks
- *M5 Battery Post w/diode Trio
- *6-35 Amp Diodes

Replaces

HITACHI :
L150-13204
ISUZU :
8-94237-729-0
NISSAN :
23232-W1700

Unit no.

HITACHI					
LR150-117C	LR150-133B	LR150-133E	LR150-136E	LR150-147C	LR150-148C
LR150-155B	LR150-157B	LR150-158	LR150-165	LR150-201B	LR150-202
LR150-203	LR150-205B	LR150-206	LR150-211B	LR150-212B	LR150-79H
LR155-16B					
ISUZU					
5-81200-316-3	5-94111-836-0	8-94122-220-1	8-94169-952-0	8-94170-993-0	8-94241-630-2
8-94244-298-2	8-94401-793-2	8-94404-636-0	8-94405-044-2	8-94411-907-2	9-94411-908-2
NISSAN					
23099-34W01	23099-36W01	23099-36W02	23099-36W04	23100-17S00	23100-G3701
23100-W1802					

RH-03

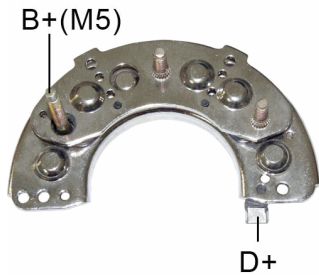

- *111mm OD
- *Aluminum Heat Sink
- *M5 Battery Post w/diode Trio
- *6-35 Amp Diodes

Replaces

HITACHI :
L140-93202 L150-73203 L160-6320 L160-9320 L150-13206
ISUZU :
5-81262-006-0
NISSAN :
23230-W7101

Unit no.

HITACHI					
LR150-101B	LR150-125	LR150-125B	LR150-140	LR150-186C	LR150-98B
LR150-99	LR150-99B	LR225-68B	LR225-80	LR235-58	LR235-62
LR235-69	LR235-70	LR240-21			
ISUZU					
1-81200-262-2					
NISSAN					
23099-S9000	23099-T9004	23099-W5804	23099-Z5560	23099-Z5561	23100-C7101
23100-D0101	23100-H7702	23100-H7703	23100-M6600	23100-M6601	23100-N9502
23100-T9001	23100-W5803	23100-W5805	23100-Z5518		

RH-03C

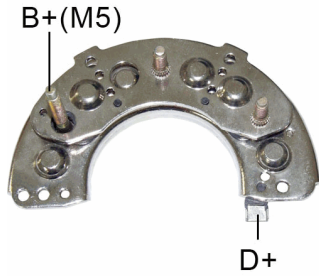

- *111mm OD
- *Copper Heat Sinks
- *M5 Battery Post w/diode Trio
- *6-35 Amp Diodes

Replaces

HITACHI :

L150-13206

ISUZU :

5-81262-006-0

NISSAN :

23230-W7101

Unit no.

HITACHI

LR150-101B	LR150-125	LR150-125B	LR150-140	LR150-186C	LR150-98B
LR150-99	LR150-99B	LR225-68B	LR225-80	LR235-58	LR235-62
LR235-69	LR235-70	LR240-21			

ISUZU

1-81200-262-2

NISSAN

23099-S9000	23099-T9004	23099-W5804	23099-Z5560	23099-Z5561	23100-C7101
23100-D0101	23100-H7702	23100-H7703	23100-M6600	23100-M6601	23100-N9502
23100-T9001	23100-W5803	23100-W5805	23100-Z5518		

RH-04

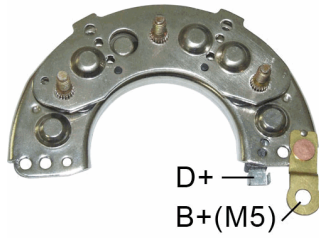

- *111mm OD
- *Aluminum Heat Sink
- *M5 Battery Post w/diode Trio
- *6-35 Amp Diodes

Replaces

HITACHI :

L140-13202	L140-53202	L150-43203	L150-83201	L150-83202	L160-13202
L160-13203	L160-4320	L160-53202	L160-7320	L160-93201	L170-5320
L170G-63201	L225-4320	L225-6320			

ISUZU :

8-94167-411-0

NISSAN :

23232-02N09	23232-16A00	28230-E3200	23232-09W01	23232-10G01	23232-18A00
23232-18G00	23232-V6601				

Unit no.

HITACHI

LR140-130P	LR140-402	LR140-408	LR140-415	LR150-139P	LR150-401C
LR150-402C	LR150-403	LR150-421C	LR150-423	LR150-425B	LR150-431
LR155-16P	LR155-408	LR160-401	LR160-401C	LR225-402	LR225-403
LR225-410	LR225-65P	LR225-67P			

ISUZU

8-94122-488-3 8-94452-739-0

NISSAN

23099-09W00	23099-29W00	23099-C6808	23099-C8600	23099-R8109	23099-R8110
23099-R8111	23099-R8701	23099-R8741	23099-V1708	23100-10G04	23100-16A01
23100-17A01	23100-18A00	23100-18A01	23100-18G02	23100-C8602	23100-C8604

RH-04C

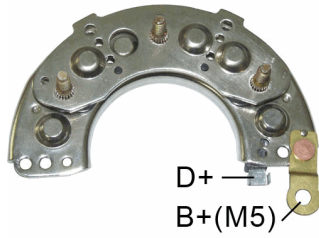

- *111mm OD
- *Copper HEat Sinks
- *M5 Battery Post w/diode Trio
- *6-35 Amp Diodes

Replaces

HITACHI :

L140-13202	L140-53202	L150-83201	L150-83202	L160-4320
------------	------------	------------	------------	-----------

ISUZU :

8-94167-411-0

NISSAN :

23232-09W01	23232-10G01	23232-18A00	23232-18G00	23232-V6601
-------------	-------------	-------------	-------------	-------------

Unit no.

HITACHI

LR140-130P	LR140-402	LR140-408	LR140-415	LR150-139P	LR150-401C
LR150-402C	LR150-403	LR150-421C	LR150-423	LR150-425B	LR150-431
LR155-16P	LR155-408	LR160-401	LR160-401C	LR225-402	LR225-403
LR225-410	LR225-65P	LR225-67P			

ISUZU

8-94122-488-3	8-94452-739-0
---------------	---------------

NISSAN

23099-09W00	23099-29W00	23099-C6808	23099-C8600	23099-R8109	23099-R8110
23099-R8111	23099-R8701	23099-R8741	23099-V1708	23100-10G04	23100-16A01
23100-17A01	23100-18A00	23100-18A01	23100-18G02	23100-C8602	23100-C8604

RH-04N

- *111mm OD
- *Iron Heat Sink
- *M5 Battery Post w/diode Trio
- *6-35 Amp Diodes

Replaces

HITACHI :

L140-13202	L140-53202	L150-43203	L150-83201	L150-83202	L160-13202
L160-13203	L160-4320	L160-53202	L160-7320	L160-93201	L170-5320
L170G-63201	L225-4320	L225-6320			

ISUZU :

8-94167-411-0

NISSAN :

23232-02N09	23232-16A00	28230-E3200	23232-09W01	23232-10G01	23232-18A00
23232-18G00	23232-V6601				

Unit no.

HITACHI

LR140-130P	LR140-402	LR140-408	LR140-415	LR150-139P	LR150-401C
LR150-402C	LR150-403	LR150-421C	LR150-423	LR150-425B	LR150-431
LR155-16P	LR155-408	LR160-401	LR160-401C	LR225-402	LR225-403
LR225-410	LR225-65P	LR225-67P			

ISUZU

8-94122-488-3 8-94452-739-0

NISSAN

23099-09W00	23099-29W00	23099-C6808	23099-C8600	23099-R8109	23099-R8110
23099-R8111	23099-R8701	23099-R8741	23099-V1708	23100-10G04	23100-16A01
23100-17A01	23100-18A00	23100-18A01	23100-18G02	23100-C8602	23100-C8604

RH-05C

- *100mm OD
- *Copper Heat Sinks
- *6-35 Amp Diodes w/diode trio

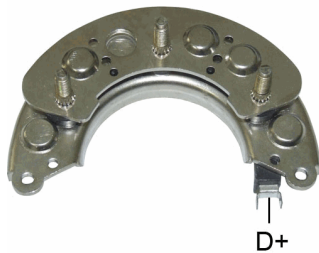

Replaces

HITACHI :

L150-43202

ISUZU :

8-94424-362-0

Unit no.

HITACHI

LR155-504

ISUZU

8-94362-744-0

RH-06C

- *111mm OD
- *Copper Heat Sinks
- *6-35 Amp Diodes



Replaces

HITACHI :
L150-13205

ISUZU :
8-94223-968-0

Unit no.

HITACHI

LR150-155B	LR150-78E	LR155-12C	LT150-112C	LT150-115C	LT150-116C
LT150-154	LT150-196	LT150-77C	LT225-73	LT225-75	LT225-76B

ISUZU

5-81200-294-2	5-81200-295-2	5-81200-301-2	5-81200-302-2	5-81200-348-0	5-81200-351-0
5-81200-351-1	5-94150-397-0	8-94221-450-3	8-94246-251-0		

RH-08C

- *111mm OD
- *Copper Heat Sinks
- *M6 Battery Post w/diode Trio
- *6-35 Amp Diodes

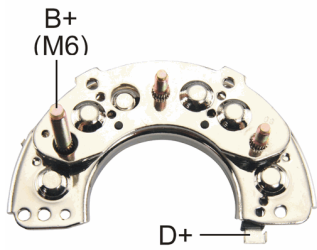

Replaces

HITACHI :
L160-33202 L160-73202

Unit no.

HITACHI

LR150-194B	LR150-197	LR150-197B	LR160-140B	LR160-151
------------	-----------	------------	------------	-----------

NISSAN

23100-80W00

RH-09C

B+(M5)



- *111mm OD
- *Copper HEat Sinks
- *M5 Battery Post
- *6-35 Amp Diodes

Replaces

HITACHI :
L150-13202

NISSAN :
23230-P4505

SUBARU :
49534-7001

Unit no.

HITACHI
LT150-131 LT150-144

RH-102

Heat Sink(-)

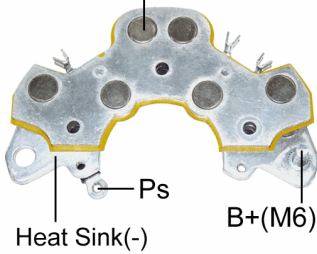

- *119mm OD
- *12-35 Avalanche Diodes
- *M6 Battery Post

Unit no.

HITACHI
LR1130-703 LR1130-703A LR1130-703B LR1130-703BR

NISSAN
23100-EA200 23100-EA20A 23100-EA20AR

Used On

INFINITI		
QX56 8 Cyl. 5.6L		2007-
NISSAN		
Armada 8 Cyl. 5.6L		2007-
Pathfinder 6 Cyl. 4.0L		2005-2007
Titan 8 Cyl. 5.6L		2007-

RH-103

- *114mm OD
- *M6 Battery Post
- *6-50A Avalanche Diodes

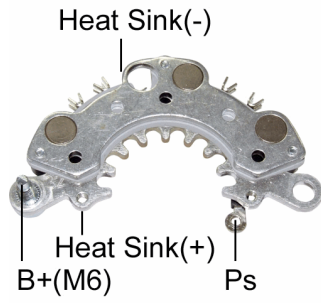

Unit no. [REDACTED]
HITACHI
LR180-769
NISSAN
23100-4Z400

RH-104

- *119mm OD
- *M6 Battery Post
- *8-35A Avalanche Diodes

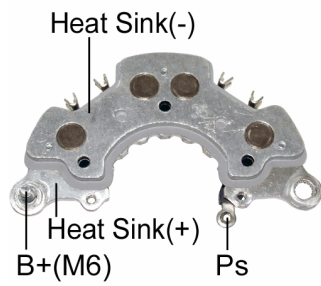

Unit no. [REDACTED]
HITACHI
LR1110-501
SUZUKI
89724-82970

RH-10C

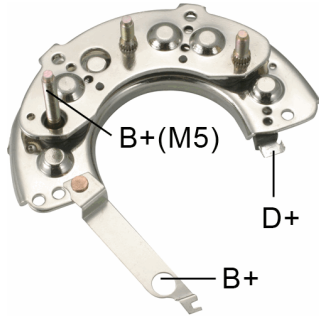

- *111mm OD
- *Copper HEat Sinks
- *Same as RH-03C except with Strap Terminal
- *M5 Battery Post w/diode Trio
- *6-35 Amp Diodes

Replaces

HITACHI :

L150-13206

ISUZU :

5-81262-006-0

NISSAN :

23230-W7101

Unit no.

HITACHI

LR150-101B	LR150-125	LR150-125B	LR150-140	LR150-186C	LR150-98B
LR150-99	LR150-99B	LR225-68B	LR225-80	LR235-58	LR235-62
LR235-69	LR235-70	LR240-21			

ISUZU

1-81200-262-2

NISSAN

23099-S9000	23099-T9004	23099-W5804	23099-Z5560	23099-Z5561	23100-C7101
23100-D0101	23100-H7702	23100-H7703	23100-M6600	23100-M6601	23100-N9502
23100-T9001	23100-W5803	23100-W5805	23100-Z5518		

RH-111

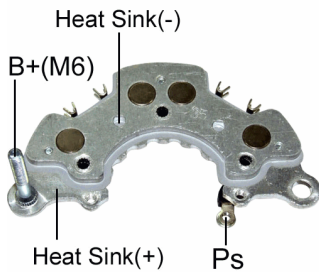

- *119mm OD
- *M6 Battery Post
- *8-50A Avalanche Diodes

Unit no.

HITACHI

LR280-501	LR280-506	LR280-508
-----------	-----------	-----------

ISUZU

8-97248-914-1	8-97332-502-0	8-97351-574-0
---------------	---------------	---------------

RH-113

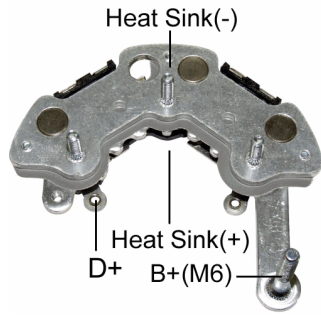

- *119mm OD
- *M6 Battery Post w/diode Trio
- *6-35A Avalanche Diodes

Unit no.

HITACHI
 LR190-502B LR190-502C
 NISSAN
 23100-05D01

RH-115

- *119mm OD
- *M8 Battery Post
- *8-50A Avalanche Diodes

Unit no.

HITACHI
 LR280-708B

RH-116

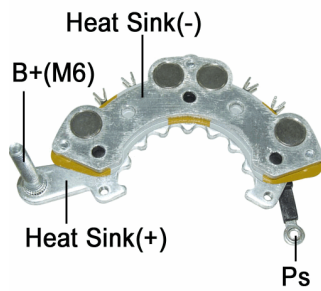

- *114mm OD
- *8-50 Avalanche Diodes
- *M6 Battery Post

Unit no.

HITACHI
 LR250-508

RH-117

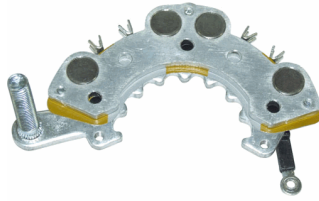

- *114mm OD
- *8-50 Avalanche Diodes
- *M8 Battery Post

Unit no.

HITACHI
LR250-707

RH-11C

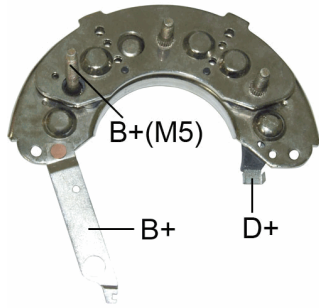

- *118mm OD
- *Copper Heat Sinks
- *Same as RH-01C except with Strap Terminal(66mm X 2.5mm)
- *M5 Battery Post w/diode Trio
- *6-35 Amp Diodes

Replaces

HITACHI :

L150-13203 L160-3320

NISSAN :

23230-06500 23230-Q4601

SUBARU :

49534-7101

Unit no.

HITACHI

LR155-15C	LR160-104	LR160-105	LR160-109	LR160-110	LR160-116
LR160-117	LR160-130	LR160-133	LR160-78	LR160-78B	LR160-82
LR160-82B	LR160-84	LR160-84B	LR160-93	LR170-14	LR170-18
LT150-113	LT150-114	LT150-123			
NISSAN					
23100-29R00	23100-D0201	23100-D0800	23100-D1700	23100-D3300	23100-H7205
23100-V0101	23100-V0102	23100-V0106	23100-V0107	23100-W5806	23100-W5807
SUBARU					
23700-AA00Q	23700-AA020	23700-AA160	42990-7000	42990-7010	42990-7300
42990-7320	42990-7330	42990-7340	42990-7400	42990-7500	42990-7600
42990-7700					

RH-120

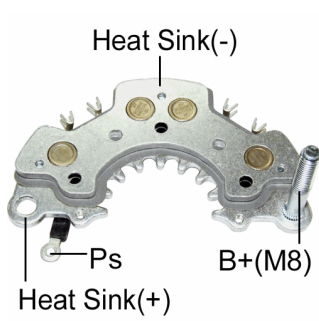

- *119mm OD
- *M8 Battery Post
- *8-35A Avalanche Diodes

Unit no.
 HITACHI
 LR1110-712

Used On
INFINITI
 QX4 2001-2002
NISSAN
 Pathfinder 2001-2002

RH-12C

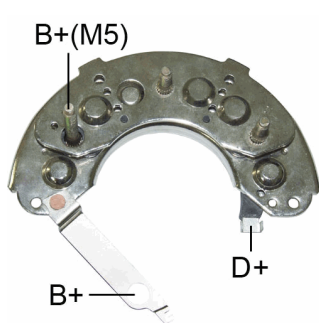

- *118mm OD
- *Copper Heat Sinks
- *Same as RH-01C except with Strap Terminal.(66mm X 8.6mm)
- *M5 Battery Post w/diode Trio
- *6-35 Amp Diodes

Replaces
HITACHI :
 L150-13203 L160-3320
NISSAN :
 23230-06500 23230-Q4601
SUBARU :
 49534-7101

Unit no.
 HITACHI
 LR155-15C LR160-104 LR160-105 LR160-109 LR160-110 LR160-116
 LR160-117 LR160-130 LR160-133 LR160-78 LR160-78B LR160-82
 LR160-82B LR160-84 LR160-84B LR160-93 LR170-14 LR170-18
 LT150-113 LT150-114 LT150-123
 NISSAN
 23100-29R00 23100-D0201 23100-D0800 23100-D1700 23100-D3300 23100-H7205
 23100-V0101 23100-V0102 23100-V0106 23100-V0107 23100-W5806 23100-W5807
 SUBARU
 23700-AA00Q 23700-AA020 23700-AA160 42990-7000 42990-7010 42990-7300
 42990-7320 42990-7330 42990-7340 42990-7400 42990-7500 42990-7600
 42990-7700

RH-13C

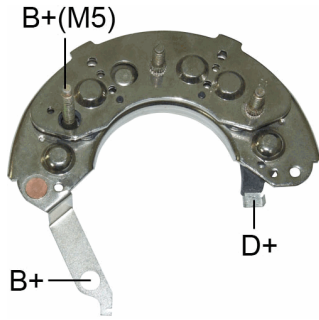

- *118mm OD
- *Copper Heat Sinks
- *Same as RH-01C except with Strap Terminal(56mm X 16.5mm)
- *M5 Battery Post w/diode Trio
- *6-35 Amp Diodes

Replaces

HITACHI :
L150-13203 L160-3320

NISSAN :
23230-06500 23230-Q4601

SUBARU :
49534-7101

Unit no.

HITACHI					
LR155-15C	LR160-104	LR160-105	LR160-109	LR160-110	LR160-116
LR160-117	LR160-130	LR160-133	LR160-78	LR160-78B	LR160-82
LR160-82B	LR160-84	LR160-84B	LR160-93	LR170-14	LR170-18
LT150-113	LT150-114	LT150-123			
NISSAN					
23100-29R00	23100-D0201	23100-D0800	23100-D1700	23100-D3300	23100-H7205
23100-V0101	23100-V0102	23100-V0106	23100-V0107	23100-W5806	23100-W5807
SUBARU					
23700-AA00Q	23700-AA020	23700-AA160	42990-7000	42990-7010	42990-7300
42990-7320	42990-7330	42990-7340	42990-7400	42990-7500	42990-7600
42990-7700					

RH-14C

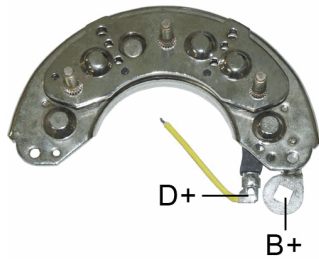

- *118mm OD
- *Copper Heat Sinks
- *w/diode Trio
- *6-35 Amp Diodes

Replaces

HITACHI :
L160-23201

ISUZU :
8-94116-432-0

NISSAN :
23232-W1705

Unit no.

HITACHI					
LR160-107B	LR160-108B	LR160-143B	LR160-144	LR160-146B	LR160-147F
LR160-148F	LR160-152F	LR160-164	LR160-67H	LR160-92C	LR160-96H
LR160-97B					
ISUZU					
8-94155-308-5	8-94155-309-5	8-94407-184-0	8-94407-185-0	8-94408-918-4	
NISSAN					
23099-W1705	23100-11H00	23100-17S05	23100-G3706	23100-G4100	23100-W1807
23100-W3405					

RH-15

- *118mm OD
- *Aluminum Heat Sinks
- *6-35 Amp Diodes
- *w/Diode Trios

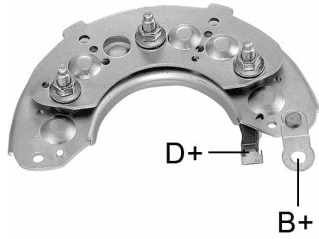

Replaces

HITACHI :

L160-23202 L160-43202

NISSAN :

23245-V7200

Unit no.

HITACHI

LR160-422B LR170-402 LR170-404 LR170-406B

NISSAN

23100-54A02 23100-V7204

RH-15C

- *118mm OD
- *Copper Heat Sinks
- *w/diode Trio
- *6-35 Amp Diodes

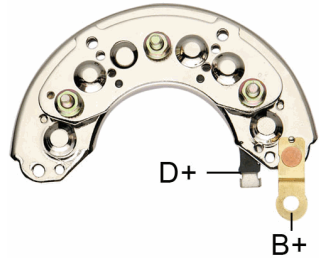

Replaces

HITACHI :

L160-23202 L160-43202

NISSAN :

23245-V7200

Unit no.

HITACHI

LR160-422B LR170-402 LR170-404 LR170-406B

NISSAN

23100-54A02 23100-V7204

RH-15N

- *118mm OD
- *Iron Heat Sinks
- *6-35 Amp Diodes
- *w/Diode Trios

Replaces

HITACHI :

L160-23202 L160-43202

NISSAN :

23245-V7200

Unit no.

HITACHI

LR160-422B LR170-402 LR170-404 LR170-406B

NISSAN

23100-54A02 23100-V7204

RH-16C

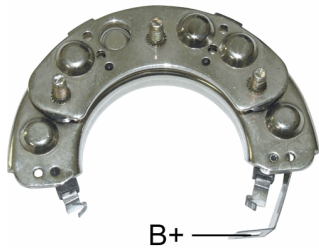

- *100mm OD
- *Copper Heat Sinks
- *6-35 Amp Diodes

Replaces

HITACHI :

L140-23201

ISUZU :

5-81218-029-0

MAZDA :

1456-24-510

Unit no.

HITACHI

LT135-63B LT140-109B LT140-109C LT140-110B

ISUZU

5-81200-266-4 5-81200-279-2

MAZDA

1456-18-300A

RH-17

*100mm OD
 *w/diode Trio
 *6-35 Amp Diodes

Replaces

HITACHI :
 L140-53201

ISUZU :
 8-94246-957-1

Unit no.

HITACHI
 LR140-131 LR140-131B

RH-17C

*100mm OD
 *Copper Heat Sinks
 *w/diode Trio
 *6-35 Amp Diodes

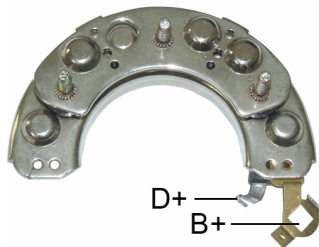

Replaces

HITACHI :
 L140-53201

ISUZU :
 8-94246-957-1

Unit no.

HITACHI
 LR140-131 LR140-131B

RH-18C

*100mm OD
 *Copper Heat Sinks
 *M5 Battery Post w/diode Trio
 *6-35 Amp Diodes

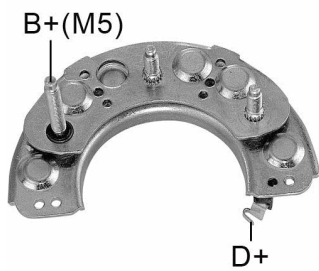

Replaces

HITACHI :
 L135-13208

NISSAN :
 23230-37504

Unit no.

HITACHI
 LR120-123 LR120-16B LR135-104 LR135-116 LR135-125 LR135-127
 LR135-128 LR135-95

RH-19C

- *100mm OD
- *Copper Heat Sinks
- *w/diode Trio
- *6-35 Amp Diodes

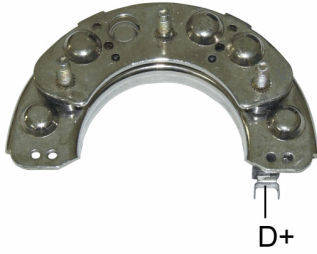

Replaces

HITACHI :
L135-6320

NISSAN :
23230-01B00

Unit no.

HITACHI		
LR140-132		LR140-133
NISSAN		
23100-01B05		23100-03B05

RH-20C

- *100mm OD
- *Copper Heat Sinks
- *M5 Battery Post w/diode Trio
- *6-35 Amp Diodes

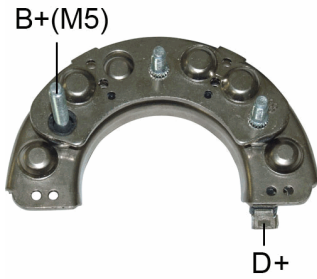

Replaces

HITACHI :
L135-3320

ISUZU :
8-42213-40

YANMAR :
L135-332000

Unit no.

HITACHI		
LR135-105	LR135-126	LR135-74

RH-21

*103mm OD
*8-35 Amp Diodes

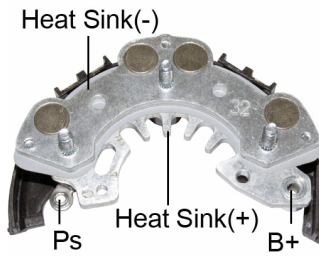

Replaces

HITACHI :
L170-33202

SUBARU :
23830-AA040

Unit no.

HITACHI
LR170-732B LR170-732C
SUBARU
23700-AA090

RH-22

*103mm OD
*M6 Battery Post w/diode Trio
*6-35 Amp Diodes

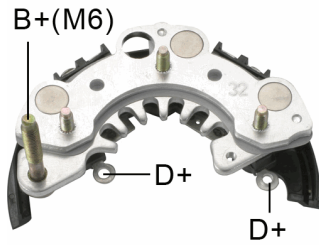

Replaces

HITACHI :
L170-43202 L170G-3320 L170G-6320 L180G-1320

NISSAN :
23230-77P00 23230-53F00 23230-12G01

Unit no.

HITACHI
LR170-734 LR170-734B LR170-739
NISSAN
23100-12B02 23100-88G00

RH-23

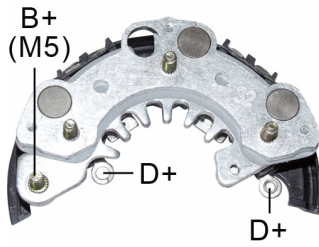

- *103mm OD
- *M5 Battery Post w/diode Trio
- *6-35 Amp Diodes
- *w/diode trio

Replaces

HITACHI :
L180-13202
NISSAN :
23230-64J00

Unit no.

HITACHI
LR160-723 LR160-723B LR180-725
NISSAN
23100-80G09R

RH-24

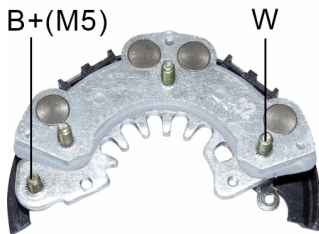

- *103mm OD
- *M5 Battery Post
- *8-35 Amp Diodes

Replaces

HITACHI :
L170-23203
NISSAN :
23230-50Y06

Unit no.

HITACHI
LR170-738 LR170-738B
NISSAN
23100-50Y06 23100-50Y09

RH-25

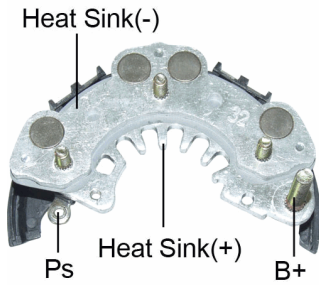

- *103mm OD
- *M6 Battery Post
- *8-35 Amp Diodes

Replaces

HITACHI :
L170G-2320

NISSAN :
23230-0E705

Unit no.

HITACHI
LR170-738C

NISSAN
23100-0E705

RH-26

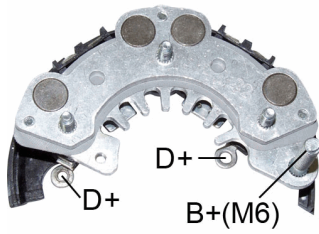

- *103mm OD
- *M6 Battery Post w/diode Trio
- *8-35 Amp Diodes

Replaces

HITACHI :
L170G-1320

NISSAN :
23230-50Y09

Unit no.

HITACHI
LR160-726 LR170-738B

NISSAN
23100-50Y09

RH-27

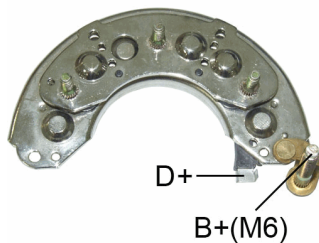

- *118mm OD
- *Aluminum Heat Sink
- *M6 Battery Post w/diode Trio
- *6-35 Amp Diodes

Replaces

HITACHI :
L170-93202 L170G-73201 L170G-8320

Unit no.

HITACHI
LR170-417 LR170-417C LR170-417E LR170-417F

RH-27C

- *118mm OD
- *Copper Heat Sink
- *M6 Battery Post w/diode Trio
- *6-35 Amp Diodes

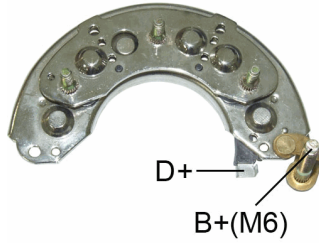

Replaces

HITACHI :

L170-93202 L170G-73201 L170G-8320

Unit no.

HITACHI

LR170-417B LR170-417C LR170-417E LR170-417F

RH-28

- *103mm OD
- *M6 Battery Post
- *6-35 Amp Diodes

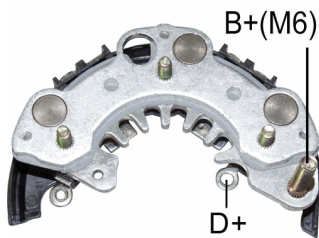

Unit no.

HITACHI

LR150-711

RH-29

- *103mm OD
- *M5 Battery Post
- *6-35 Amp Diodes

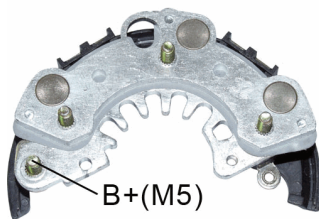

Replaces

HITACHI :

L180G-7320

NISSAN :

23230-1E400 23230-56G00

Unit no.

HITACHI

LR170-739 LR180-725B LR180-725C LR180-736B

NISSAN

23100-1E400

RH-30

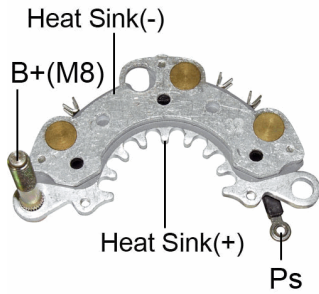

- *114mm OD
- *M8 Battery Post
- *6-35 Amp Diodes

Unit no.

HITACHI
LR170-745

RH-31

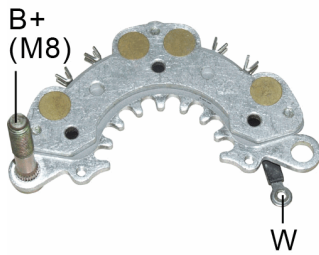

- *114mm OD
- *M8 Battery Post
- *8-35 Amp Diodes

Unit no.

HITACHI
LR170-748 LR170-748B LR180-751 LR190-729

RH-32

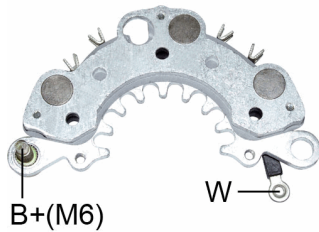

- *114mm OD
- *M6 Battery Post
- *6-35 Amp Diodes

Unit no.

HITACHI
LR180-741H LR180-744
NISSAN
23100-1E800

RH-33

- *114mm OD
- *M6 Battery Post
- *8-35 Amp Diodes

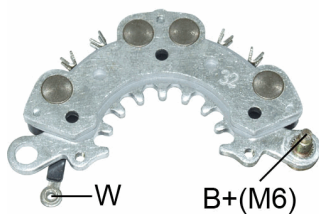

Replaces

HITACHI :

L190G-33204 L190G-63205

SUBARU :

23830-AA100 23830-AA140 23830-AA180

Unit no.

HITACHI

LR190-724

NISSAN

23100-70F05

RH-34

- *119mm OD
- *M8 Battery Post w/diode Trio
- *6-35 Amp Diodes

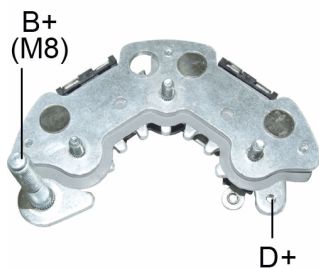

Replaces

HITACHI :

L1110G-748B

NISSAN :

23230-60401

Unit no.

HITACHI

LR1100-702

LR1100-702C

NISSAN

23100-61U00

RH-35

- *119mm OD
- *M6 Battery Post
- *8-40A Avalanche Diodes

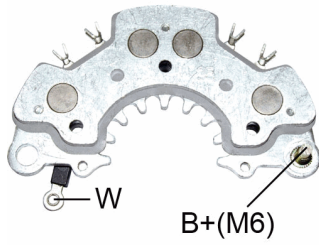

Replaces

HITACHI :
L1110G-4320 L1125G-2320

Unit no.

HITACHI
LR1110-705 LR1125-702B
NISSAN
23100-31U01 23100-31U02

RH-36

- *119mm OD
- *M8 Battery Post w/diode Trio
- *8-35 Amp Diodes

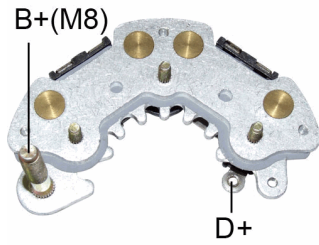

Replaces

HITACHI :
L1110-1320

Unit no.

HITACHI
LR1110-701 LR1110-702
NISSAN
23100-60U00 23100-91U00

RH-37

- *119mm OD
- *M8 Battery Post w/o diode Trio
- *8-35 Amp Diodes

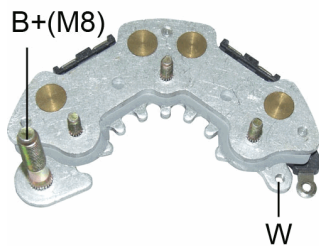

Replaces

HITACHI :
L1110G-3320

NISSAN :
23230-0P605

Unit no.

HITACHI
LR1110-701B
NISSAN
23100-60U02

RH-38

- *119mm OD
- *M8 Battery Post w/diode Trio
- *6-35 Amp Diodes

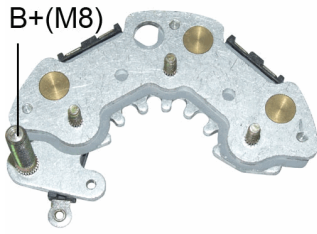

Replaces

HITACHI :
84201040 L195G-1320

NISSAN :
23230-97E02

Unit no.

HITACHI
LR195-701
NISSAN
23100-97E01

RH-39C

- *100mm OD
- *Copper Heat Sinks
- *w/diode Trio
- *6-35 Amp Diodes

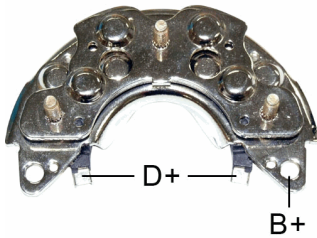

Replaces

HITACHI :
L170-9320

NISSAN :
23230-51S00

Unit no.

HITACHI		
LR150-704	LR150-715	LR170-716B
NISSAN		
23100-51S00	23100-53A00	23100-D4405

RH-40C

- *100mm OD
- *Copper Heat Sinks
- *w/diode Trio
- *8-35 Amp Diodes

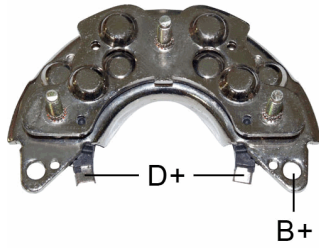

Replaces

HITACHI :
L165-6320 L165-7320 L170-7302

NISSAN :
23230-77A00

SUBARU :
23830-AA020

Unit no.

HITACHI
LR165-704B LR165-707B LR180-715

NISSAN
23100-77A00

SUBARU
23700-AA150

RH-41C

- *100mm OD
- *Copper Heat Sinks
- *M6 Battery Post w/diode Trio
- *6-35 Amp Diodes

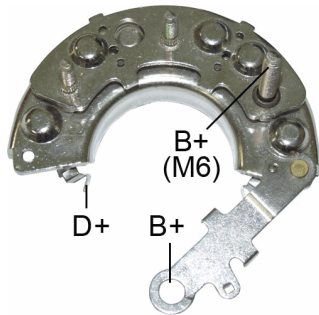

Replaces

HITACHI :
L165-3320

SUBARU :
23830-AA000

Unit no.

HITACHI
LR165-704
SUBARU
23700-AA050

RH-42C

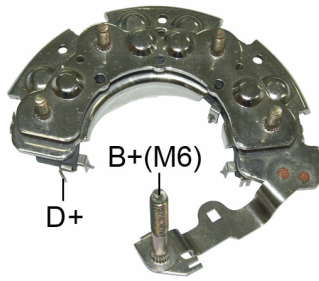

- *113mm OD
- *Copper Heat Sinks
- *M6 Battery Post w/diode Trio
- *6-35 Amp Diodes

Replaces

HITACHI :

L180-2320 L180-6320

NISSAN :

23230-16E05 23230-26E60

Unit no.

HITACHI

LR170-713 LR170-721 LR180-704 LR180-715 LR190-704

NISSAN

23100-16E05 23100-26E05 23100-26E61 23100-30R00 23100-F6101

RH-43C

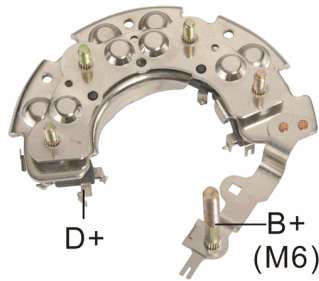

- *113mm OD
- *Copper Heat Sinks
- *M6 Battery Post w/diode Trio
- *8-35 Amp Diodes

Replaces

HITACHI :

L190-1320 L190-3320 L190-5320

NISSAN :

23230-F6101 23230-V4360

Unit no.

HITACHI

LR190-701B LR190-702B LR190-702C LR190-703B LR190-704B LR190-708C

LR190-711

NISSAN

23100-85E00 23100-V4060 23100-V4360 23100-V4365 23100-V4560

RH-44C

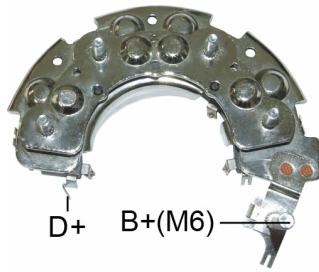

- *113mm OD
- *Copper Heat Sinks
- *M6 Battery Post w/diode Trio
- *8-35 Amp Diodes

Replaces

HITACHI :

L180-93201 L190-4320

NISSAN :

23230-30P00 23230-F6500

Unit no.

HITACHI

LR180-724 LR190-706 LR190-707

NISSAN

23100-30P00

RH-45C

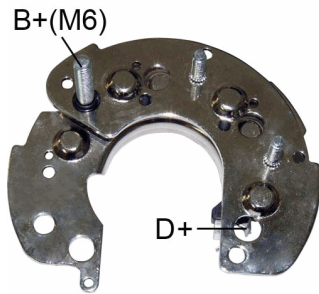

- *103mm OD
- *Copper Heat Sinks
- *M6 Battery Post w/diode Trio
- *6-35 Amp Diodes

Replaces

NISSAN :

23230-05P01

Unit no.

HITACHI

LR170-701B LR170-702B

NISSAN

23100-05P01 23100-15P01

RH-46C

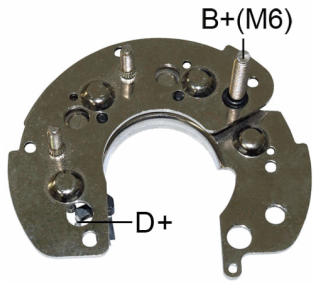

- *104mm OD
- *Copper Heat Sinks
- *M6 Battery Post w/diode Trio
- *6-35 Amp Diodes

Replaces

HITACHI :
L170-2320

NISSAN :
23230-02E00

Unit no.

HITACHI

LR160-708

LR160-709

LR160-710

NISSAN

23100-02E00

23100-02E05

RH-47C

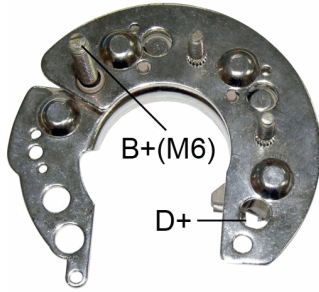

- *95mm OD
- *Copper Heat Sinks
- *M6 Battery Post w/diode Trio
- *6-35 Amp Diodes

Replaces

HITACHI :
L150-73202

L170-93202

Unit no.

HITACHI

LR150-703

LR150-99

RH-48

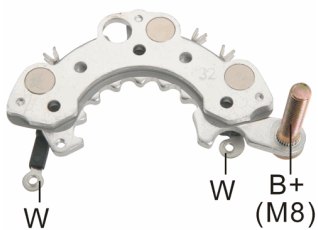

- *115mm OD
- *M8 Battery Post
- *6-35 Amp Diodes

Replaces

HITACHI :
L170G-3319

Unit no.

LUCAS

LRB303

RH-49

*6-35 Amp Diodes

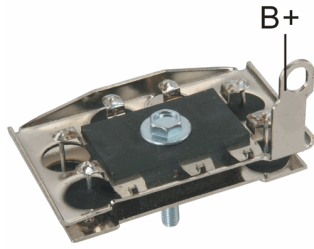

Replaces

HITACHI :

L125-6320	L125-8320	L140-6320	L140-7320	L140-9320	L160-13201
-----------	-----------	-----------	-----------	-----------	------------

ISUZU :

5-81200-084-0	5-81200-114-0	5-81218-001-0	5-81218-021-0	5-81218-022-0	8-94206-081-0
9-82231-619-0					

LUCAS :

21511125	UBJ102				
----------	--------	--	--	--	--

NISSAN :

23230-H0300	23230-U0100	23232-B8000	23232-E6601	23232-H6200	23232-N3300
23232-U0102					

SUBARU :

31441-00-808

Unit no.

HITACHI

LR135-30	LR135-35	LR135-73	LR150-05	LR150-21	LR150-22
LR150-23	LR150-26	LT115-52	LT120-05	LT120-07	LT120-21
LT130-81	LT130-89	LT135-17	LT135-22	LT135-24B	LT135-26
LT135-30	LT135-35	LT135-35C	LT135-38C	LT135-54	LT135-68
LT135-73	LT135-73B	LT150-03	LT150-05	LT150-10	LT150-21
LT150-22	LT150-23	LT150-26	LT160-32	LT210-01	LT215-27

ISEKI

6581-200-272-0

ISUZU

5-81200-101-1	5-81200-109-0	5-81200-114-0	5-81200-170-0	8-94206-081-0	9-82200-763-0
9-82200-764-0					

NISSAN

012149277200	012475677200	18504-6071	23100-0100	23100-61700	23100-77A00
23100-80210	23100-80W00	23100-90060	23100-91004	23100-A4601	23100-A4602
23100-C0403	23100-C6000	23100-H0300	23100-H7203	23100-L1802	23100-M0400
23100-M0401	23100-M0402	23100-P0102	23100-P0111	23100-P0112	23100-P4502
23100-Q4500	23100-U0100	23100-U0101	23100-U0102	23100-U0103	23100-U5802

SUBARU

32990-53300

RH-50

*6-35 Amp Diodes

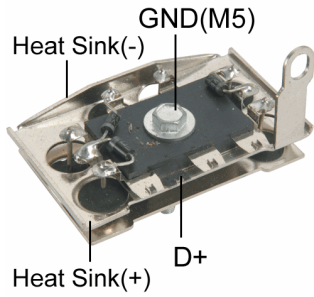

Replaces

LUCAS :

21511112 UBJ105

NISSAN :

23230-E3200

Unit no.

HITACHI

LR140-130P LR140-402 LR150-02 LR150-11 LR150-11A LR150-421C

LR150-432 LR150-434B LR225-402 LR225-407

NISSAN

23100-P2500 23100-P2501 23100-U9500

RH-51

*6-35 Amp Diodes

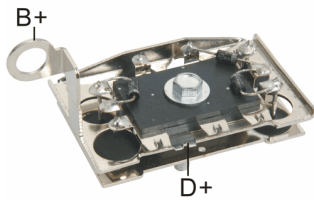

Replaces

HITACHI :

L135N-13201 L150N-13202

LUCAS :

21511119

MAGNETI MARELLI :

940038249

NISSAN :

23230-B9800 23230-P2501

Unit no.

HITACHI

LR135-36 LR135-44 LR135-51 LR135-53

NISSAN

23100-B9800 23100-B9801 23100-H7700 23100-H7701 23100-P2506

RH-53C

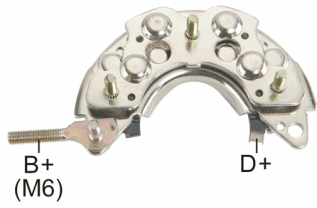

- *100mm OD
- *Copper Heat Sinks
- *M6 Battery Post w/diode Trio
- *8-35 Amp Diodes

Replaces

HITACHI :
L170G-73202

RH-58C

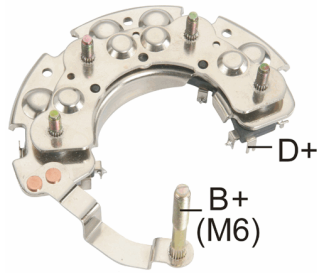

- *119mm OD
- *Copper Heat Sinks
- *M6 Battery Post w/diode Trio
- *6-35 Amp Diodes

Replaces

HITACHI :
L180G-8320
ISUZU :
8-97062651-0

Unit no.

HITACHI
LR180-501 LR180-501B

RH-59C

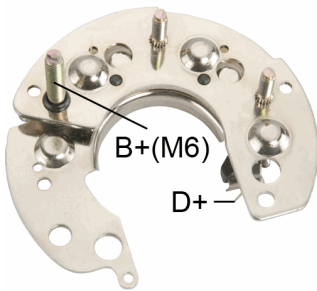

- *98mm OD
- *Copper Heat Sinks
- *M6 Battery Post w/diode Trio
- *6-35 Amp Diodes

Replaces

HITACHI :
L160-33201

Unit no.

HITACHI
LR160-702B LR160-703B

RH-60

- *118mm OD
- *M6 Battery Post
- *6-35Amp Diodes

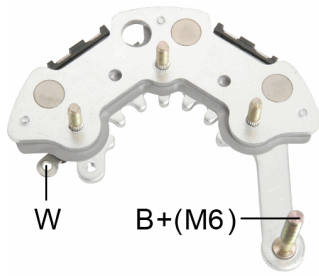

Replaces

HITACHI :
L190G-33201

Unit no.

HITACHI
LR170-502C LR190-505E LR190-511 LR190-511B

RH-61

- *118mm OD
- *M8 Battery Post
- *8-35 Amp Diodes

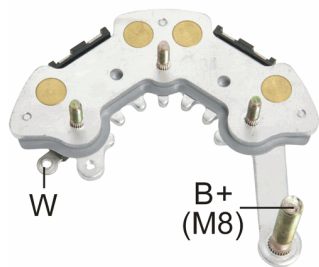

Replaces

HITACHI :
L1100G-5320

Unit no.

HITACHI
LR190-512C
NISSAN
23100-5C310

RH-62

- *118mm OD
- *M6 Battery Post
- *6-35 Amp Diodes

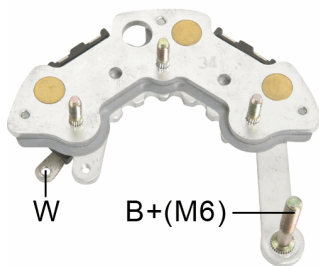

Unit no.

NISSAN
23100-56G00

RH-63

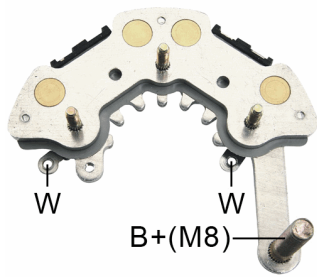

- *118mm OD
- *w/two terminals
- *M8 Battery Post
- *8-35 Amp Diodes

Unit no.

HITACHI
LR1100-501B

RH-65

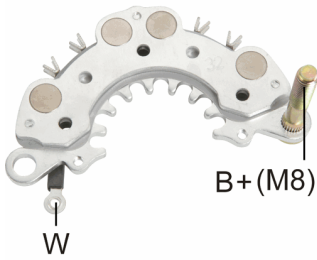

- *114mm OD
- *M8 Battery Post
- *8-35 Amp Diodes

Replaces

HITACHI :
L160G-53201

Unit no.

HITACHI
LR160-728B LR160-728C LR160-732B LR160-732C LR235-705

RH-66

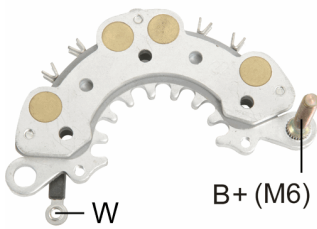

- *114mm OD
- *M6 Battery Post
- *8-35 Amp Diodes

Unit no.

HITACHI
LR170-755
ISUZU
8-97130-776-0

RH-66A

- *114mm OD
- *M6 Battery Post
- *8-50A Avalanche Diodes

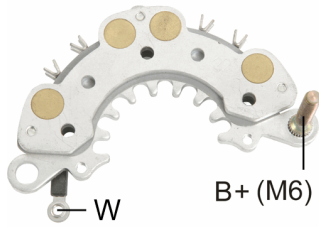

Unit no.

HITACHI
LR170-755

RH-67A

- *110mm OD
- *M6 Battery Post
- *6-50A Avalanche Diodes

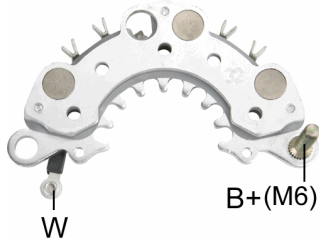

Unit no.

HITACHI
LR160-730C LR160-731
ISUZU
8-97130-752-0

RH-68

- *120mm OD
- *M8 Battery Post w/o diode Trio
- *8-35A Avalanche Diodes
- *For Use on 70A Alternators

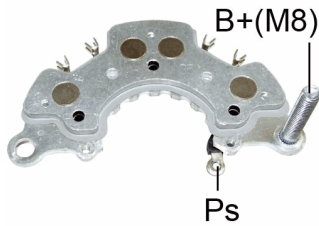

Unit no.

HITACHI
LR1100-502E LR1100-502F LR1100-502G LR1100-502J LR170-509C LR170-509E
LR170-509F LR170-509G LR170-509H

RH-69

- *114mm OD
- *M6 Battery Post
- *8-50A Avarance Diodes

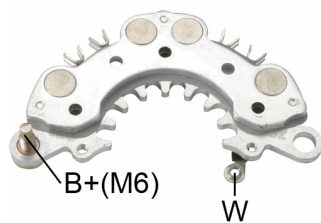

Unit no.

HITACHI	
LR1100-722	LR170-709B
NISSAN	
23100-5M000	23100-9E000

RH-70

- *114mm OD
- *M6 Battery Post
- *8-35 Amp Diodes

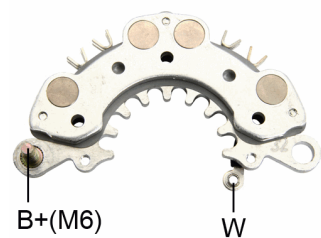

Unit no.

HITACHI	
LR170-757B	
NISSAN	
23100-3S500	

RH-71

- *120mm OD
- *M6 Battery Post
- *6-50A Avalanche Diodes

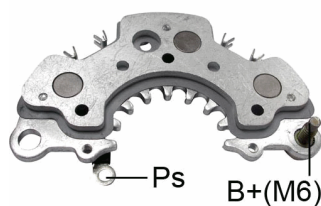

Replaces

HITACHI :
L1100G-23201

Unit no.

HITACHI	
LR1100-711B	

RH-72

- *115mm OD
- *M8 Battery Post
- *Same as RH-48 but w/6-50A Avalanche Diodes

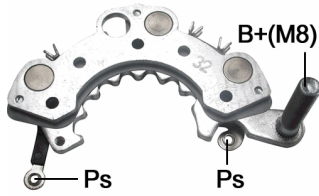

Replaces

HITACHI :
L170G-3319

Unit no.

HITACHI
LRB303

RH-73

- *120mm OD
- *M8 Battery Post w/o diode Trio
- *8-50A Avalanche Diodes
- *For Use on 100A Alternators

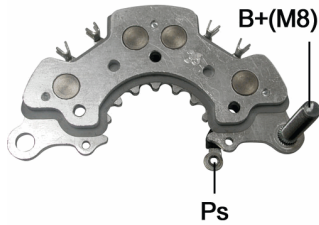

Unit no.

HITACHI
LR1100-503B LR1100-507B LR1100-503C LR1100-503E LR1100-507C LR1100-508
LR1100-508B LR1100-508C LR1100-508F

RH-74A

- *8-50 Amp Diodes
- *M6 Battery Post
- *w/Diode Trios

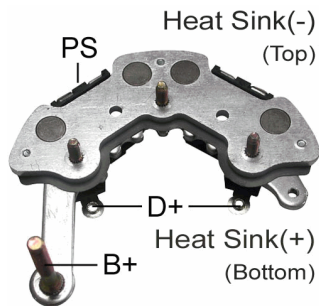

Unit no.

HITACHI
LR250-502C LR250-507 LR250-507C
ISUZU
8-97075-883-2 8-97148-496-0 8-97148-496-1

RH-75

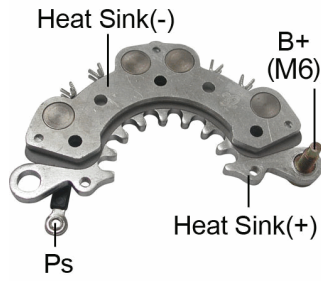

- *124mm OD
- *M6 Battery Post
- *8-35A Avalanche Diodes

Replaces

HITACHI :

L190G-33204

SUBARU :

23830-AA100 23830-AA140

Unit no.

HITACHI

LR185-701 LR185-701C LR185-702

RH-76

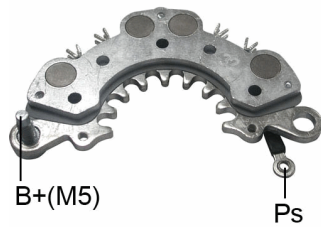

- *110mm OD
- *M5 Battery Post w/o diode Trio
- *8-35 Amp Diodes

Unit no.

HITACHI

LR190-737 LR190-737E

NISSAN

23100-0W001

RH-77

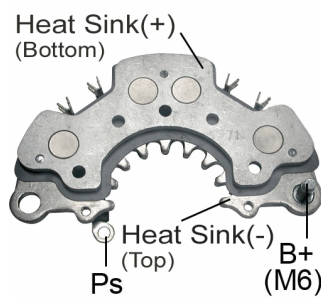

- *120mm OD
- *M6 Battery Post
- *8-50A Avalanche Diodes

Replaces

HITACHI :

L1110G-23201 L1110G-6320 L1110G-73082 L1110G-8320 L1100G-23201 L1100G-6320

NISSAN :

23230-0L700

Unit no.

HITACHI

LR1100-703B LR1100-711 LR1100-711B LR1100-725 LR1100-725B LR1100-725C

LR1110-707F LR1110-707G LR1110-707H LR1110-709B LR1110-710F

NISSAN

23100-L701

RH-78

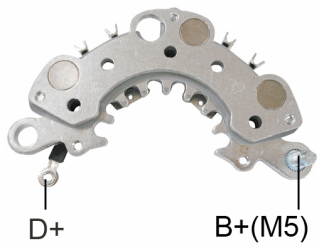

- *114mm OD
- *M5 Battery Post
- *6-35 Amp Diodes

Unit no.
KIA
OK012-18300 OK241-18300

RH-79

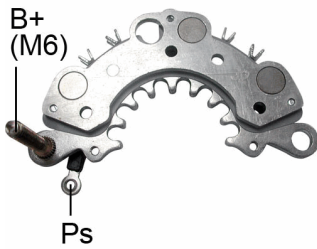

- *110mm OD
- *M6 Battery Post
- *6-50A Avalanche Diodes
- *w/o Diode Trios

Replaces
HITACHI :
LR160-729C

RH-80

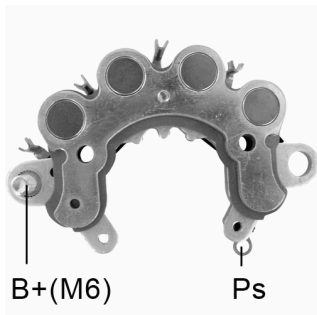

- *M6 Battery Post
- *8-35A Avalanche Diodes

Unit no.
HITACHI
LR165-713

RH-82

- *114mm OD
- *M6 Battery Post
- *8-35 Amp Diodes

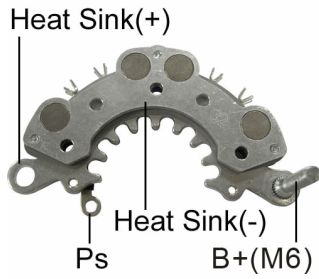

Replaces

HITACHI :
234829

Unit no.

HITACHI
LR190-744
ISUZU
29027-68300 89720-43320

RH-83

- *114mm OD
- *M6 Battery Post
- *8-50A Avalanche Diodes

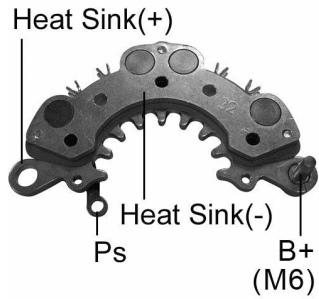

Unit no.

HITACHI
LR190-742
SUBARU
23700-AA31A

RH-85

- *127mm OD
- *M8 Battery Post w/o diode Trio
- *6-50A Avalanche Diodes

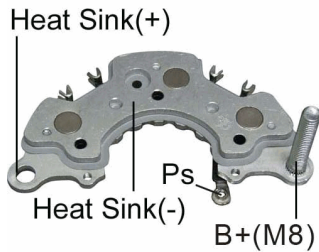

Unit no.

HITACHI
LR1100-502MD

RH-91

- *120mm OD
- *M6 Battery Post
- *6-35A Avalanche Diodes

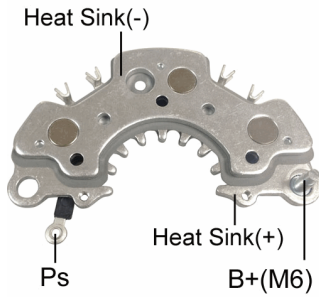

Unit no.

HITACHI		
LR1110-713V	LR1110-713C	
NISSAN		
23100-JA02C	23100-AU400	23100-AU40D

Used On

NISSAN		
ROUGE 2.5 4Cyl.		2008-2012

RH-92

- *95mm OD
- *M6 Battery Post w/diode trio
- *8-50 Amp Diodes

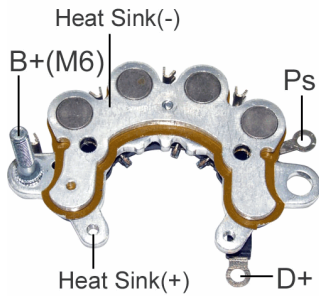

Unit no.

HITACHI	
LR160-735B	LR160-735
YANMAR	
123900-77210	

RH-93

- *114mm OD
- *M8 Battery Post
- *8-35 Avalanche Diodes

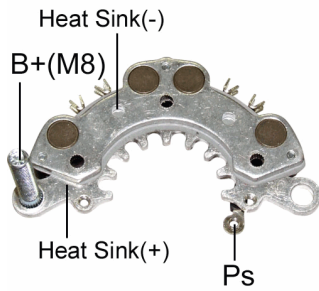

Unit no.

HITACHI	
LR1100-715	

RH-94

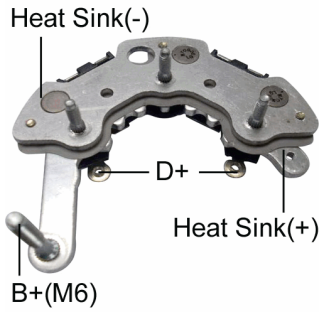

- *119mm OD
- *M6 Battery Post w/ diode Trio
- *6-50 Amp Diodes

Unit no.

NISSAN
23100-0T002

RH-95

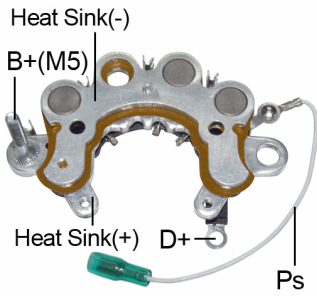

- *95mm OD
- *M5 Battery Post
- *6-35 Amp Diodes

Unit no.

HITACHI
LR140-721 LR140-721B LR140-721C
YANMAR
129612-77230

RH-97

- *119mm OD
- *M8 Battery Post w/diode Trio
- *8-35A Avalanche Diodes

Unit no.

HITACHI
LR1110-502

RV-H001

*Complete set with VR-H2000-53 + RH-72

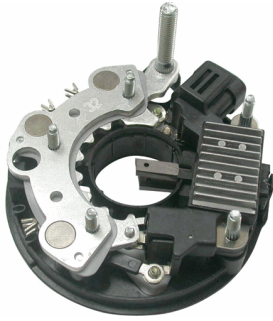

Unit no.

HITACHI
LR170-505

RV-H002

*Complete set with VR-H2000-50 + RH-73



Unit no.

HITACHI
LR1100-502E

RV-H003B

*Complete set with VR-H2000-86B + RH-74



Unit no.

HITACHI		
LR250-502C	LR250-507	LR250-507C
ISUZU		
8-97075-883-2	8-97148-496-0	8-97148-496-1

RV-H004

*Complete set with VR-H2000-57 + RH-80

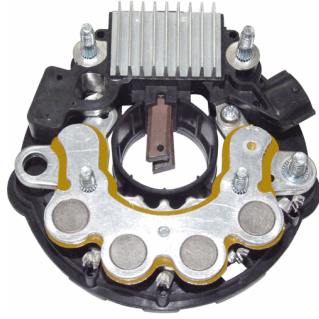

Unit no.

HITACHI
LR165-713

RV-H005A

* Complete set with VR-H2000-29A-2+ RH-04N
* Voltage regulator with capacitor

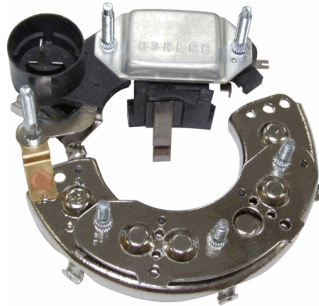

Unit no.

HITACHI
LR150-431

RV-H005BA

* Complete set with VR-H2000-29BA-2 + RH-04N
* Voltage regulator with capacitor

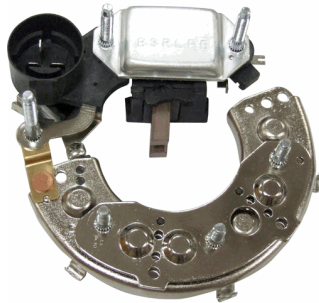

Unit no.

HITACHI
LR270-05

RV-H008

*Complete set with VR-H2000-64 + RH-85



Unit no.
HITACHI
LR1100-502MD

RV-H009

*Complete set with VR-H2000-24 + RH-28



Unit no.
HITACHI
LR150-711

RV-H013

*Complete set with VR-H2000-65 + RH-58C

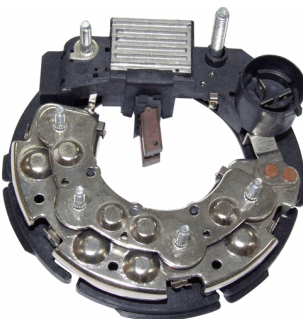

Unit no.
HITACHI
LR180-502R

RV-H017B

*Complete set with VR-H2000-70B + RH-111

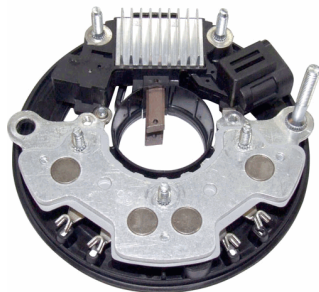

Unit no.

HITACHI

LR280-501

LR280-506

LR280-508

ISUZU

8-97351-574-0

8-97248-914-1

8-97332-502-0

RV-H018

*Complete set with VR-H2000-16 + RH-25

Unit no.

HITACHI

LR170-738C

NISSAN

23100-0E705

RV-H021

*Complete set with VR-H2000-73+RH-91

Unit no.

HITACHI

LR1110-725

LR1110-725B

RV-H022

*Complete set with VR-H2000-72 + RH-92

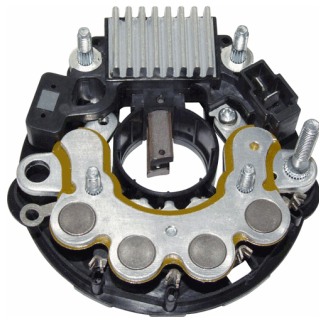

Unit no.

HITACHI

LR160-735

LR160-735B

YANMAR

123900-77210

RV-H023

*Complete set with VR-H2000-74 + RH-93

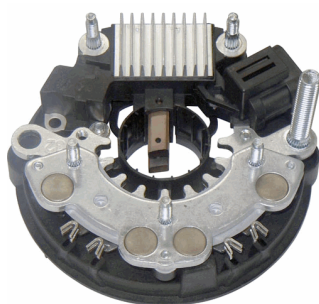

Unit no.

HITACHI

LR1100-715

RV-H024B

*Complete set with VR-H2000-75B + RH-94



Unit no.

NISSAN

23100-0T002

Used On

NISSAN

Cabstar

MK120

1997-

RV-H030

*Complete set with VR-H2000-64+RH-73

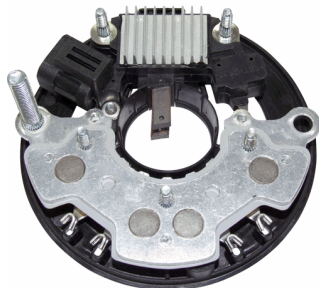

Unit no.

HITACHI
LR1100-508
ISUZU
89736-95070

Used On

OPEL

Astra 1.7L

2004-on

RV-H034

*Complete set with VR-H2000-44 + RH-69

Unit no.

HITACHI
LR1100-722
NISSAN
23100-5M000

Used On

NISSAN

Sentra 1.8L

2000-2001

RV-H035

*Complete set with VR-H2000-62 + RH-65

Unit no.

HITACHI		
LR160-728	LR160-728B	
NISSAN		
23100-7T400	23100-7T402	23100-7T403

RV-H040

*Complete set with VR-H2000-28 + RH-35

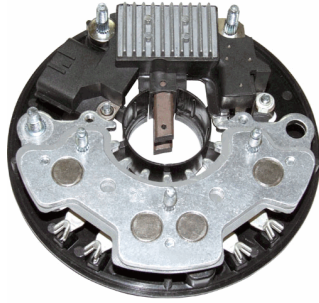

Replaces

HITACHI :
L1100G-3340 L1100G-9340

NISSAN :
23215-31U05

Unit no.

HITACHI
LR1110-705
NISSAN
23100-31U01 23100-31U02

RV-H046

*Complete set with VR-H2000-42 + RH-32

Unit no.

HITACHI
LR160-727 LR180-744

RV-H047

*Complete set with VR-H2000-84 + RH-91



Unit no.

HITACHI
LR1110-713V
NISSAN
23100-AU400

Used On

NISSAN

X-Trail 4 Cyl 2.5L	2005-2006
Primera 2000	2002-2010
Primera 2000 16V	2002-2010

RV-H049B

*Complete set with VR-H2000-70B + RH-115

Unit no.

HITACHI
LR280-708B

RV-H052B

*Complete set with VR-H2000-80B + RH-116 (M6 B+)

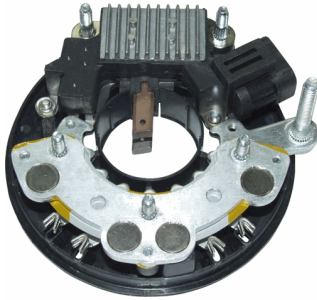

Unit no.

HITACHI
LR250-508

RV-H053B

*Complete set with VR-H2000-80B + RH-117 (M8 B+)

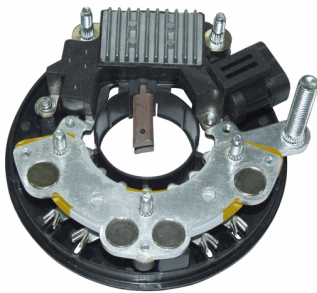

Unit no.

HITACHI
LR150-707

RV-H055N

*Complete set with VR-H2000-30+ RH-15N

Unit no.

HITACHI

LR170-406B

LR160-422B

RV-H056

*Complete set with VR-H2000-72 + RH-95

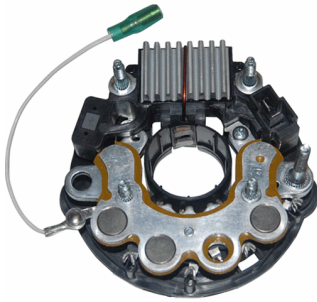

Unit no.

HITACHI

LR140-721

LR140-721B

LR140-721C

LR140-721D

RK-04

Heat Sink(-)

- *110mm OD
- *8-50A Avalanche Diodes
- *M8 Battery Post

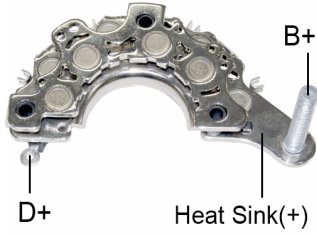

Unit no.

HYUNDAI
37300-27011
POONG SUNG
02131-9111

Used On

HYUNDAI

Elantra 2.0L 16V	2001-
Santa FE 2.0L 16V	2001-
Tuscon 2,0L	2004-

KIA

Carena 2.0L	2002-
Sportage 2.0L	2005-

RM-191H

- *100mm Mtg. Length
- *8-30 Amp Diodes

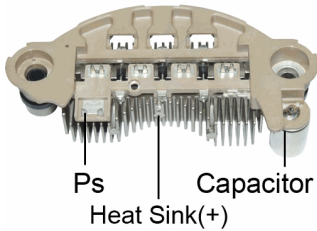

Unit no.

KIA
37300-4A110 37300-4A111 37300-4A112

RM-197

- *115mm OD
- *M8 Battery Post
- *6-50A Avalanche Diodes

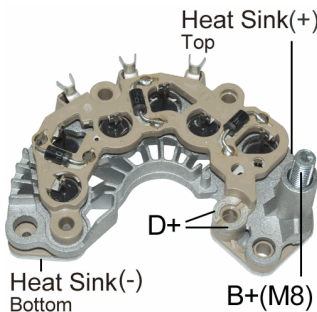

Unit no.

HYUNDAI
37300-23720

RK-01

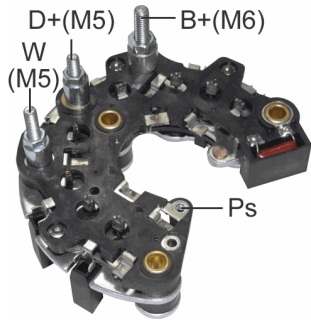

- *M6 Battery Post
- *8-50A Avalanche Diodes
- *w/diode trio

Replaces

ISKRA :
16903507

Unit no.

ISKRA

11201597

11201666

11201667

11201675

11201758

AAK5114

AAK5115

AAK5118

AAK5132

RK-02

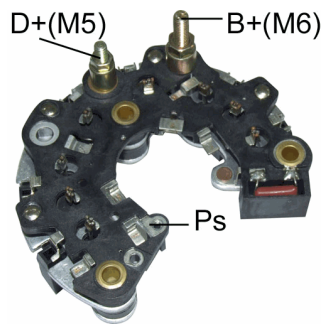

- *M6 Battery Post
- *8-50A Avalanche Diodes
- *w/ diode trio

Replaces

ISKRA :
16903314

Unit no.

ISKRA

11201440

11201490

RK-05

*110mm OD
 *8-50A Avalanche Diodes

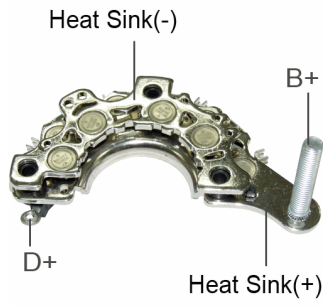

Replaces

POONG SUNG :
 RES14703

Unit no.

HYUNDAI	
37300-27010	37300-27012
POONG SUNG	
02131-9112	02131-9110

RI-10H

*6-35 Amp Diodes
*110mm OD



Replaces

LADA :

2108370131 2108370132

Unit no.

LADA

2101.3701.005 373701114V55AAL35

RC-01HV



- *6-50 Amp Diodes
- *Positive
- *4884J
- *4806J
- *4900J

Replaces

LEECE NEVILLE :
101387 A051101387

RC-02HV



- *6-50 Amp Diodes
- *Positive
- *4884J
- *4860J
- *4900J

Replaces

LEECE NEVILLE :
101441 A051101441

RC-03H

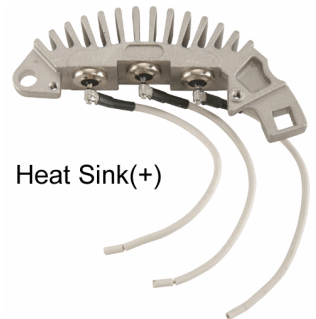

- *6-35 Amp Diodes
- *Positive
- *JA Series Alternators
- *JB Series Alternators

Replaces

LEECE NEVILLE :
71180

RC-04H



- *6-35 Amp Diodes
- *Negative
- *JA Series Alternators
- *JB Series Alternators

Replaces

LEECE NEVILLE :
71181

RC-05HV

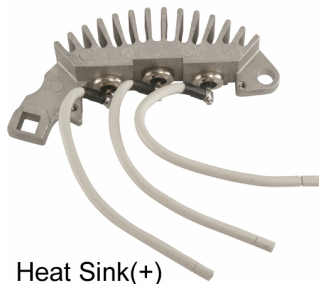

- *6-50 Amp Diodes
- *Positive
- *J, JB Series Alternators

Replaces

LEECE NEVILLE :
79193

RC-06HV

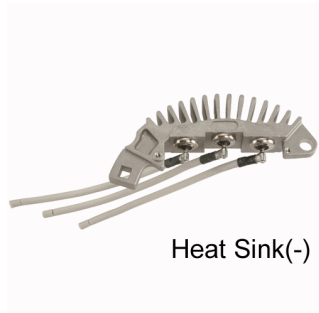

- *6-50 Amp Diodes
- *Negative
- *J, JB Series Alternators

Replaces

LEECE NEVILLE :
79415

RC-07HV



- *6-50 Amp Diodes
- *Positive
- *2800JB
- *7804-7808 J Series Alternators

Replaces

LEECE NEVILLE :
97084

RC-08HV



- *6-50 Amp Diodes
- *Negative
- *2800JB
- *7804-7808 J Series Alternators

Replaces

LEECE NEVILLE :
97085

RC-17HD

- *6-70 Amp Diodes
- *Negative
- *4800 Series Alternator

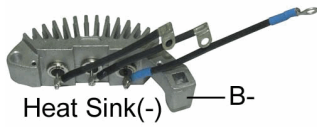

Unit no. [Redacted]
LEECE NEVILLE
A0014834LC

RC-18HD

- *6-70 Amp Diodes
- *Positive
- *4800 Series Alternator

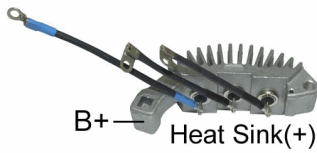

Unit no. [Redacted]
LEECE NEVILLE
A0014834LC

RL-01H

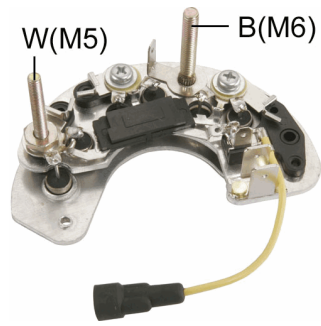

- *115mm OD
- *M6 Battery Post
- *6-35 Amp Diodes

Replaces

CASE :
K262267

FORD :
E7NN-10304AA

LUCAS :

84201	84422	84454	84455	84499	UBB133
UBB135	UBB141	UBB143	84454010	84499010	84885010
66201570	84457	84855	84885	84889	UBB144

MAGNETI MARELLI :
84454

MASSEY FERGUSON :
1897700M91 3474648M91 3477529M91

PERKINS :
28710253

ROVER :
BAU4920 BAU5266 BAU5813 RTC5045

RVI :
5430021884

Unit no.

LUCAS

24145	24156	24157	24158	24161	24169
24198	24199	24200	24208	24209	24228
24231	24232	24240	24241	24242	24245
24246	24249	24256	24273	24274	

RL-02H

*115mm OD
*6-35 Amp Diodes

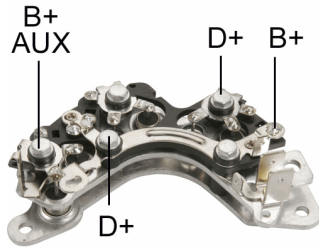

Replaces

CASE :

245537C1

FIAT :

9937250

FORD :

81AB-10304AA 81DB-10304BA 82BB-10304AA E3NN-10304AA

LUCAS :

83563	83642	83643	84719	84758	84759
UBB115	UBB122	UBB129			

MASSEY FERGUSON :

1897267M1

PERKINS :

28710225 28710236

ROVER :

BAU1825L

RVI :

5430020198 5430020791

Unit no.

LUCAS

23983	23984	23985	23986	24023	24024
24026	24027	24028	24035	24036	24037
24051	24052	24058	24059	24061	24062
24063	24064	24065	24066	24082	24083
24085	24087	24092	24094	24095	24099
24112	24131	24132	24134	24135	24144
24147	24170	24179	24180	24181	24182
24183	24184	24185	24210	24211	24237

RL-03H

*115mm OD
*M6 Battery Post
*6-35 Amp Diodes

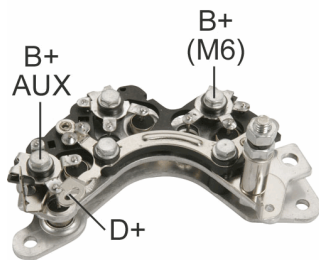

Replaces

LUCAS :

83565	83670	83757	83784	84760	84761
UBB117	UBB120	UBB124			

Unit no.

LUCAS

24041	24060	24167	24168	24171	60921062
-------	-------	-------	-------	-------	----------

RL-04H

*115mm OD
*6-35 Amp Diodes

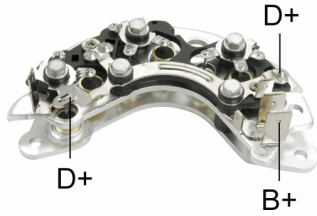

Replaces

FORD :

81AB-10304BA 81AB-10304CA

LUCAS :

83567 83623 83645 84720 84767 UBB116
UBB121 UBB127

MASSEY FERGUSON :

1895344M1 1897344M1

PERKINS :

28710243

ROVER :

BAU1996 BAU2191 RTC3213

Unit no.

LUCAS

23996	23997	23998	23999	24020	24025
24034	24053	24054	24067	24069	24070
24071	24072	24079	24086	24088	24089
24090	24096	24098	24114	24115	24116
24117	24118	24119	24128	24136	24137
24149	24151	24153	24164	24165	24177
24178	24189	24190	24191	24192	24204

RL-05H

*115mm OD
*6-35 Amp Diodes

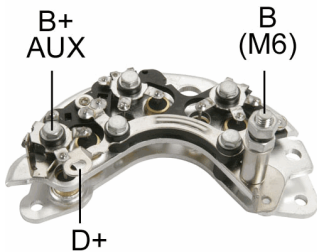

Replaces

LUCAS :

83569 83571 84765 UBB118 UBB126

MASSEY FERGUSON :

3475823M1

ROVER :

AEU1527 AEU1527J

Unit no.

LUCAS

23969	24010	24011	24046	24047	24055
24091	24093	24100	24125	24126	24127

RL-06H

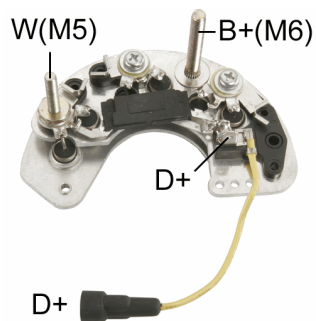

- *115mm OD
- *M6 Battery Post
- *6-35 Amp Diodes

Replaces

FORD :

864F-10304AA

LUCAS :

84456	84456010	84486	UBB140
-------	----------	-------	--------

Unit no.

LUCAS

24188	24213	24230	24264
-------	-------	-------	-------

RL-07H

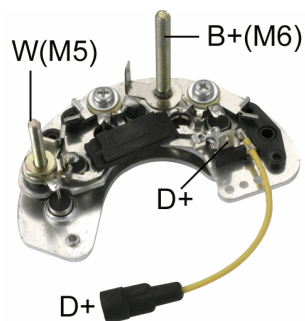

- *115mm OD
- *M6 Battery Post
- *6-35 Amp Diodes

Replaces

LUCAS :

84888	UBB147
-------	--------

Unit no.

LUCAS

24255	24287
-------	-------

RL-08HV

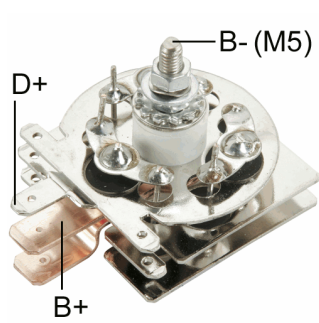

*115mm OD
*9-35 Amp Diodes

Replaces

BL/JAGUAR :

37H6913 607688 90607688 JS486 UKC1662

FORD :

69EB-10304AA D4NN-10304A

LUCAS :

83166(4DS5) 83334(4DS8) 83520 83842(4DS7) 83844 84443
UBB109(4D45) UBB110(4DS7)

MASSEY FERGUSON :

1429443M1 1888323M1 1897094M1 3474574M1

TALBOT :

75061613

Unit no.

LUCAS

23589	23590	23591	23592	23593	23605
23606	23615	23616	23617	23618	23619
23620	23622	23623	23632	23646	23647
23648	23653	23654	23659	23673	23675
23677	23679	23682	23685	23691	23692
23694	23695	23699	23700	23701	23702
23703	23704	23705	23706	23707	23708
23709	23711	23712	23713	23714	23715
23716	23717	23718	23719	23721	23723
23724	23725	23726	23727	23728	23729
23730	23731	23734	23735	23736	23737
23738	23739	23740	23743	23751	23752
23753	23754	23755	23758	23759	23760
23761	23762	23765	23766	23767	23768
23769	23770	23771	23773	23774	23775
23777	23779	23781	23782	23794	23799
23800	23801	23802	23807	23808	23809
23810	23811	23813	23814	23819	23828
23830	23831	23837	23839	23840	23841
23842	23846	23847	23848	23850	23851
23852	23853	23854	23855	23856	23857
23860	23865	23871	23873	23878	23879
23880	23888	23889	23891	23893	23896
23903	23904	23905	23906	23909	23910
23911	23912	23913	23914	23915	23916
23917	23918	23919	23920	23921	23922
23923	23924	23925	23926	23927	23928
23929	23943	23944	23945	23946	23947
23948	23949	23950	23962	23963	23989
23990	23991	23993	23994	24012	24014
24019	24022	24048	24103	24108	24123
24139					

RL-09H

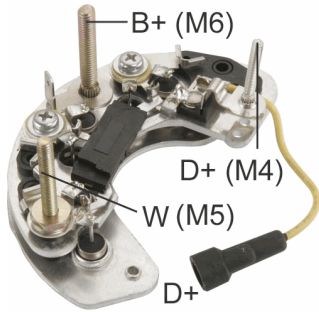

*115mm OD
*6-35 Amp Diodes

Replaces

FORD :

86AB-10304BA

LUCAS :

84469	UBB137	84469010	84886010	84469	84886
UBB137	80367	80150	84886		

MAGNETI MARELLI :

000000028502	000000084469	000000084886	000028502010	000084469010	28502
--------------	--------------	--------------	--------------	--------------	-------

ROVER :

LBU5225	RTC5371	RTC5671
---------	---------	---------

Unit no.

LUCAS					
24206AB	24207	24207A	24216	24217	24217A
24220	24220A	24221	24221A	54022159	LRA461
LRA517	LRA604				

RL-10H

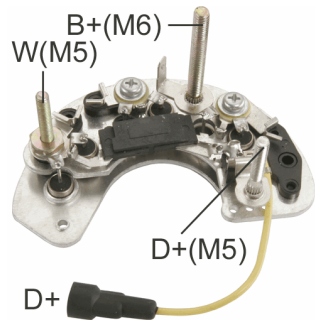

*115mm OD
*M6 Battery Post
*6-35 Amp Diodes

Replaces

LUCAS :

28500010	28506010	84976
----------	----------	-------

MAGNETI MARELLI :

63328506	28500	28506
----------	-------	-------

Unit no.

LUCAS
24286
NISSAN
23100-71J00

RL-11H

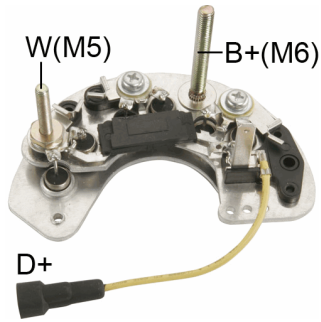

- *115mm OD
- *M6 Battery Post
- *6-35 Amp Diodes

Replaces

LUCAS :
84468 UBB136

Unit no.

LUCAS
24203 24214

RL-12H

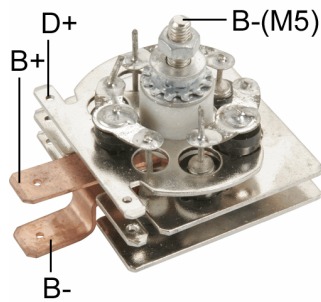

- *9-35 Amp Diodes

Replaces

BL/JAGUAR :
37H6924 606829

FORD :
692F-10304AA

LUCAS :
83062 83178 83192 84125 84460 UBB108
83962

TALBOT :
5059884

VAUXHALL :
2698242

Unit no.

LUCAS

23544	23548	23554	23555	23562	23563
23565	23566	23568	23570	23572	23573
23574	23575	23576	23581	23582	23583
23584	23585	23595	23597	23598	23599
23600	23602	23603	23624	23625	23626
23627	23629	23630	23631	23634	23635
23636	23637	23638	23639	23640	23641
23642	23643	23644	23645	23649	23650
23652	23653A	23655	23656	23658	23660
23661	23662	23663	23664	23665	23666
23667	23668	23676	23678	23696	23741
23742	23778	23780	23816	23820	23822
23823	23824	23825	23826	23827	23874
23890	23961				

RL-13

*9-25 Amp Diodes

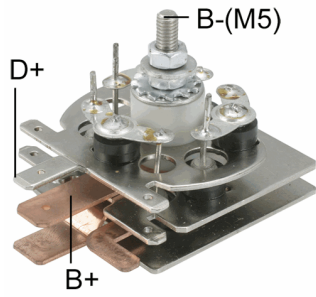

Replaces

BL/JAGUAR :

37H7965 RTC1004 UKC1657

LUCAS :

83295 84124 84459 UBB111

Unit no.

LUCAS

23745	23747	23748	23750	23793	23795
23796	23797	23804	23818	23843	23844
23845					

RL-13H

*M5 Battery Post
*9-35 Amp Diodes

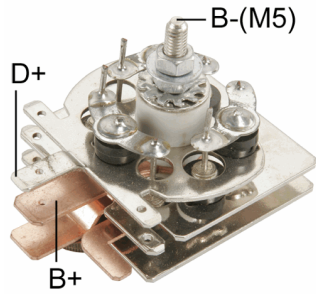

Replaces

BL/JAGUAR :

37H7965 RTC1004 UKC1657

LUCAS :

83295 84124 84459 UBB111

Unit no.

LUCAS

23745	23747	23748	23750	23793	23795
23796	23797	23804	23818	23843	23844
23845					

RL-14

*9-25 Amp Diodes

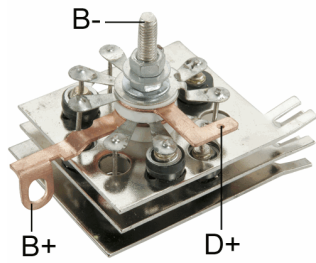

Replaces

LUCAS :

83442	83633	84718	UBB113
-------	-------	-------	--------

Unit no.

LUCAS

23835	23838	23859	23864	23868	23869
23876	23877	23881	23957	23958	23967
24017	24018	24029	24030	24032	24044
24045					

RL-14H

*9-35 Amp Diodes

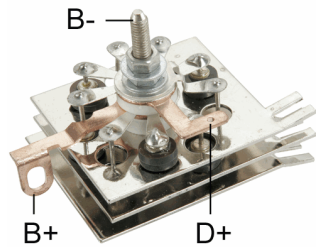

Replaces

LUCAS :

83442	83633	84718	UBB113
-------	-------	-------	--------

Unit no.

LUCAS

23835	23838	23859	23864	23868	23869
23876	23877	23881	23957	23958	23967
24017	24018	24029	24030	24032	24044
24045					

RL-15

*9-25 Amp Diodes

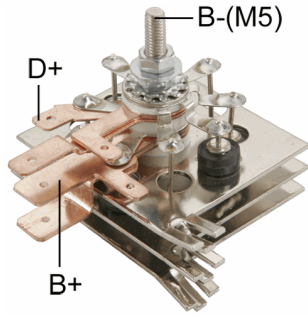

Replaces

BL/JAGUAR :

AAU8483 BAU1830

FORD :

75AB-10304AA

LUCAS :

83452 83634 84717 UBB130

MASSEY FERGUSON :

1895097M1

TALBOT :

35140800

VAUXHALL :

91062513 91103214

Unit no.

LUCAS

23833	23861	23862	23863	23867	23882
23883	23884	24031			

RL-15H

*M5 Battery Post
*9-35 Amp Diodes

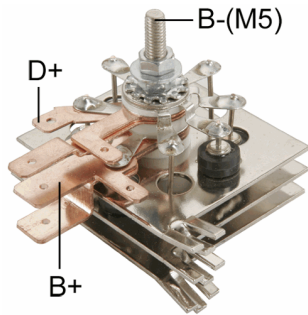

Replaces

BL/JAGUAR :

AAU8483 BAU1830

FORD :

75AB-10304AA

LUCAS :

83452 83634 84717 UBB130

MASSEY FERGUSON :

1895097M1

TALBOT :

35140800

VAUXHALL :

91062513 91103214

Unit no.

LUCAS

23833	23861	23862	23863	23867	23882
23883	23884	24031			

RL-16

*M5 Battery Post
*6-25 Amp Diodes

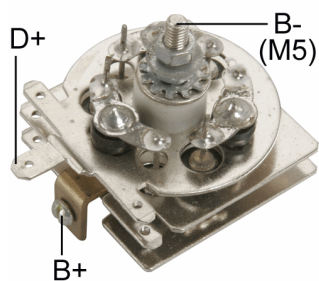

Replaces

FIAT :
9935804

LUCAS :
83584 84602 UBB128

Unit no.

FIAT
4423302
LUCAS
23980

RL-16H

*M5 Battery Post
*6-35 Amp Diodes

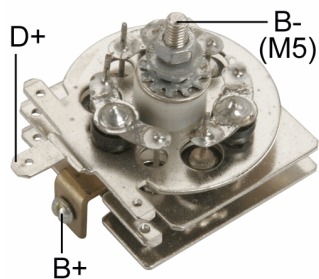

Replaces

FIAT :
9935804

LUCAS :
83610231010 83584 84602 UBB128

MAGNETI MARELLI :
83610231

Unit no.

FIAT
4423302
LUCAS
23980

RL-17H

- *122 mm OD
- *M6 Battery Post
- *6-35 Amp Diodes

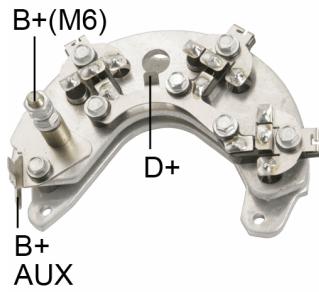

Replaces

LUCAS :

83763 UBB131

VALEO(DUCELLIER) :

593062

Unit no.

LUCAS

23970	23970AB	23971	23971A	24056	24056AB
24101	24101AE	24102	24102AE	24110A	24142
24142AB	24150AD	24150EF	24173	24173A	24176A
24186	24186AB	24201A	24250	24250A	24275A

RL-20H

- *9-35 Amp Diodes

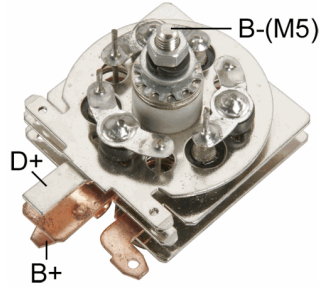

Replaces

LUCAS :

60211170 83320 UBB112

MAGNETI MARELLI :

940038261

Unit no.

LUCAS

23746	23746A	23756AD	23806	23806AB	23832AB
23849	23849A	23892A	LRA129		

RL-21H

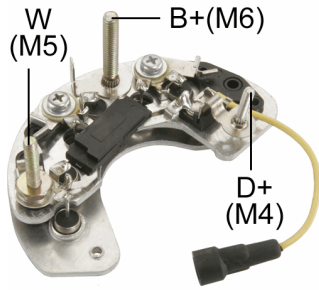

- *115mm OD
- *M6 Battery Post
- *6-35 Amp Diode

Replaces

FORD :
87BB-10304CA

LUCAS :
84572 UBB145 84572010

Unit no.

LUCAS					
24215	24215A	24216A	24224	24236	24257
24257A	24261A	24271	24271A	LRA516	LRA518
LRA521					

RL-22H

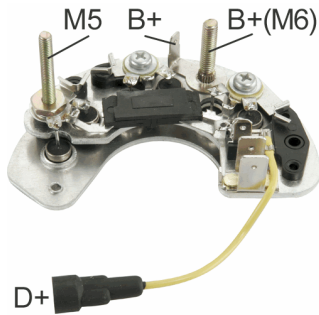

- *115mm OD
- *M5 Battery Post
- *6-35 Amp Diodes

Replaces

LUCAS :
84574 UBB138

NISSAN :
23230-Q9000

ROVER :
BAU5816

VALEO :
A559893A

Unit no.

LUCAS					
24223A	24235	24235AD	24322A	24356A	54022203
54022238	LRA775				

RL-23H

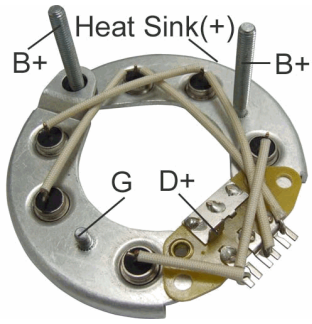

*6-35 Amp Diodes
*M6 Battery Post

Replaces

LUCAS :
35213274

Unit no.

LUCAS
35213725 35213730

RI-01H

*W/DIODE TRIO
 *6-35 Amp Button Diodes
 *Economy Version: RI-01HA

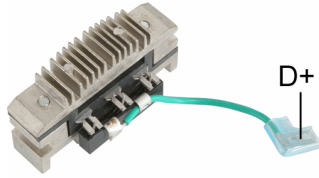

Replaces

FIAT :

9934595 9934958 9947325

MAGNETI MARELLI :

64826011 64826022 64826040 64877471 64878691 74877471
 74878691 PRD4A

Unit no.

FIAT

4379899 4393206 4395131 4419793 4715786 4738563

5920974

MAGNETI MARELLI

63300515	63300905	63300925	63305000	63305020	63305100
63305101	63305120	63305130	63305131	63305206	63305226
63305236	63305300	63305310	63305400	63305401	63305402
63305403	63305420	63305423	63305430	63305431	63305432
63305440	63305506	63305526	63305536	63305601	63305621
63305690	63305700	63305701	63305720	63305721	63305800
63305820	63305920	63306000	63306050	63306060	63306070
63306079	63306089	63306300	63306350	63306360	63306370
63306379	63306389	63306500	63306520	63306700	63306701
63306720	63306721				

RI-02

*W/DIODE TRIO
*6-25 Amp Diodes

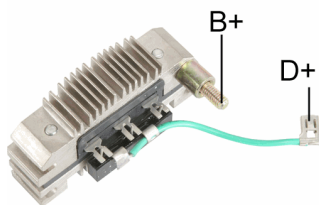

Replaces

DELCO REMY (LUCAS) :

21222124

FIAT :

9940293 79070381

LUCAS :

UBB812 UBB813 139587 63621503010 63621603010 63622601010
63623001010

MAGNETI MARELLI :

63621503 63621603 63623001 63621501 63621601 RDD15
RDD16 83621801

Unit no.

FIAT

4808510	4808513	4808517	4808518	5999868	5999869
7516759	7541401	7541822	7541823	7542145	7546342
7546343	7546660	7546686	7547660	7547686	7548004
7552284	7552382	7552458	7552675	7553788	7553853
7554830	7554832	7554833			

MAGNETI MARELLI

63320001	63320002	63320003	63320004	63320005	63320006
63320007	63320008	63320010	63320013	63320015	63320016
63320017	63320018	63320025	63320026	63320028	63321000
63321001	63321002	63321003	63321004	63321005	63321007
63321009	63321010	63321011	63321013	63321019	63321020
63321021	63321022	63321023	63321025	63321036	63321037
63321042	63321056	63321064	63321071		

RI-02H

*W/DIODE TRIO
 *6-35 Amp Diodes
 *Economy Version: RI-02HA

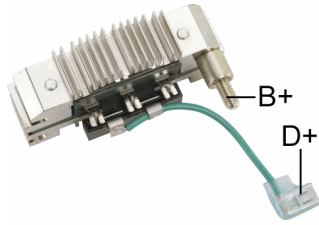

Replaces

DELCO REMY (LUCAS) :
 21222124

FIAT :
 9947325

MAGNETI MARELLI :
 63621501 63621601 RDD15 RDD16

Unit no.

FIAT

4808510	4808513	4808517	4808518	5999868	5999869
7541401	7541822	7541823	7542145	7546342	7546343
7546660	7546686	7546759	7547660	7547686	7548004
7552284	7552382	7552458	7552675	7553788	7553853
7554830	7554832	7554833			

MAGNETI MARELLI

63320001	63320002	63320003	63320004	63320005	63320006
63320007	63320008	63320010	63320013	63320015	63320016
63320017	63320018	63320025	63320026	63320028	63321000
63321001	63321002	63321003	63321004	63321005	63321007
63321009	63321010	63321011	63321013	63321019	63321020
63321021	63321022	63321023	63321025	63321036	63321037
63321042	63321056	63321064	63321071		

RI-03H



*6-35 Amp Diodes
*110mm OD

Replaces

FEMSA :

28466-16 28466-2 28466-7

FIAT :

4262908 4474847

LADA :

21013701314

MAGNETI MARELLI :

74965401 74965411 74967491 74992571

Unit no.

FEMSA

ALB4087	ALD1220	ALD1221	ALD1236	ALD1237	ALD1241
ALD1246	ALD1247	ALD1254	ALD1255	ALD1264	ALE1210
ALE1220	ALE1226	ALE1231	ALE2412	ALE2413	ALE2417
ALE2418	ALE2425	ALE2428	ALE2435	ALE2436	ALF1213
ALF1214	ALF1221	ALF1223	ALF1224	ALF123	ALF124
ALF126	ALG125	ALG127	AU24XM2		

LADA

22112642AAKM2 22114V50AAL35

MAGNETI MARELLI

63303001	63303041	63303061	63303120	63303130	63303140
63303150	63303191	63303502	63303700	63303701	63303702
63303720	63303721	63303722	63303731	63303780	63304002
63304003	63304040	63304050	63304075	63304079	63304081
63304082	63304083	63304084	63304087	63304090	63304100
63304120	63304221	63304222	63304231	63304800	63304830
63304840	63304870	63304880			

RI-04H

*6-35 Amp Diodes
*110mm OD



Replaces

FEMSA :
19326-1

FIAT :
4149607 4149609 4175054

MAGNETI MARELLI :
74953001 74990331 74990341 74999091

Unit no.

BOSCH

9-120-330-268 9-120-330-286

FEMSA

A124N A12M

FIAT

4181511 4378710 4380114 4408631 4474524 4474525

4474557 4474904 4475035 79014078

MAGNETI MARELLI

63301000 63301020 63303000 63303001 63303030 63303300

63304520

RI-05H

*6-35 Amp Diodes
*110mm OD



Replaces

BOSCH :
9-121-337-319

FEMSA :
25945-1

FIAT :
4474546

LUCAS :
21223056 21223062 UBB601

MAGNETI MARELLI :
74965501 74966611 74966621

TOSHIBA :
6M3

Unit no.

BOSCH

9-120-330-288 9-120-330-289

FEMSA

ALB40N88 ALB40N89

MAGNETI MARELLI

63303200 63303202 63303203 63303213 63303220 63303222

63303223 63303240 63303280 63303282 63303290 63303300

63303311 63303380 63303391 63304201

RI-06H

*6-35 Amp Diodes
*110mm OD

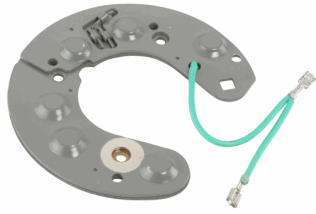

Replaces

BOSCH :

9-121-337-321	9-121-337-325	9-121-337-330	9-121-337-332	9-121-337-333	9-121-337-334
9-121-337-335					

FEMSA :

25945-10	25945-17	25945-20	25945-21	25945-25	25945-27
25945-3					

LUCAS :

UBB602

MAGNETI MARELLI :

940038237

PEUGEOT :

5722.98

Unit no.

BOSCH

9-120-331-853	9-120-331-854	9-120-331-863	9-120-331-872		
---------------	---------------	---------------	---------------	--	--

FEMSA

ALP12NR19	ALS12N53	ALS12N54	ALS12N63	ALS12N64	ALS12N72
-----------	----------	----------	----------	----------	----------

ALT12N38

RI-11H

*6-35 Amp Diodes
*M6 Battery Post

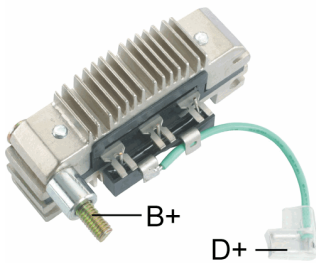

Replaces

MAGNETI MARELLI :

63622001

Unit no.

MAGNETI MARELLI

63320042	63320046	63321083	63321084	63321096
----------	----------	----------	----------	----------

RI-12H

*6-35 Amp Diodes
*M6 Battery Post

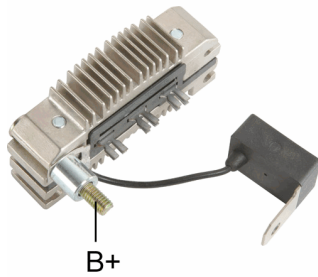

Replaces

MAGNETI MARELLI :

63022101 RDD346455

Unit no.

MAGNETI MARELLI

63322101 63620039

RI-13H

*6-35 Amp Diodes

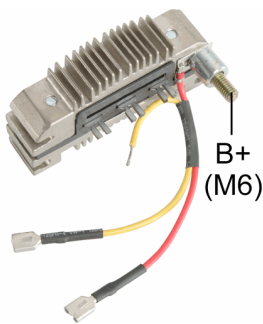

Replaces

MAGNETI MARELLI :

63622201 RDD22

Unit no.

MAGNETI MARELLI

63320041 63321083

RI-14H

*M8 Battery Post
*6-50A avalanche Diodes

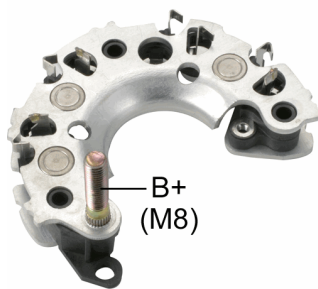

Replaces

MAGNETI MARELLI :

63633801 RDD33

Unit no.

MAGNETI MARELLI

63321204 63321233 63321234 63321252 63321287 63321330

63321601 63321612 63321618 63321629 63321631

RI-15H

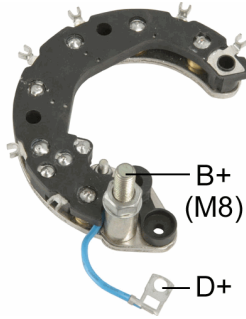

*M8 Battery Post
*6-35 Amp Diodes

Replaces

MAGNETI MARELLI :
5402243B

Unit no.

MAGNETI MARELLI

63320228	63320289	63320315	63321240	63321243	63321353
63441243					

RI-16H

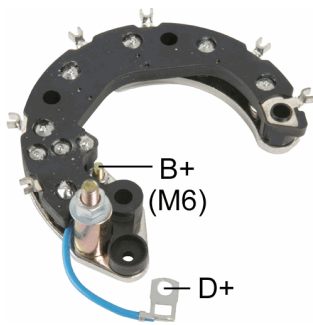

*M6 Battery Post
*6-35 Amp Diodes

Replaces

MAGNETI MARELLI :
00084574 54209741

Unit no.

MAGNETI MARELLI

54022437	54022459	54022469	54022470	54022510	54022536
54022591	54022606	54022646	54022647	54022651	54022656
63320312	63320313	63320314	63321358	63324320	63324380
63324390					

RI-17H

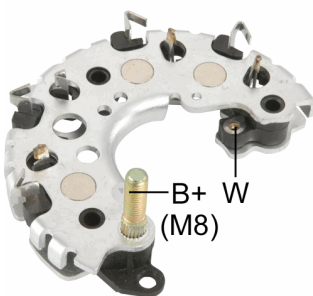

*M8 Battery Post
*6-50A Avalanche Diodes

Replaces

MAGNETI MARELLI :
63623601

Unit no.

MAGNETI MARELLI

63321353	63321354	63341353	63341354
----------	----------	----------	----------

RI-18H

*M6 Battery Post
*6-50A Avalanche Diodes

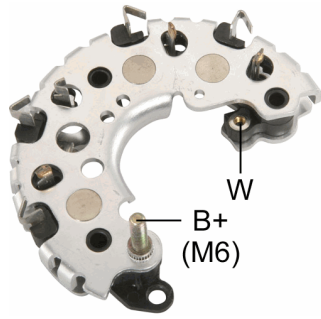

Replaces

MAGNETI MARELLI :
63623602

Unit no.

MAGNETI MARELLI

63320281	63320287	63320288	63320289	63320291	63321321
63321351	63321352	63341321	63341333	63341352	63341353

RI-19H

*M8 Battery Post
*8-50A Avalanche Diodes

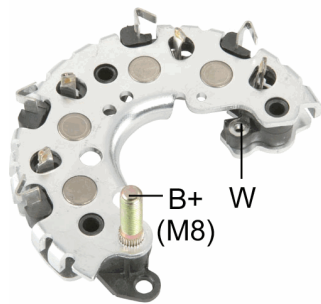

Replaces

MAGNETI MARELLI :
63623701

Unit no.

MAGNETI MARELLI

63321240

RI-20H

*M8 Battery Post
*6-50A Avalanche Diodes

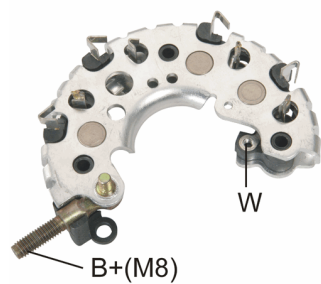

Replaces

MAGNETI MARELLI :
63624301

Unit no.

MAGNETI MARELLI

63320297	63321261	63341261
----------	----------	----------

RI-21H

*M8 Battery Post
*6-50A Avalanche Diodes

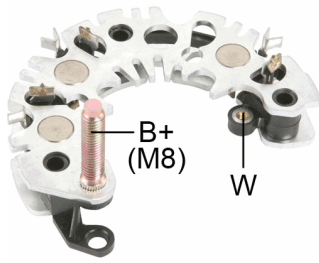

Replaces

MAGNETI MARELLI :

63623501	63624701	63624801	RDD35	RDD65	RDD75
----------	----------	----------	-------	-------	-------

Unit no.

MAGNETI MARELLI

63320204	63320227	63320238	63320253	63320257	63320258
63320259	63320261	63320263	63320264	63320265	63320500
63320502	63320503	63320504	63320505	63320506	63320508
63320510	63320511	63320512	63320515	63320519	63320520
63320522	63320530	63320531	63321204	63321205	63321206
63321207	63321208	63321209	63321210	63321211	63321213
63321215	63321235	63321270	63321275	63321276	63321277
63321278	63321280	63321281	63321282	63321283	63321300
63321311	63321361	63321362	63321367	63321396	63321600
63321602	63321603	63321616	63321617	63321620	63321625
63321626	63321632	63321640	63321660	63321661	

RI-22H

*M8 Battery Post
*8-50A Avalanche Diodes

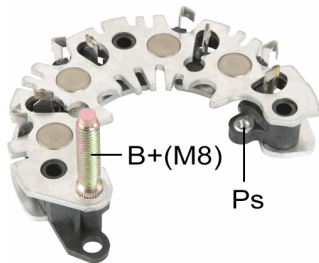

Replaces

MAGNETI MARELLI :

63623801

Unit no.

MAGNETI MARELLI

63320255	63320266	63320507	63320509	63320510	63320513
63320521					

RI-23H

*M8 Battery Post
*6-50A Avalanche Diodes

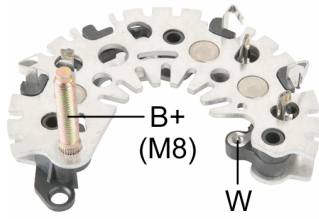

Replaces

MAGNETI MARELLI :
63624201

Unit no.

MAGNETI MARELLI

63320256	63320277	63320279	63320280	63320283	63320286
63320292	63320296	63320298	63320303	63320304	63320332
63320333	63320338	63320339	63320340	63320341	63320348

RI-23HD

*M8 Battery Post
*6-70A Avalanche Diodes
*Same as RI-23H but w/ 70 Amp diodes

Replaces

MAGNETI MARELLI :
63624201

Unit no.

MAGNETI MARELLI

63320256	63320277	63320279	63320280	63320283	63320286
63320292	63320296	63320298	63320303	63320304	63320332
63320333	63320338	63320339	63320340	63320341	63320348

RI-24H

*M6 Battery Post
*6-50A Avalanche Diodes

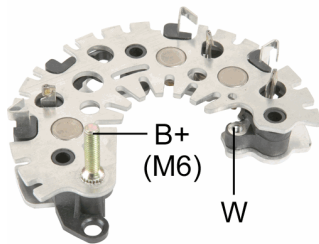

Replaces

MAGNETI MARELLI :
63624202

Unit no.

MAGNETI MARELLI

63320334	63320335	63320336
----------	----------	----------

RI-25

*M6 Battery Post
*6-50A Avalanche Diodes

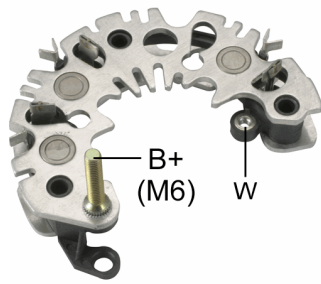

Replaces

MAGNETI MARELLI :
63624802 RDD75

Unit no.

MAGNETI MARELLI
63341238 63341239 63341666
VALEO(PARIS RHONE)
A115I

RI-26H

*8-50A Avalanche Diodes

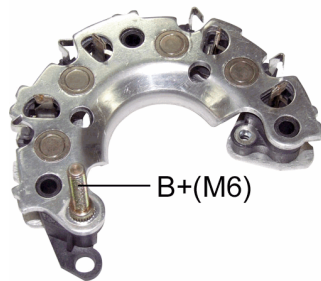

Replaces

MAGNETI MARELLI :
63321239

RI-31H

*107mm OD
*M6 Battery Post
*8-50A Avalanche Diodes

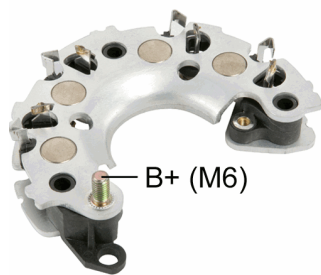

Replaces

MAGNETI MARELLI :
63624103 233534

Unit no.

MAGNETI MARELLI
A115I 63321348 63321356 63321692 63321693 63321704
63321705 63341704 63341705

RI-32H

*M6 Battery Post
*6-50A Avalanche Diodes

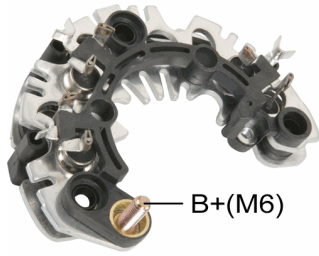

Unit no.

FORD

98AB-10300GC	98AB-10300GD	98AB-10300GE	98AB-10300GF	98AB-10300GG
MAGNETI MARELLI				
63321697	63341679	63341697	63321679	

RI-34

*6-50A Avalanche Diodes

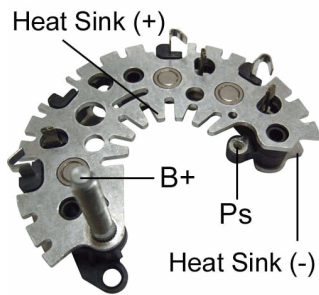

Unit no.

DENSO

102211-8641	102211-8650	102211-8661
-------------	-------------	-------------

RI-35

*M8 Battery Post
*6-50A Avalanche Diodes

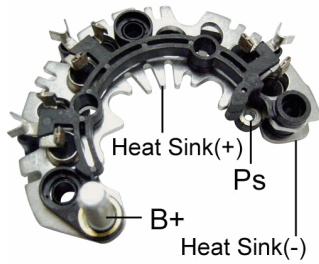

Replaces

MAGNETI MARELLI :

63625002	85552103	85552104	85552105	85552106	85552107
85552108	85552109	85552110			

Unit no.

MAGNETI MARELLI

63320500	63320502	63320510	63321287	63321292	63321330
63321601	63321604	63321605	63321606	63321607	63321608
63321612	63321615	63321616	63321617	63321744	A115I

RK-03

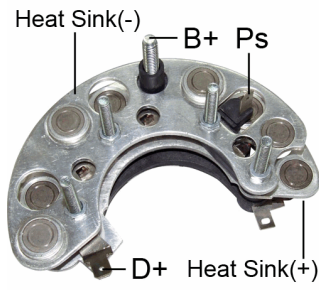

*8-50A Avalanche Diodes
*w/diode trio

Replaces

MAGNETON-PAL :

0135940 0135941 0140880 0140881 443930135940

RM-117

- *90mm Mtg. Length
- *M6 Battery Post
- *8-30 Amp diodes

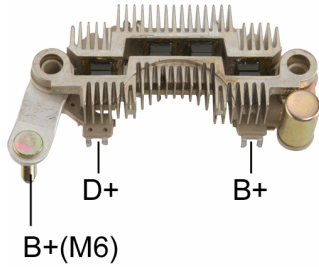

Unit no.

HYUNDAI
37300-22200

RM-118

- *90mm Mtg. Length
- *M6 Battery Post
- *6-30 Amp diodes

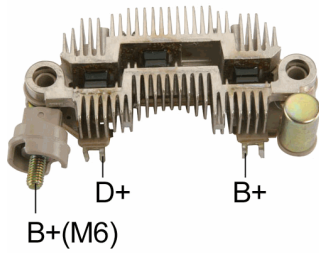

Unit no.

HYUNDAI
AB170094 OK2A2-18300

RM-123

- *108mm OD
- *6-35 Amp Diodes
- *w/diode trios



Replaces

VALEO :
136738 809162 811875 A600C0231 IMR5005

Unit no.

MANDO
A00B0431 AC15515 AC155515 AC155603 AC165610

RM-132

*M8 Battery Post
*6-50A Avalanche Diodes

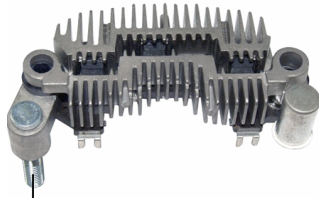

B+(M8)

Replaces

MANDO :
TA600C13301

Unit no.

MANDO
AB180128

RM-133

*90mm Mtg. Length
*M8 Battery Post
*8-30A Amp Diodes

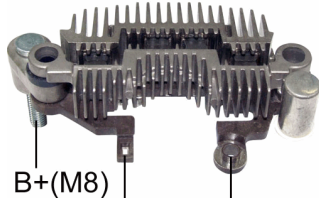

B+(M8)

D+

B+

Unit no.

HYUNDAI
37300-38310
MANDO
AB195126

RM-144

*M8 Battery Post
*8-30 Amp Diodes

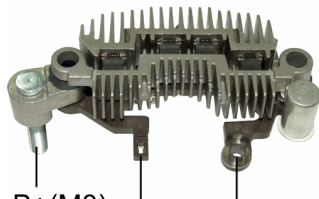

B+(M8)

D+

B+

Unit no.

MANDO
AB112112 AB112145

RM-198

*M6 Battery Post
*8-30 Amp Diodes

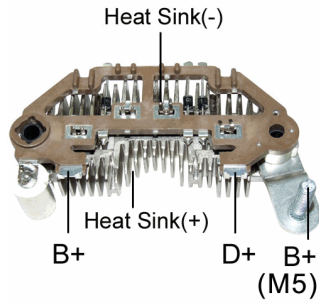

Unit no.

HYUNDAI
37300-22200
MANDO
AB190058

Used On

HYUNDAI

Accent 1.5L	1997-1999
Elantra 1.8L	1996-1998
Elantra 2.0L	1999-2000
Tiburon 1.8L	1997-1998
Tiburon 2.0L	1997-2001

RM-01HV

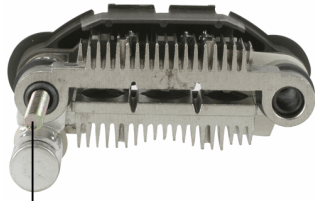

B+(M5)

- *65mm Mtg. Length
- *M5 Battery Post
- *O.E. Compatible Design with 6-50 Amp Diodes
- *RM-01 With Block Diodes

Replaces

MAZDA :

FE65-24-510	B101-18-W60	B603-18-W60	E356-18-W60	E356-18-W60A	F881-18-W60
FE65-24-510					

MITSUBISHI :

A860T21770	A860T27870	A860T11970	A860T13370		
------------	------------	------------	------------	--	--

MITSUBISHI MOTORS :

MD607828

Unit no.

FORD

E7GZ-10346A

MAZDA

B603-18-300	B603-18-300A	F356-18-300A	F651-18-300	FE85-18-300	N249-18-300B
N304-18-300	N304-18-300B				

MITSUBISHI

A1T40391	A1T40491	A5T30574	A5T30977	A5T31177	A5T40374
A5T41474					

MITSUBISHI MOTORS

MD069978	MD074992				
----------	----------	--	--	--	--

RM-02HV



B+(M5)

- *65mm Mtg. Length
- *M5 Battery Post
- *O.E. Compatible Design with 6-50A Diodes
- *RM-02 With Block Diodes

Replaces

FORD :

E7GY-10304A

MAZDA :

E356-18-W60	FE65-18-W60	FE65-18-W60A
-------------	-------------	--------------

MITSUBISHI :

A860T17470	A860T17870
------------	------------

Unit no.

MITSUBISHI

A5T16471	A5T30574	A5T30977	A5T31177	A5T41474
----------	----------	----------	----------	----------

RM-03HV

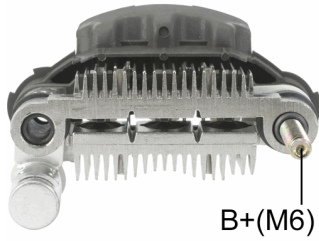

- *65mm Mtg. Length
- *M6 Battery Post
- *O.E. Compatible Design with 6-50A Diodes
- *RM-03 With Block Diodes

Replaces

MITSUBISHI :
A860T22770

SUBARU :
23830-KA070

Unit no.

MITSUBISHI

A1T02592

SUBARU

23700-KA190

23700-KA240

23700-KA360

RM-04HV

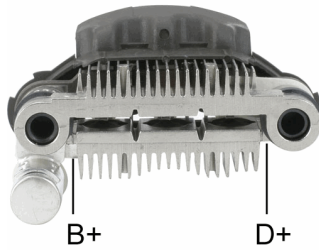

- *65mm Mtg. Length
- *O.E. Compatible Design with 6-50 Amp Diodes
- *RM-04 With Block Diodes

Replaces

MITSUBISHI :
A860T16770

MITSUBISHI MOTORS :
MD611254

Unit no.

HYUNDAI

37700-21030

37700-21320

MANDO

AR160A

MITSUBISHI

A1T01991

A1T40791

A1T40891

MITSUBISHI MOTORS

MD091849

MD091850

RM-05HV

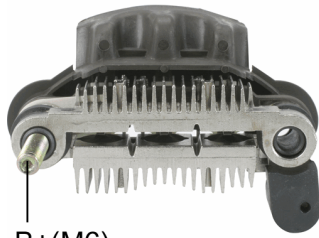

B+(M6)

- *65mm Mtg. Length
- *M6 Battery Post
- *O.E. Compatible Design with 6-50 Amp Diodes
- *RM-05 With Block Diodes

Replaces

MITSUBISHI :
A860T20570

NISSAN :
23124-53A10

Unit no.

MITSUBISHI

A5T41592 A5T41592B

NISSAN

23100-53A10 23100-53A11

RM-06

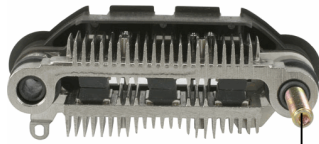

B+(M6)

- *75mm Mtg. Length
- *M6 Battery Post
- *6-30 Amp Diodes

Replaces

MITSUBISHI :
A860T13070 A860T13870 A860T17170

NISSAN :
23124-04F10 23124-05P10 23230-04F10

Unit no.

MITSUBISHI

A2T45272 A2T45272A A2T48176 A2T48195A A2T48195B

NISSAN

23100-04F01 23100-04F10 23100-04F11 23100-05P11 23100-15P11 23100-15P91

RM-07HV

- *75mm Mtg. Length
- *O.E. Compatible Design with 6-50 Amp Diodes
- *RM-07 With Block Diodes

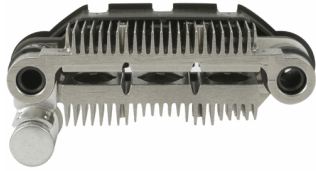

Replaces

MITSUBISHI :

A860T13170 A860T16970 A860T22570 A860T22670

MITSUBISHI MOTORS :

MD607917 MD611256 MD611688

Unit no.

MITSUBISHI

A2T00991	A2T02271	A2T02471	A2T03471	A2T03477	A2T03691
A2T03792	A2T03972	A2T41791	A2T41991	A2T42777	A2T43791
A2T43891	A2T43892	A2T48691	A2T48791	A2T49891	

MITSUBISHI MOTORS

MD073067	MD074644	MD082419	MD091793	MD091794	MD099624
MD099625	MD102085	MD102088	MD108230	MD108305	MD108509
MD109166	MD109741	MD110318	MD111151	MD111607	

RM-08HV

- *75mm Mtg. Length
- *M5 Battery Post
- *O.E. Compatible Design with 6-50 Amp Diodes
- *RM-08 With Block Diodes

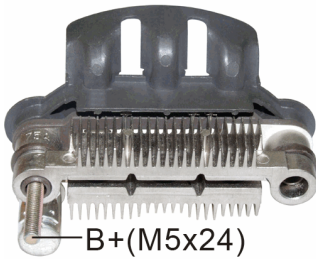

Replaces

FORD :

E98Z-10304A

MAZDA :

E5D3-18-W60A F811-18-W60 FE79-18-W60

MITSUBISHI :

A860T17570 A860T17970 A860T24270

Unit no.

MAZDA

B612-18-300A	B617-18-300	FE68-18-300C	HE19-18-300B	N225-18-300A	N245-18-300B
--------------	-------------	--------------	--------------	--------------	--------------

MITSUBISHI

A2T13471	A2T40374	A2T40377	A2T41674	A2T41677	A2T46871
----------	----------	----------	----------	----------	----------

RM-09HV

- *75mm Mtg. Length
- *O.E. Compatible Design with 6-50 Amp Diodes
- *RM-09 With Block Diodes



Replaces

MITSUBISHI :

A860T17270 A860T17285

NISSAN :

23124-08E16

Unit no.

MITSUBISHI

A2T46395 A2T46395B A2T48292 A2T48298

NISSAN

23100-26E10 23100-26E11 23100-26E60 23100-26E61 23100-D4110 23100-D4410
 23100-D4415

RM-100

- *85mm Mtg. Length
- *6-30 Amp diodes
- *O.E. Compatible

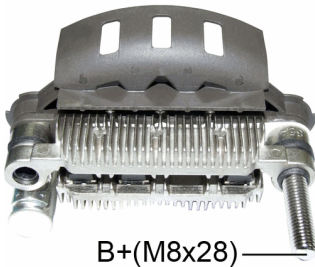

Unit no.

MITSUBISHI

A2T13391C A2T13391D A2T13391E

RM-105

- *71mm Mtg. Length
- *6-35 Amp Diodes

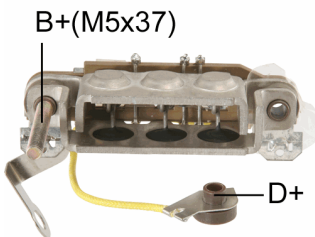

Replaces

MITSUBISHI :

A860T06470

Unit no.

MITSUBISHI

A1T70379

RM-10HV



B+(M6)

- *75mm Mtg. Length
- *M6 Battery Post
- *O.E. Compatible Design with 6-50 Amp Diodes
- *RM-10 With Block Diodes

Replaces

FORD :

E8GY-10304B E92Z-10304A

MAZDA :

B675-18-W60 F8B1-18-W60

MITSUBISHI :

A860T27170

Unit no.

FORD

E8GY-10346C E8GY-10346D E92Z-10346A

MANDO

AB175015 AB175019

MAZDA

B675-18-300A B675-18-300B F202-18-300 F225-18-300 F262-18-300 F881-18-300A

F88B-18-300B F8B1-18-300A

MITSUBISHI

A2T05772 A2T05892 A2T05893 A2T09493

RM-11



- *75mm Mtg. Length
- *6-30 Amp Diodes

Replaces

MITSUBISHI :

A860T17770

MITSUBISHI MOTORS :

MD611307

Unit no.

FORD

E8GY-10346B

MAZDA

B655-18-300A

MITSUBISHI

A2T03072 A2T03892 A2T09792 A2T13571 A2T49972 A2T49977

MITSUBISHI MOTORS

MD106508 MD106713 MD108305 MD117156 MD125569

RM-110HV

- *85mm Mtg. Length
- *M8 Battery Post
- *O.E. Compatible Design with 6-50 Amp Diodes

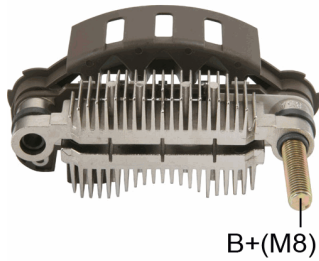

Replaces

MITSUBISHI :
A860T57870

Unit no.

MAZDA
Z599-18-300A
MITSUBISHI
A2TB0091

RM-112HV

- *85mm Mtg. Length
- *M5 Battery Post
- *O.E. Compatible Design with 6-50 Amp Avalanche Diodes

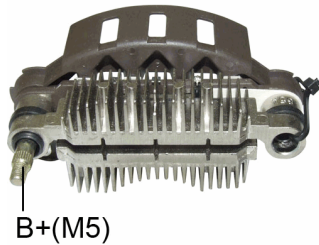

Unit no.

MITSUBISHI
A2TG4891A

RM-115

- *85mm Mtg. Length
- *M5 Battery Post
- *8-30 Amp Diodes

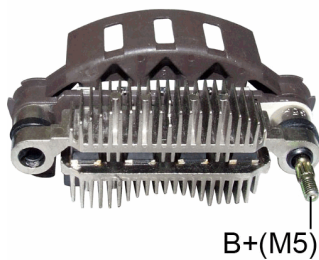

Unit no.

MITSUBISHI
A2TB6291

RM-116

- *100mm Mtg. Length
- *6-30 Amp Diodes
- *M8 Battery Post
- *O.E. Compatible



B+(M8x28)

Replaces

MITSUBISHI :
A860X47070

MITSUBISHI MOTORS :
ME701716

Unit no.

MITSUBISHI

A3T08699

A3T08799

A3T09698

A3T09699

A3T09799

A3TA3098

A3TA8199

RM-119H

- *M6 Battery Post
- *8-35 Amp diodes
- ** For Iran Market Only **



B+(M6)

Replaces

KIA :
KK137-24-W60

RM-12

B+(M5)

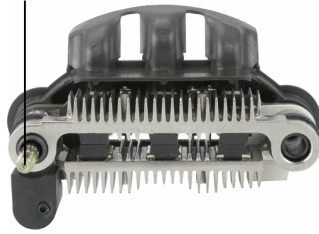

- *75mm Mtg. Length
- *M5 Battery Post
- *6-30 Amp Diodes

Replaces

MITSUBISHI :
A860T20270

NISSAN :
23124-58L10

Unit no.

FORD

E7GZ-10346A E804-10346B E8GY-10346B

HYUNDAI

37900-21030

MAZDA

B601-18-300 B603-18-300 B655-18-300 B665-18-300

MITSUBISHI

86651830 A2T02394 A2T02394B A2T13571 A2T48472

NISSAN

23100-07F11 23100-12C10 23100-12C11

RM-120

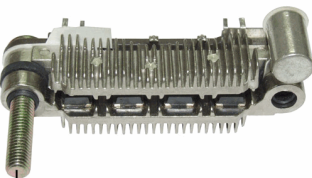

B+(M8)

- *85mm Mtg. Length
- *M8 Battery Post
- *W/D+ Terminal, W/Phase Terminal
- *8-30 Amp Diodes

Unit no.

MITSUBISHI

A4T40286 A4T40289 A4T40386 A4TU3085 A4TU3186

MITSUBISHI MOTORS

ME011886 ME077788 ME077789 ME092899 ME093245 ME151974

RM-124

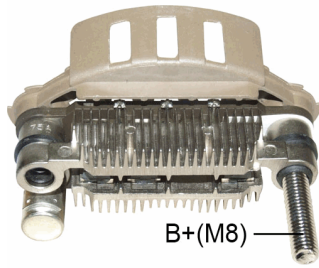

- *75mm Mtg. Length
- *M8 Battery Post
- *6-30 Amp diodes
- *O.E. Compatible

Replaces

MITSUBISHI :

A860T46570 A860X46570

MITSUBISHI MOTORS :

MD618844

Unit no.

HYUNDAI

37300-02503

MANDO

AB160108

MITSUBISHI

A1T06391

A1T06672

A1TA0091

A1TA0291

A1TA0491

A1TA0791

A1TA0891

MITSUBISHI MOTORS

MD300720

MD305885

MD311138

MD311711

MD311712

MD317530

MD317531

RM-125HV

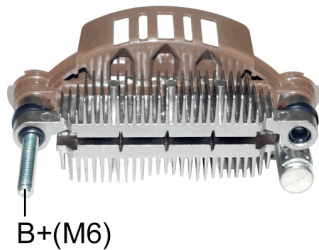

- *100mm Mtg. Length
- *M6 Battery Post
- *O.E. Compatible Design with 8-50 Amp Diodes

Unit no.

CHRYSLER

4609075

RM-126

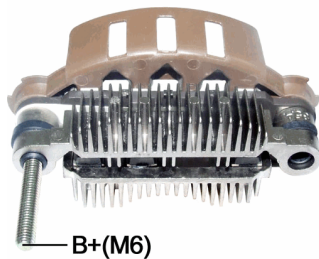

- *85mm Mtg. Length
- *M6 Battery Post
- *6-30 Amp diodes
- *O.E. Compatible

Unit no.

MITSUBISHI

A2TB1491

A2TB1941ZC

RM-127

- *100mm Mtg. Length
- *M6 Battery Post
- *8-30 Amp diodes
- *O.E. Compatible



B+(M6)

Replaces

MITSUBISHI :
A860X79470

Unit no.

MAZDA
 GY011-8300E GY011-8300R GY011-8W9XA
 MITSUBISHI
 A3TG2681 A3TB1081

RM-128

- *85mm Mtg. Length
- *M8 Battery Post
- *8-30 Amp diodes
- *O.E. Compatible

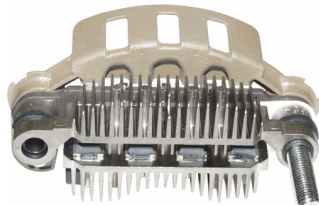

B+(M8)

Unit no.

MITSUBISHI
 A2TA5391 A2TB5791
 MITSUBISHI MOTORS
 MD317862

RM-129

- *75mm Mtg. Length
- *M5 Battery Post
- *6-30 Amp diodes

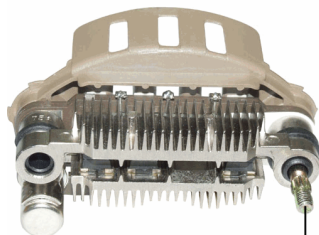

B+(M5)

Replaces

MITSUBISHI :
230261

Unit no.

HONDA
 31100-P2EA01 31100-P2EA02 31100-PEJ004
 MITSUBISHI
 A5TA0091 A5TA0991ZC A5TA4591

RM-129A

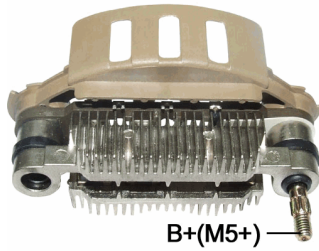

- *75mm Mtg. Length
- *M5 Battery Post
- *6-30 Amp diodes
- *w/o Trio
- *w/o Capacitor

Replaces

MITSUBISHI :
A860X70970

Unit no.

MITSUBISHI
A5TA3891 A5TA3891A
SUZUKI
31400-66D00 31400-66D01

RM-130

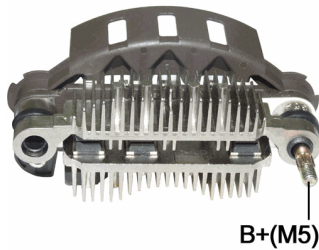

- *85mm Mtg. Length
- *M8 Battery Post
- *6-30 Amp Diodes

Replaces

MITSUBISHI :
A860X61970
SUBARU :
23830-AA130

Unit no.

MITSUBISHI
A2TA7691
SUBARU
23700-AA290

RM-131HV

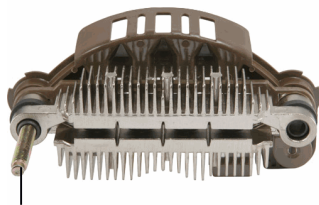

- *100mm Mtg. Length
- *M6 Battery Post
- *O.E. Compatible Design with 8-50A Diodes
- *RM-131 With Block Diodes

Unit no.

CHRYSLER
4606075 4609300
MITSUBISHI
A3T14292 A3TA4191 A3TA4191ZC

RM-134

- *100mm Mtg. Length
- *M8 Battery Post
- *8-30 Amp diodes
- *O.E. Compatible

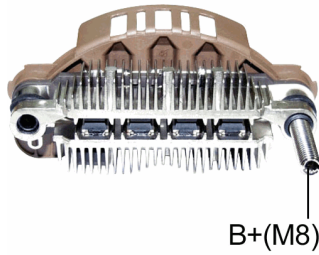

Unit no.

FORD

XF52-10300AC XF5Z-10346AA

MITSUBISHI

A3TA5691 A3TA5691ZC

NISSAN

23100-7B000

RM-135

- *85mm Mtg. Length
- *M6 Battery Post
- *6-30 Amp diodes
- *w/o diode trios
- *O.E. Compatible

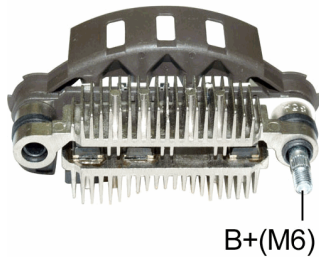

Unit no.

MITSUBISHI

A2TB2991

RM-136

- *75mm Mtg. Length
- *M6 Battery Post
- *8-30 Amp Diodes

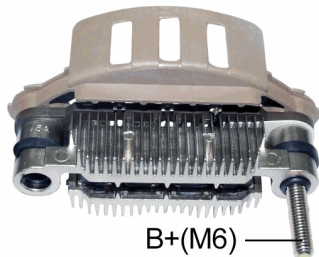

Replaces

MITSUBISHI :
A860X83370

Unit no.

HONDA

31100-PLM-A01 31100-PLM-A012 31100-PLM-C012

MITSUBA

A5TA7091 A5TA7191

RM-137HV



B+(M8x28)

- *100mm Mtg. Length
- *M8 Battery Post
- *O.E. Compatible Design with 8-50A Diodes
- *RM-137 With Block Diodes

Unit no.

MITSUBISHI
A4TA0092C

RM-139



B+(M8)

- *100mm Mtg. Length
- *6-30 Amp Diodes
- *M8 Battery Post
- *O.E. Compatible

Unit no.

MITSUBISHI
A3TB3491
MITSUBISHI MOTORS
MD373093

RM-14



B+(M6)

- *75mm Mtg. Length
- *M6 Battery Post
- *8-30 Amp Diodes
- *O.E. Compatible

Replaces

MITSUBISHI :
A860T27270

NISSAN :
23124-77A10

Unit no.

MITSUBISHI
A5T00192
NISSAN
23100-77A10

RM-143

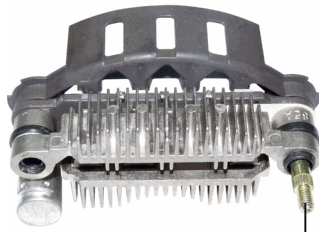

B+(M5)

- *85mm Mtg. Length
- *M5 Battery Post
- *6-50 Avalanche Diodes
- *O.E. Compatible

Unit no.

MITSUBISHI
A2TA1991F

RM-145

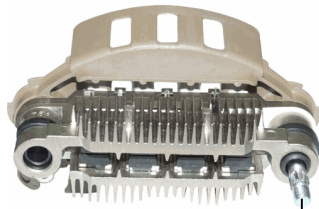

B+(M5)

- *75mm Mtg. Length
- *M5 Battery Post
- *8-30 Amp Diodes
- *O.E. Compatible

Unit no.

GM
30020754
MITSUBISHI
A5TA2491 A5TA2491ZC A5TA4291 A5TA4291ZC

RM-146



B+(M8)

- *100mm Mtg. Length
- *8-30 Amp Diodes
- *M8 Battery Post
- *w/ diode trios
- *O.E. Compatible

Replaces

MITSUBISHI :
A860X61870

Unit no.

MITSUBISHI
A3TA4298

RM-147

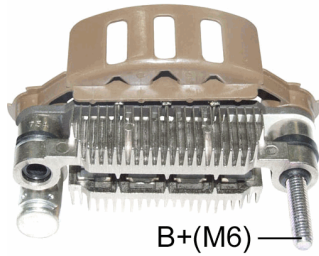

- *75mm Mtg. Length
- *M6 Battery Post
- *8-30 Amp diodes
- *w/ diode trios
- *O.E. Compatible

Replaces

MITSUBISHI :
A860T30370

Unit no.

MITSUBISHI
A001T03191 A001T04495

RM-15

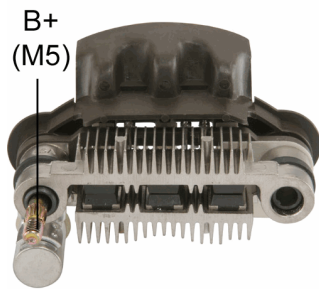

- *65mm Mtg. Length
- *M5 Battery Post
- *6-30 Amp Diodes
- *O.E. Compatible

Replaces

ECHLIN :
AC82

FORD :
E7GZ-10304A

HONDA :
31127-PE0-0340

LUCAS :
21513129 UBJ200

MAGNETI MARELLI :
940038255

MAZDA :
FE65-18-W60A FE65-24-510

MITSUBISHI :
A860T11970 A860T13370 A860T17470 A860T17870 A860T19870 A860X18371

MITSUBISHI MOTORS :
MD607828

Unit no.

MAZDA
B603-18-300A E356-18-300A F651-18-300 F873-18-300A FE65-18-300B FE85-18-300
N249-18-300B N304-18-300 N304-18-300B

MITSUBISHI
A1T40391 A5T30574 A5T30871 A5T30977 A5T31177 A5T31277
A5T31971 A5T31971A A5T40374 A5T41474 A5T41477 F65118300C
F87318300B FE6518300C

MITSUBISHI MOTORS
MD069978 MD074992

RM-151

*M8 Battery Post
*8-50A Avalanche Diodes



B+(M8)

Unit no. [Redacted]
VALEO
TA000A-48401 TA000A-48402

RM-152

*85mm Mtg. Length
*M8 Battery Post
*8-30 Amp Diodes
*O.E. Compatible

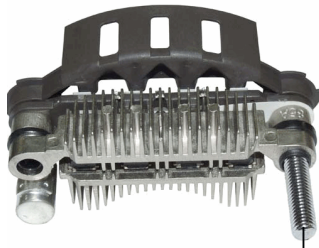

B+(M8)

Replaces [Redacted]
MITSUBISHI :
A860X49270
MITSUBISHI MOTORS :
MD618950

Unit no. [Redacted]
MITSUBISHI
A2TN0076 A2TN1199 A2TN1481 A2TN1798 A2TN2476

RM-153

*85mm Mtg. Length
*M6 Battery Post
*8-30 Amp diodes
*O.E. Compatible



B+(M6) B+

Unit no. [Redacted]
MITSUBISHI
A2TG0191 A2TG0191ZC

RM-157H

- *100mm Mtg. Length
- *M8 Battery Post
- *O.E. Compatible Design with 8-35A Diodes

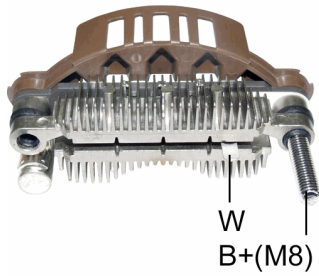

Replaces

MITSUBISHI :
A860X52670

MITSUBISHI MOTORS :
ME701570

RM-158H

- *75mm Mtg. Length
- *M6 Battery Post
- *O.E. Compatible Design with 6-35A Diodes

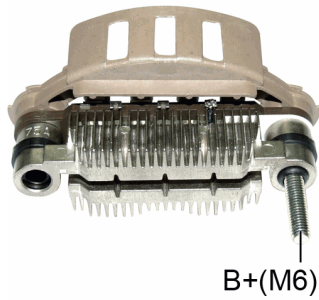

Unit no.

HONDA
31100-RSH-004
MITSUBISHI
A5TB1391

RM-159

- *85mm Mtg. Length
- *M8 Battery Post
- *8-30 Amp Diodes

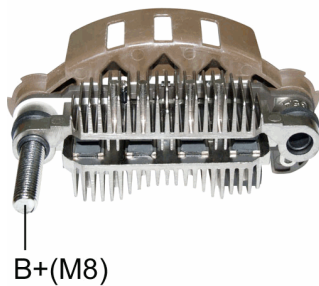

Unit no.

MITSUBISHI
A2TG0281
NISSAN
23100-DC000

RM-16

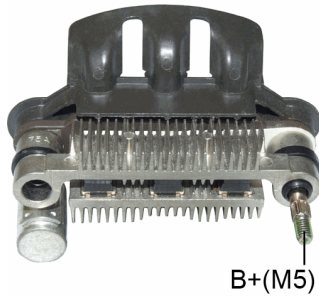

- *75mm Mtg. Length
- *M5 Battery Post
- *6-30 Amp Diodes
- *O.E. Compatible

Replaces

MITSUBISHI :
A860T27070

Unit no.

MAZDA
B675-18-300C
MITSUBISHI
A2T05772

RM-161HV

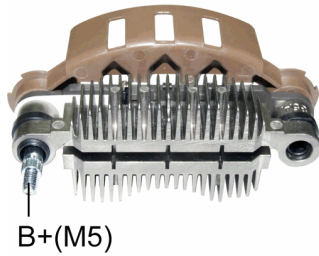

- *85mm Mtg. Length
- *M5 Battery Post
- *O.E. Compatible Design with 6-50A Diodes

Unit no.

MITSUBISHI
A2TG-1081ZT
NISSAN
23100-EB71A

RM-165H

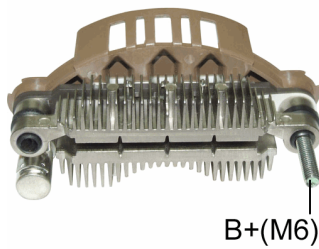

- *100mm Mtg. Length
- *M6 Battery Post
- *O.E. Compatible Design with 8-50A Diodes

Unit no.

MITSUBISHI
A3T04999 A3T06099
MITSUBISHI MOTORS
MD135825 MD147246

RM-166

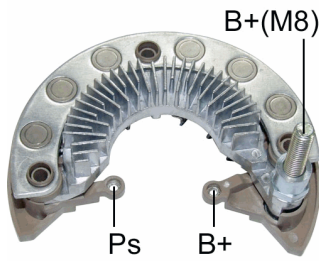

Heat Sink(+) Bottom

- *128mm OD
- *M8 Battery Post
- *12-50A Avalanche Diodes

Unit no.

NISSAN
23100-JD71A 23100-JG71A

RM-168

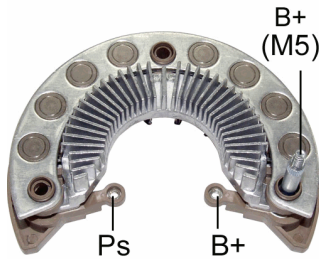

Heat Sink(+) Bottom

- *128mm OD
- *M5 x 0.8 Battery Post Term, Knurled
- *16-35A Avalanche Diodes

Unit no.

MITSUBISHI
A3TJ0781
NISSAN
23100-EB315

Used On

NISSAN

Pathfinder 2500	2005-2010
Navarra 2500	2005-2010

RM-169HV

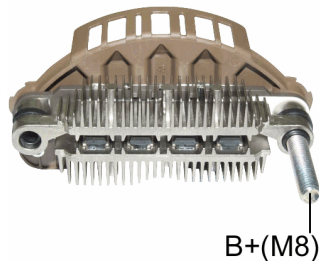

B+(M8)

- *100mm Mtg. Length
- *M8 Battery Post
- *O.E. Compatible Design with 8-50A Diodes

Unit no.

MITSUBISHI
A004TA8191 A4TA8191

RM-170

- *100mm Mtg. Length
- *M8 Battery Post
- *8-50 Amp Diodes

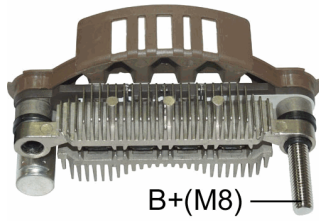

Replaces

MITSUBISHI :
A860X52570

MITSUBISHI MOTORS :
ME701569

Unit no.

MITSUBISHI
A3T75883 A3TN5188

RM-170HV

- *100mm Mtg. Length
- *M8 Battery Post
- *O.E. Compatible Design with 8-50 Amp Diodes

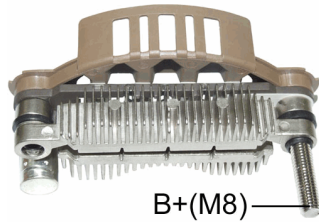

Replaces

MITSUBISHI :
A860X52570 A866X52570

MITSUBISHI MOTORS :
ME701569

Unit no.

MITSUBISHI
A3T75883 A3TN5188

RM-175

- *115mm OD
- *M6 Battery Post
- *12-50A Amp Diodes

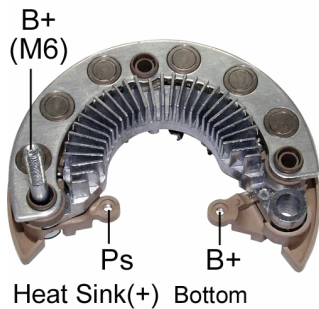

Unit no.

MITSUBISHI
A5TJ0091

Used On

HONDA
Fit 1.5L

2009-

RM-176

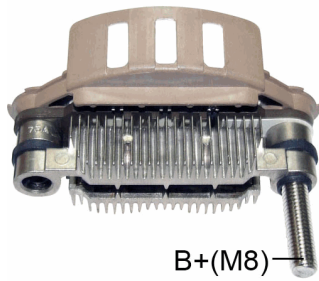

- *75 mm Mtg. Length
- *M8 Battery Post
- *8-30 Amp Diodes
- *O.E. Compatible

Unit no.

MITSUBISHI
A5TG0091

RM-178HD

Heat Sink(-) Top

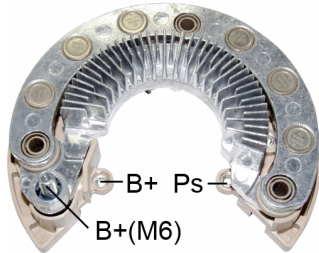

- *122mm OD
- *M6 Battery Post
- *12-50A Avalanche Diodes

Heat Sink(+) Bottom

Unit no.

FORD
8S4T-10300AA 8S4Z-10346A

Used On

FORD

Escape 2.5L	2009 -
Focus 2.0L	2008-2010
Focus 2.3L	2008-2010

RM-179

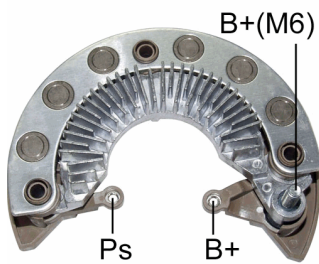

- *130mm OD
- *M6 Battery Post
- *12-50A Avalanche Diodes

Heat Sink(+) Bottom

Replaces

MITSUBISHI :
94675-C1323-7920H

Unit no.

MITSUBISHI
A3TJ1791 A3TJ1791ZC
NISSAN
23100-JA11AR 23100-JA11A

RM-18

- *75mm Mtg. Length
- *M5 Battery Post
- *6-30 Amp Diodes

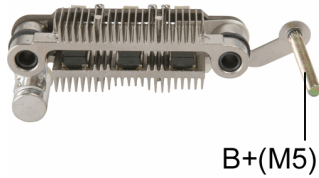

Replaces

MITSUBISHI :
A860T19370

MITSUBISHI MOTORS :
MD611501

Unit no.

MITSUBISHI				
A2T01077	A2T01976	A2T17783	A2T49577	
MITSUBISHI MOTORS				
MD099621	MD105606			

RM-180HV

- *122mm OD
- *M8 Battery Post
- *12-50 Amp Diodes

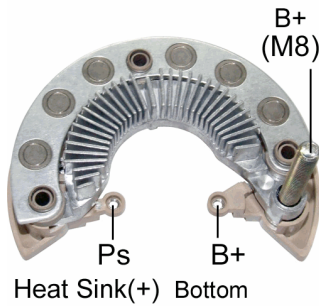

Unit no.

MITSUBISHI					
A2TJ0481	A2TJ0481ZC	A002TJ0281	A2TJ0281	A2TJ0281ZC	A2TJ0291
A2TJ0291ZC					
NISSAN					
23100-EM01A	23100-EM01B	23100-JD200	23100-JN81A		

RM-181

- *85mm Mtg. Length
- *M5 Battery Post
- *8-30 Amp diodes
- *O.E. Compatible

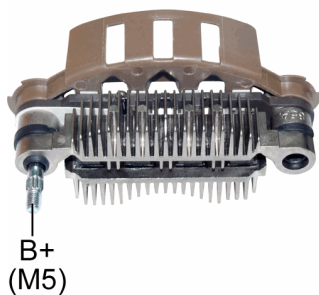

Unit no.

HONDA
31100-RNA-A01
MITSUBISHI
A2TC1391

RM-182

- *100mm Mtg. Length
- *M5 Battery Post
- *8-35 Amp diodes
- *O.E. Compatible

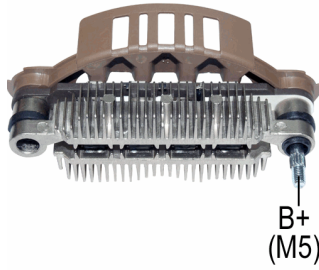

Unit no. [Redacted]

MAZDA
 LF1F-18-300
 MITSUBISHI
 A3TG2491 A3TG2491ZC A3TG4791

Used On [Redacted]

MITSUBISHI	
Eclipse 6 Cyl. 3.8L	2006-2010
Eclipse 6 Cyl. 3.8L	2011-2012
Galant 6 Cyl. 3.8L	2004-
Galant 6 Cyl. 3.8L	2005-2009
Endeavor 6 Cyl. 3.8L	2004-2008
Endeavor 6 Cyl. 3.8L	2010-2011

RM-183H

- *100mm Mtg. Length
- *8-50 Amp Diodes
- *M5 Battery Post

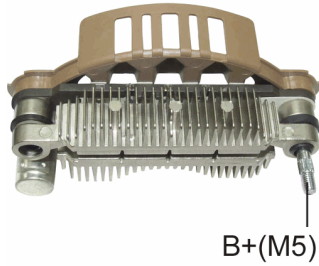

Unit no. [Redacted]

HYUNDAI
 37300-42354 37300-42356

Used On [Redacted]

HYUNDAI	
Satellite 2.5L	1997-
H1 2.5L TDSL	1997-
Starex 2.5L TDSL	1997-
MITSUBISHI	
L300	

RM-184

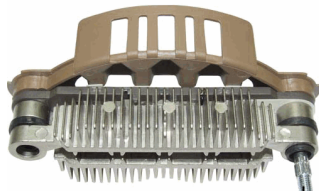

B+(M5)

- *100mm Mtg. Length
- *M5 Battery Post
- *6-30 Amp Diodes
- *O.E. Compatible

Unit no.

MITSUBISHI
A3TG2391
SUBARU
23700-AA55A

RM-185



B+(M5)

- *85mm Mtg. Length
- *M5 Battery Post
- *8-35 Amp Diodes
- *O.E. Compatible

Unit no.

MITSUBISHI
A2TB2891 A2TB2891ZC
SUBARU
23700-AA370 23700-AA37A

RM-187H

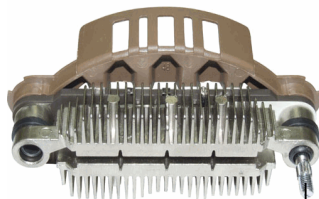

B+(M5)

- *100mm Mtg. Length
- *M5 Battery Post
- *8-35 Amp Diodes

Unit no.

FORD
2S6T-10300DB 2S6U-10300GB

RM-189H

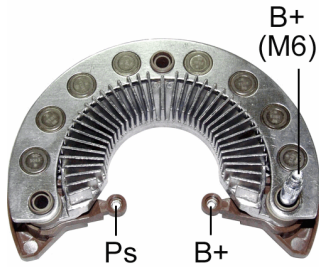

- *135mm OD
- *M6 Battery Post
- *16-50 Amp Diodes

Heat Sink(+) Bottom

Replaces

MITSUBISHI :
A860T88170

Unit no.

FORD
4W73-10300AC 4W7Z-10346AC FW73-10346AC
MITSUBISHI
A4TJ0181 A4TJ0181ZC

Used On

FORD
Crown Victoria 4.6L V8 2004-2006

RM-19

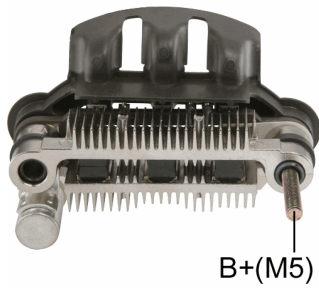

- *75mm Mtg. Length
- *M5 Battery Post
- *6-30 Amp Diodes

Replaces

MITSUBISHI :
A860T24570

Unit no.

MITSUBISHI
A2T03591 A2T03691 A2T03791 A2T03792
MITSUBISHI MOTORS
MD111151

RM-190HV

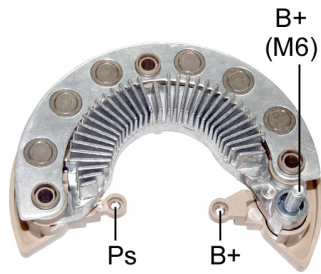

- *122mm OD
- *M6 Battery Post
- *12-50 Amp Diodes

Heat Sink(+) Bottom

Unit no.

MITSUBISHI
 A2TJ0391 A2TJ0391A A2TJ0391B A2TJ0391C

Used On

MAZDA

6 2.3L	2006-2008
6 2.5L	2009-
Miata 2.0L	2006-2008

RM-192

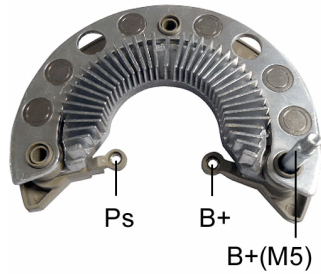

- *128mm OD
- *12-50 Amp Diodes
- *M5 Battery Post

Replaces

MITSUBISHI :
 A860X85670

Unit no.

MITSUBISHI
 A3TJ0191

Used On

MAZDA

MPV 3.0L	2002-2006
----------	-----------

RM-194

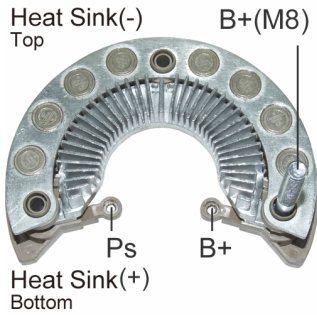

- *128mm OD
- *M8 Battery Post
- *16-35A Avalanche Diodes

Unit no. _____
 MITSUBISHI
 A3TJ0691
 NISSAN
 23100-EG010

Used On _____
NISSAN
 Navara 2.5L 2005-
 Pathfinder 2.5L 2005-

RM-195

- *100mm Mtg. Length
- *M5*38mm L Battery Post
- *8-40A Avalanche diodes (19-24V)

Replaces _____
MAZDA :
 N3H1-18-W60
MITSUBISHI :
 A860X66270

Unit no. _____
 MAZDA
 LF50-18-300A
 MITSUBISHI
 A3TG1391A

RM-199

Heat Sink(-)
Top

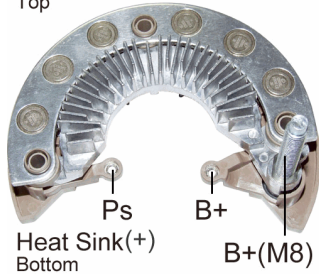

- *128mm OD
- *M8 Battery Post
- *12-50A Avalanche Diodes

Unit no.

CHRYSLER
4801477AA
MITSUBISHI
A3TJ2581

Used On

CHRYSLER

200 2.4L	2011-2012
Sebring 2.4L	2007-2010

DODGE

Avenger 2.4	2008-2010
Caliber 2.4L Turbo	2008-2009

JEEP

Compass 2.0L	2007-2010
Compass 2.4L	2007-2010
Patriot 2.0L	2007-2010
Patriot 2.4L	2007-2010

RM-200

- *135mm OD
- *M8 Battery Post
- *16-50A Avalanche Diodes

Unit no.

MITSUBISHI
A4TJ0282
RENAULT
8200654785

Used On

RENAULT

Laguna 2000	2007-2012
-------------	-----------

RM-203

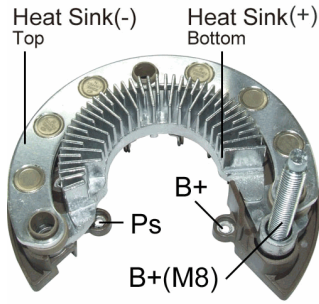

- *122mm OD
- *M8 Battery Post
- *12-50A Avalanche Diodes

Unit no.
 CHRYSLER
 04801490AA 4801490AA
 MITSUBISHI
 A2TX0281

Used On
DODGE
 Journey 2.4L 2009-2013

RM-205

- *100mm Mtg. Length
- *M8 Battery Post

Unit no.
 MITSUBISHI
 A3TR0188ZT

Used On
MITSUBISHI
 Canter 2007-

RM-208

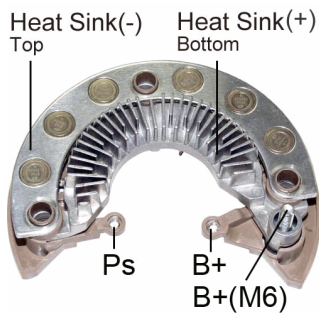

- *128mm OD
- *M6 Battery Post
- *12-50 Amp Diodes

Unit no.
 FORD
 6E5T-10300BA 6E5T-10300BD 6E5Z-10346BA 7E5T-10300BB
 MITSUBISHI
 A3TJ0991 A3TJ0991ZC

Used On
FORD
 Fusion V6 3.0L 2006-2009

RM-209

- *75mm Mtg. Length
- *M6 Battery Post
- *6-30 Amp diodes

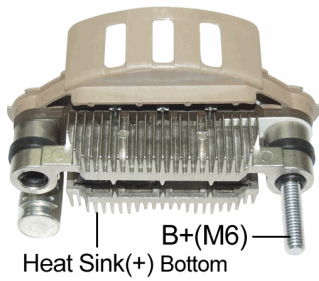

Unit no. _____
 MITSUBISHI
 A5T06591

Used On _____
PROTON
 416
 Wira

RM-20HV

- *75mm Mtg. Length
- *M6 Battery Post
- *O.E. Compatible Design with 6-50 Amp Diodes
- *RM-20 With Block Diodes

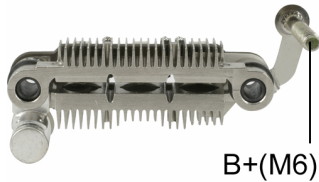

Replaces _____
MITSUBISHI :
 A860T22370 A860T22970 A860T25470 A860T32470
MITSUBISHI MOTORS :
 MD611479

Unit no. _____
 MITSUBISHI
 A2T01384 A2T01483 A2T01583 A2T01683 A2T01783 A2T02084
 MITSUBISHI MOTORS
 MD103372 MD103373 MD103564 MD106319 MD106320 MD106332

RM-21

- *75mm Mtg. Length
- *M6 Battery Post
- *6-30 Amp Diodes

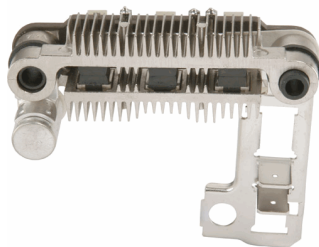

Unit no. _____
 MITSUBISHI
 A5T31772

RM-210HV

*100mm Mtg. Length
 *M8 Battery Post
 *8-35 Amp Diodes

Unit no.

MITSUBA		
A4TR5188	A4TR5191	A4TR5191ZT
RENAULT		
5001866377	5010480765	
SCANIA		
1516176	1525447	

RM-212

*128mm OD
 *M6 Battery Post
 *12-35 Amp Diodes

Unit no.

MITSUBISHI
 A3TJ3591
 SUBARU
 23700-AA620

Used On

SUBARU	
Legacy 6 Cyl. 3.6L	2010-2011
Tribeca 6 Cyl. 3.6L	2010-2011

RM-213

*128mm OD
 *M8 Battery Post
 *12-50A Avalanche Diodes

Unit no.

MITSUBISHI
 A3TJ2481
 NISSAN
 23100-JD71A

RM-22

*75mm Mtg. Length
 *M6 Battery Post
 *8-30 Amp Diodes

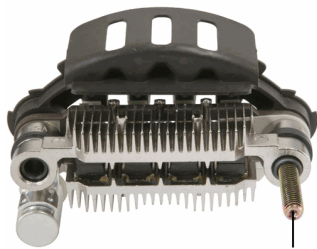

B+(M6)

Replaces

MAZDA :

B3C7-18-W60

MITSUBISHI :

A860T39770 A860T37070 A860X45670

NISSAN :

23124-OE711 23124-OE712

Unit no.

GM

96058486

MITSUBISHI

A1T03195 A5T07091

SUZUKI

31400-60A20

RM-23

*75mm Mtg. Length
 *M5 Battery Post
 *8-30 Amp Diodes

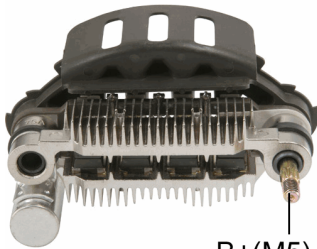

B+(M5)

Replaces

MAZDA :

B61P-18-W60 B64J-18-W60

MITSUBISHI :

A860T32570 A860T37770 A860T37870 A860X45281

Unit no.

MAZDA

BP02-18-300

MITSUBISHI

A5T00877 A5T01577 A5T01977 A5T02777 A5T03677 A5T03777

RM-24

*75mm Mtg. Length
*M5 Battery Post
*6-30 Amp Diodes



B+(M5)

Replaces

MITSUBISHI :
A860X20099

Unit no.

MITSUBISHI
A2T07577 A2T34794A A2T47794
NISSAN
23100-0H611

RM-27

*75mm Mtg. Length
*8-30 Amp Diodes

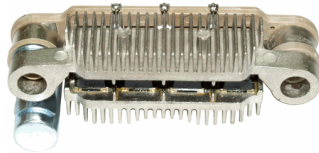

Replaces

MITSUBISHI :
A860T38570

Unit no.

HONDA
31100-P00-014
MITSUBISHI
A5T04292

RM-28

*75mm Mtg. Length
*M5 Battery Post
*8-30 Amp Diodes

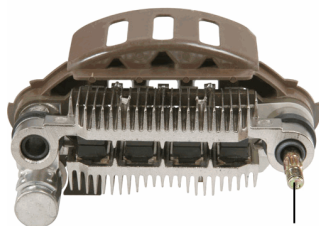

B+(M5)

Replaces

MITSUBISHI :
A866X45281

Unit no.

MITSUBISHI
A5T06391

RM-29HV

- *85mm Mtg. Length
- *O.E. Compatible Design with 6-50 Amp Diodes
- *RM-29 With Block Diodes



Replaces

FORD :
E8PZ-10301B

MITSUBISHI :
A860T28670

Unit no.

FORD	E83F-10300AA	E83F-10300AB	E83F-10300BA	E83Z-10346A
MITSUBISHI	A3T01596	A3T01598		

RM-30

- *85mm Mtg. Length
- *M6 Battery Post
- *6-30 Amp Diodes

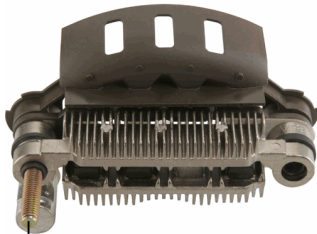

B+(M6)

Replaces

FORD :
E8PZ-10304A GYE1379

MITSUBISHI :
A860T28770

Unit no.

FORD	E8SF-10300AA	E8SF-10346A
MITSUBISHI	A3T01496	

RM-31

*85mm Mtg. Length
 *M6 Battery Post
 *6-30 Amp Diodes

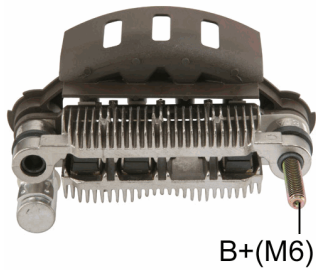

Replaces

MAZDA :

F825-18-W60 JE15-18-W60

MITSUBISHI :

A860T31370 A860T34070

Unit no.

MAZDA

F285-18-300C JE15-18-300A

MITSUBISHI

A2T13977 A2T19677 A2T19877 A2T19991 A2T20191 A2T32899
 A3T00792

RM-32

*85mm Mtg. Length
 *8-30 Amp Diodes

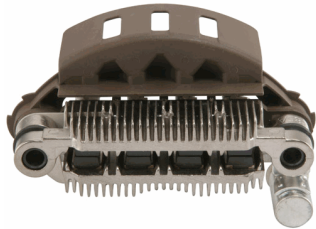

Replaces

FORD :

E9PZ-10304A

Unit no.

FORD

E9DF-10300BB F02U-10300AA F02Z-10346A

MITSUBISHI

A3T00491 A3T00896 A3T12691 A3T12792

RM-33

*85mm Mtg. Length
 *M5 Battery Post
 *8-30 Amp Diodes

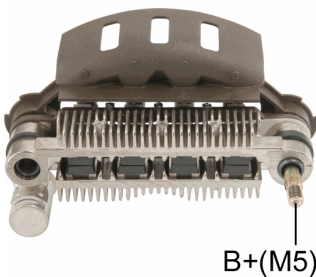

Unit no.

MITSUBISHI

A3T01691

SUBARU

23700-AA060

RM-34HV

B+(M6)

- *85mm Mtg. Length
- *M6 Battery Post
- *O.E. Compatible Design with 8-50 Amp Diodes
- *RM-34 With Block Diodes

Replaces

MITSUBISHI :
A860T23270

MITSUBISHI MOTORS :
MD611586

Unit no.

MITSUBISHI

A3T00692 A3T04292

MITSUBISHI MOTORS

MD112323

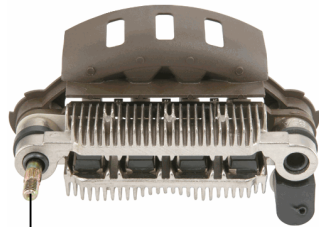
RM-35

B+(M5)

- *85mm Mtg. Length
- *M5 Battery Post
- *8-30 Amp Diodes

Replaces

MITSUBISHI :
A860T29970 A860T29999

Unit no.

MITSUBISHI

A2T14694 A2T18792

NISSAN

23100-35F10 23100-65E10

RM-36

- *85mm Mtg. Length
- *M6 Battery Post
- *6-30 Amp Diodes



B+(M6)

Replaces

MITSUBISHI :
A860T38770

MITSUBISHI MOTORS :
MD618568

Unit no.

MITSUBISHI

A2T34892	A2T34992	A2T35091	A2T35092	A2T36391	A2T36392
A2T38491	A2T38891	A2T38892	A2T40092		

MITSUBISHI MOTORS

MD175810	MD175811	MD177244	MD184278	MD184279	MD184280
MD184281	MD189658	MD189659	MD191402		

RM-37

- *85mm Mtg. Length
- *M8 Battery Post
- *6-30 Amp Diodes



B+(M8)

Unit no.

MITSUBISHI
A2T20091

RM-38

- *85mm Mtg. Length
- *M5 Battery Post
- *6-30 Amp Diodes

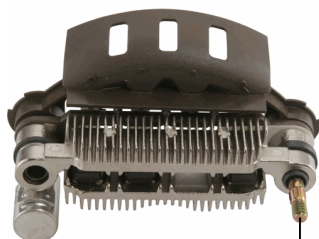

B+(M5)

Replaces

MITSUBISHI :
A860T38270

Unit no.

MITSUBISHI		
A2T17574	A2T18874	A2T34477

RM-39

- *85mm Mtg. Length
- *M5 Battery Post
- *6-30 Amp Diodes
- *O.E. Compatible

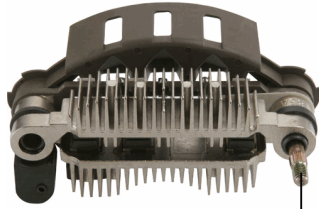

B+(M5x18)

Replaces

MAZDA :

B366-18-W60

MITSUBISHI :

A860T37670 A860T39170

Unit no.

MITSUBISHI

A2T33991 A2T35177

RM-40

- *100mm Mtg. Length
- *8-30 Amp Diodes

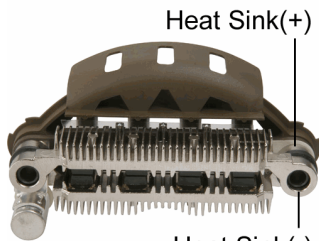

Heat Sink(+)

Heat Sink(-)

Replaces

MITSUBISHI :

A860T23070 A860T28070

MITSUBISHI MOTORS :

MD611564 MD611768

Unit no.

MITSUBISHI

A3T02192 A3T02193 A3T03391 A3T03392 A3T03393 A3T03493

A3T04493 A3T08293 A3T41876 A3T41892 A3T45694

MITSUBISHI MOTORS

MD111233 MD126110 MD133171 MD136838 MD136839 MD141855

MD158495 MD168989

RM-41

*100mm Mtg. Length
 *M6 Battery Post
 *8-30 Amp Diodes



B+(M6)

Replaces

FORD :
 E9PZ-10304B

MITSUBISHI :
 A860T35270

Unit no.

FORD
 E9SF-10300DA
 HYUNDAI
 AB175020
 MITSUBISHI
 A4T00796
 MOTORCRAFT
 GLE-265

RM-42

*100mm Mtg. Length
 *M5 Battery Post
 *8-30 Amp Diodes

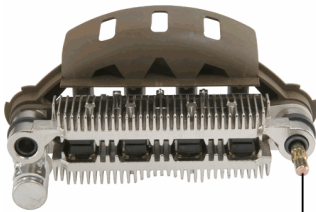

B+(M5)

Replaces

MITSUBISHI :
 A860T30170

SUBARU :
 23830-AA030

Unit no.

MITSUBISHI
 A3T03891
 SUBARU
 23700-AA061

RM-43

- *100mm Mtg. Length
- *M6 Battery Post
- *8-30 Amp Diodes
- *w/diode trios



B+(M6)

Replaces

FORD :

E9PZ10304B

MITSUBISHI :

MD611599

MD611742

A860T26070

137486

A600C10301

A860T23070

A860T23370

A860T28070

VALEO :

137486

Unit no.

MITSUBISHI

A4T01493

A4T01893

A4T03191

MITSUBISHI MOTORS

MD150657

MD197470

RM-44

- *100mm Mtg. Length
- *M6 Battery Post
- *8-30 Amp Diodes

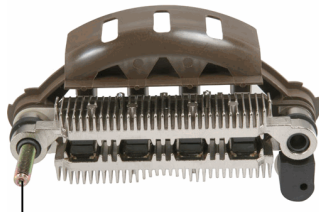

B+(M6)

Replaces

MITSUBISHI :

A860T31770

A860X31799

A860X34799

Unit no.

MITSUBISHI

A3T05192

RM-45

- *100mm Mtg. Length
- *M8 Battery Post
- *8-30 Amp Diodes

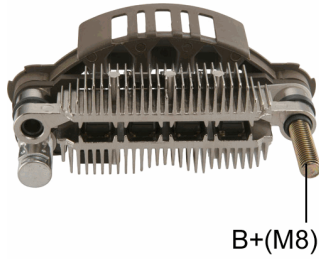

Replaces

MAZDA :

JE48-18-W60B

MITSUBISHI :

A860T36770

Unit no.

MAZDA

JE48-18-300

MITSUBISHI

A3T07592

RM-46

- *100mm Mtg. Length
- *M5 Battery Post
- *8-30 Amp Diodes

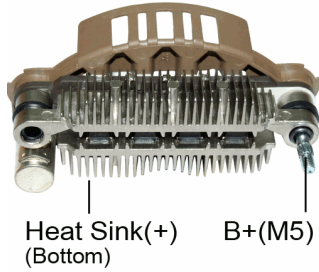

Replaces

MAZDA :

K801-18-W60 N3A1-18-W60 135902

MITSUBISHI :

A860T38670 A860T40270

Unit no.

MAZDA

K801-18-300C

MITSUBISHI

A3T08491 A3T08591

RM-47

- *100mm Mtg. Length
- *M6 Battery Post
- *8-30 Amp Diodes
- *O.E. Compatible

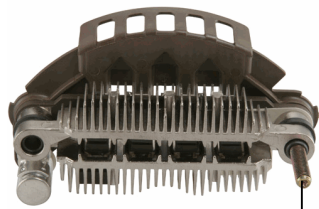

B+(M6)

Replaces

MITSUBISHI :
A860T42070

Unit no.

FORD
F3LU-10300BC
MITSUBISHI
A3T41591

RM-48

- *100mm Mtg. Length
- *M8 Battery Post
- *8-30 Amp Diodes

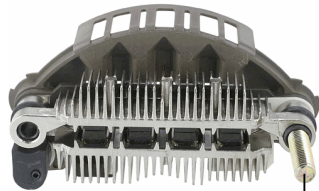

B+(M8)

Replaces

MITSUBISHI :
A860T33970

Unit no.

FORD
F3XA-10300AB F3XA-10300AC
MITSUBISHI
A4T02591
NISSAN
23100-0B000

RM-50HV

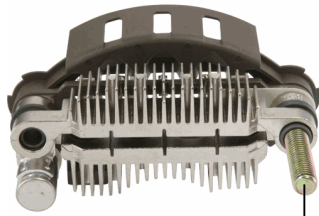

B+(M8)

- *85mm Mtg. Length
- *M8 Battery Post
- *O.E. Compatible Design with 6-50 Amp Diodes
- *RM-50 With Block Diodes

Replaces

MITSUBISHI :

A860T42670 A860T42770

MITSUBISHI MOTORS :

MD618734 MD618752

Unit no.

MITSUBISHI

A2T33891 A2T38391

MITSUBISHI MOTORS

MD190819 MD198164 MD306649

RM-53HV



B+(M6x32)

- *85mm Mtg. Length
- *M6 Battery Post
- *O.E. Compatible Design with 8-50 Amp Diodes
- *RM-53 With Block Diodes

Replaces

CHRYSLER :

138893

MITSUBISHI :

138893

Unit no.

CHRYSLER

4686106 4609101 4609125 4609320 4661998 4671041

4793189;

MITSUBISHI

A2TA7491 A2T81192 A2T81292 A2T81391

RM-54HV

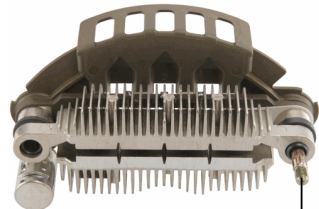

B+(M5)

- *100mm Mtg. Length
- *M5 Battery Post
- *O.E. Compatible Design with 8-50 Amp Diodes
- *RM-54 With Block Diodes

Unit no.

FORD

F3LY-10346A

RM-57

- *85mm Mtg. Length
- *M8 Battery Post
- *Same as RM-37 except RM-57 is 8-30 Amp Diodes



B+(M8)

Replaces

MITSUBISHI :
A860T32170

Unit no.

MITSUBISHI

A2T34991	A2T35092	A2T38891	A2T38892	A2T39891	A2T40092
A2T83291	A2TA3491				

MITSUBISHI MOTORS

MD175810	MD175811	MD177244	MD184278	MD184279	MD184280
MD184281	MD189658	MD189659	MD191402	MD193323	MD195437
MD309837	MD317401				

RM-58

- *85mm Mtg. Length
- *M5 Battery Post
- *Same as RM-39 except RM-58 is 8-30 Amp Diodes



B+(M5)

Replaces

MITSUBISHI :
A860T38970

Unit no.

MITSUBISHI

A2T33191

RM-59

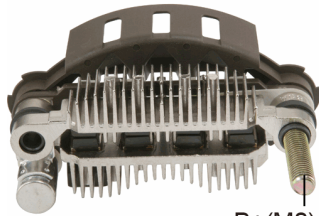

- *85mm Mtg. Length
- *Same as RM-50 except RM-59 is 8-30 Amp Diodes
- *M8 Battery Post
- *w/diode trios

Replaces

FORD :

F32Z-10304A

MAZDA :

FS11-18-W60

MITSUBISHI :

A860T39070 A860X44170

MITSUBISHI MOTORS :

MD618811

Unit no.

FORD

F32Z-10346A

MITSUBISHI

A2T33891	A2T38392	A2T80591	A2T82791	A2T82792	A2T82899
----------	----------	----------	----------	----------	----------

A2TA0991

MITSUBISHI MOTORS

MD194482	MD304129	MD306649	MD310997	MD313939	MD314235
----------	----------	----------	----------	----------	----------

MD314236	MD314374	MD315430	MD327535		
----------	----------	----------	----------	--	--

RM-59HV

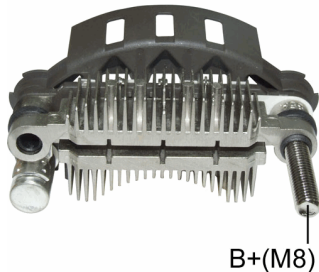

- *85mm Mtg. Length
- *Same as RM-50HV except RM-59HV is 8-50 Amp Diodes
- *M8 Battery Post
- *w/diode trios
- *O.E. Compatible Design

Replaces

FORD :

F32Z-10304A

MAZDA :

FS11-18-W60

MITSUBISHI :

A860X42770 A860T39070 A860X44170

MITSUBISHI MOTORS :

MD618811

Unit no.

FORD

F32Z-10346A

MITSUBISHI

A2T33891	A2T38392	A2T80591	A2T82791	A2T82792	A2T82899
----------	----------	----------	----------	----------	----------

A2TA0991

MITSUBISHI MOTORS

MD194482	MD304129	MD306649	MD310997	MD313939	MD314235
----------	----------	----------	----------	----------	----------

MD314236	MD314374	MD315430	MD327535		
----------	----------	----------	----------	--	--

RM-60

*71mm Mtg. Length
*6-35 Amp Diodes



Replaces

LUCAS :

21511124

MAZDA :

D401-24-510

MITSUBISHI :

A860T04370 A860T05070 A860T11070

MITSUBISHI MOTORS :

MD607429

NISSAN :

23124-B9810

Unit no.

MITSUBISHI

3066857101	3446826100	3446828100	A1T02871	A1T22771	A1T22971
A1T23283	A1T25077	A1T25083	A1T25477	A1T31377	A1T70783
A1T70883	A4T25172	A4T25199			

NISSAN

23100-01W10	23100-06T10	23100-B9810	34468-16100		
-------------	-------------	-------------	-------------	--	--

RM-61

*71mm Mtg. Length
*6-35 Amp Diodes

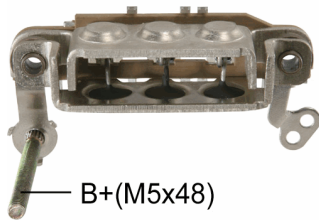

Replaces

MITSUBISHI :

A860T04870

MITSUBISHI MOTORS :

MD607430

Unit no.

MITSUBISHI

A1T22971	A1T25077	A3T03291	A3T03292	A3T03298	A3T45191
A3T45291	A4T25172	A4T25191	A4T25199		

MITSUBISHI MOTORS

MD025215	MD025235	MD060901	MD062007		
----------	----------	----------	----------	--	--

NISSAN

23100-B9810

RM-62

*71mm Mtg. Length
*6-35 Amp Diodes



Replaces

MAZDA :

D401-24-510B

MITSUBISHI :

134373 A860T11270

Unit no.

MAZDA

D501-18-300 GE01-18-300

MITSUBISHI

A1T23277	A1T23377	A1T31371	A1T31374	A1T31377	A3T03291
A3T03292	A3T03298	A3T45191			

RM-63

*71mm Mtg. Length
*6-35 Amp Diodes



Replaces

MAZDA :

D501-24-510 GE01-24-510

MITSUBISHI :

A860T07170

Unit no.

MAZDA

D401-18-300 H612-18-300

MITSUBISHI

A1T23377	A1T31374	A1T31377	A1T3377
----------	----------	----------	---------

RM-64

*71mm Mtg. Length
*6-35 Amp Diodes

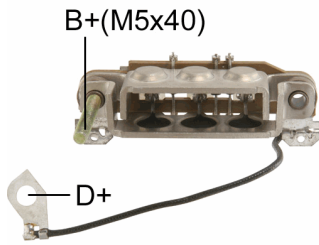

Replaces

MAZDA :

S201-24-510 S501-24-510

MITSUBISHI :

A860T06570

Unit no.

MAZDA

S201-18-300A S241-18-300 S2T3-18-300 S501-18-300 S509-18-300

MITSUBISHI

A001T31371 A001T31374 A1T31179 A1T31579

RM-65

*80mm Mtg. Length
*6-35 Amp Diodes

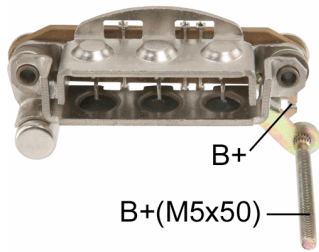

Replaces

LUCAS :

21513130 UBJ256

MAGNETI MARELLI :

940038257

MITSUBISHI :

A860T08270

MITSUBISHI MOTORS :

MD607616

Unit no.

MITSUBISHI

A5T15584 A5T15684 A5T15784 A5T15884 A5T20484 A5T21684

A5T22484

MITSUBISHI MOTORS

MD013740 MD061818 MD068565 MD069859 MD072582 MD086016

RM-66

*80mm Mtg. Length
*6-35 Amp Diodes

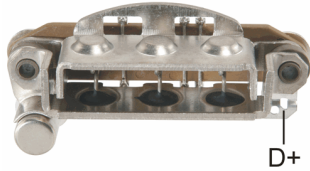

Replaces

LUCAS :

21513107 UBJ257

MAZDA :

N221-24-510

MITSUBISHI :

A860T06070 A860T06082 A860T06470

MITSUBISHI MOTORS :

MD607568

Unit no.

MAZDA

HE45-18-300 N221-18-300

MITSUBISHI

A5T10271 A5T15171 A5T15177 A5T15371 A5T15471 A5T20374

A5T20377 A5T20571 A5T20577 A5T21071 A5T21077 A5T21171

A5T23277 HE4518300A

MITSUBISHI MOTORS

MD015040 MD015041 MD034130 MD034132 MD063781 MD064066

MD064067 MD064068 MD104744

RM-67

*80mm Mtg. Length
*6-35 Amp Diodes

B+(M5x40)



Replaces

LUCAS :

21513134

MAZDA :

E356-24-510 E563-24-510

MITSUBISHI :

A860T10770

Unit no.

MAZDA

E331-18-300A E563-18-300A E5A1-18-300A

MITSUBISHI

A5T21471 A5T21472 A5T30171

RM-68

*85mm Mtg. Length
*6-35 Amp Diodes

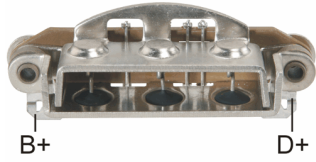

Replaces

LUCAS :

21513100 UBJ219

MAGNETI MARELLI :

940038247

MAZDA :

8173-24-510

MITSUBISHI :

A860T03970 A860T05170

MITSUBISHI MOTORS :

MD607370 MD607441

Unit no.

MAZDA

8341-18-300 8492-18-300 E303-18-300

MITSUBISHI

A2T12371 A2T12671 A2T16371 A2T16471 A2T16477 A2T16871

A2T17172 A2T20972 A2T23071 A2T23271 A2T23471 A2T23474

A2T23477 A2T23494 A2T24172 A2T24272 A2T24371 A2T24372

A2T24377 A2T24671 A2T24771 A2T24971 A2T24972 A2T25772

AQ2240K1 AQ2245G AQ2245G1 AQ2245K1 AQ2250 AQ2250G1

AQ2250G7 AQ2250K1

MITSUBISHI MOTORS

MD006187 MD006197 MD007509 MD009052 MD009053 MD009054

MD022572 MD022578 MD022579 MD027660 MD027661 MD041700

NISSAN

23100-D0111 23100-H7711 23100-H9011 23100-N9511 23100-P2518 23100-Q4511

23100-Q7111 23100-W1502 23100W28100 23100-W7015

RM-69

*85mm Mtg. Length
*6-35 Amp Diodes

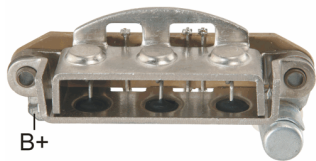

Replaces

MAZDA :

8173-24-510A

MITSUBISHI :

A860T07270

Unit no.

MAZDA

1480-18-300 8173-18-300B E302-18-300

MITSUBISHI

A2T23471 A2T23474 A2T23477 A2T23494 A2T25071 A2T26072

RM-70

*85mm Mtg. Length
 *Same as RM-83 Except with P Terminal.
 *6-35 Amp Diodes

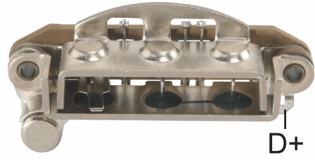

Replaces

MAZDA :

FE01-24-510A HE412-45-10

MITSUBISHI :

A860T08370 A860T10470

Unit no.

MAZDA

F601-18-300A F807-18-300A FE01-15-300B FE01-18-300B H834-18-300 HE19-18-300A

HE41-18-300

MITSUBISHI

A2T31677 A2T31977 A2T40374 A2T40377 A2T40571 A2T40577

A2T40671 A2T40773 A2T41091 A2T41191 A2T41371 A2T41377

RM-71

*85mm Mtg. Length
 *6-35 Amp Diodes

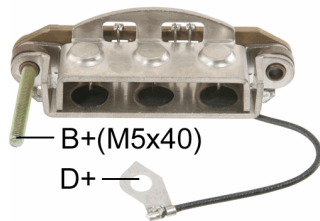

Replaces

MAZDA :

8599-24-510

MITSUBISHI :

A860T06370

Unit no.

MITSUBISHI

859918300 A2T25479 A2T25679 S50218300C

RM-72

*85mm Mtg. Length
 *Same as RM-69 Except with P Terminal.
 *6-35 Amp Diodes

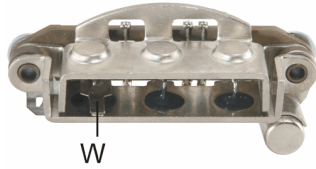

Replaces

LUCAS :
 21513101 UBJ292
MITSUBISHI :
 A860T07270

Unit no.

MAZDA					
1480-18-300	3841-18-300	8173-18-300B	8302-18-300		
MITSUBISHI					
A2T23471	A2T23474	A2T23477	A2T23494	A2T25071	A2T26072

RM-73

*85mm Mtg. Length
 *6-35 Amp Diodes

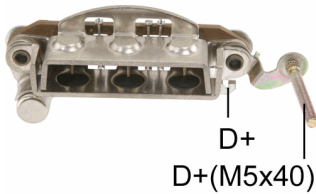

Replaces

LUCAS :
 21513105 UBJ302
MAZDA :
 S215-24-510
MITSUBISHI :
 A860T08770 A860T15170
MITSUBISHI MOTORS :
 MD607680 ME700636 ME700836
NISSAN :
 23230-04D00

Unit no.

MAZDA					
RF03-18-300C					
MITSUBISHI					
A002T72576	A2T27176	A2T27376	A2T40483	A2T40484	A2T41477
A2T41483	A2T41599	A2T41899	A2T43183	A2T43583	A2T72186
A2T72188	A2T72189	A2T72190	A2T72286	A2T72299	A2T72378
A2T72383	A2T72576	A2T72676	A2T72776	A2T72893	A2T73176
A2T73499	A2T73586	A2T74599	A2T75686		
MITSUBISHI MOTORS					
MD050190	MD061430	MD087246	MD607680	ME007582	ME017562
ME017585	ME017602	ME037616	ME037640	ME057658	ME067522
ME067622	ME087501	ME087595	ME087642	ME700836	S51618300
SE4718300	SL2118300A	SL2418300	SL5618300A		
NISSAN					
23100-04D00	23100-04D01				

RM-74

*100mm Mtg. Length
 *6-35 Amp Diodes

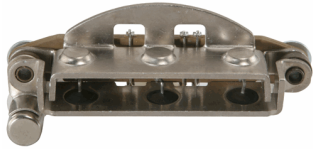

Replaces

LUCAS :

21513128

MAZDA :

4130-24-510B FE05-24-510

MITSUBISHI :

A860T10370 A860T11370

MITSUBISHI MOTORS :

MD607818

Unit no.

MAZDA

8356-18-300	8574-18-300	FE05-18-300B	HE21-18-300A	HE26-18-300B	N236-18-300
-------------	-------------	--------------	--------------	--------------	-------------

MITSUBISHI

A3T21278	A3T21677	A3T34077	A3T34391	A3T34572	A3T34672
----------	----------	----------	----------	----------	----------

A3T34677	A3T35091				
----------	----------	--	--	--	--

MITSUBISHI MOTORS

MD086046	MD086047	MD086048			
----------	----------	----------	--	--	--

NISSAN

23100-05P11

RM-75

*100mm Mtg. Length
*6-35 Amp Diodes



Replaces

LUCAS :

21513102 UBJ208

MAGNETI MARELLI :

940038246

MAZDA :

4130-24-510A 4130-24-560 E301-24-510A

MITSUBISHI :

A860T04170 A860T05270 A860T07370 A860T07770

MITSUBISHI MOTORS :

MD607385 MD607529

NISSAN :

23124-Q4610

Unit no.

MAZDA

4119-18-300 4130-18-300 4199-18-300 E301-18-300C E301-18-300D

MITSUBISHI

A2T25171 A2T26172 A3T21277 A3T21278 A3T21371 A3T21471

A3T21677 A3T32172 A3T32271 A3T32272 A3T32377 A3T32674

A3T32771 A3T32772 A3T32872 A3T32877 A3T33272 A3T33377

A3T33772 A3T33977 AQ2355G1

MITSUBISHI MOTORS

MD018230 MD022576 MD025677 MD025679 MD041705 MD041706

NISSAN

23100-D0211 23100-P3016 23100-Q0811 23100-Q4611 23100-W1615 23100-W5816

23100-W7510 24468-28100

RM-76

*100mm Mtg. Length
*6-35 Amp Diodes

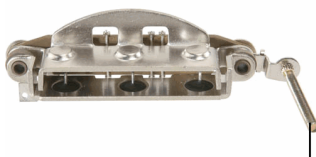

B+(M5x53)

Replaces

LUCAS :

21511121 UBJ220

MAGNETI MARELLI :

940038256

MITSUBISHI :

A860T11770

NISSAN :

23124-05E16

Unit no.

MITSUBISHI

A003T35278 A003T35299A A3T35278

NISSAN

23100-05E17 23100-05E18 23100-05E70

RM-77

*71mm Mtg. Length
*6-35 Amp Diodes

B+(M5x37)

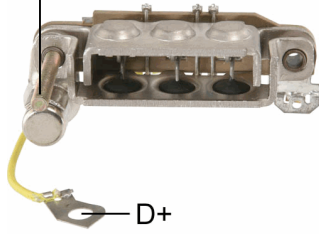

Replaces

MITSUBISHI :
A860T06970

Unit no.

MAZDA		
S201-18-300A	S202-18-300A	S241-18-300A
MITSUBISHI		
A1T23479	A1T23579	A1T32779

RM-78

*71mm Mtg. Length
*6-35 Amp Diodes

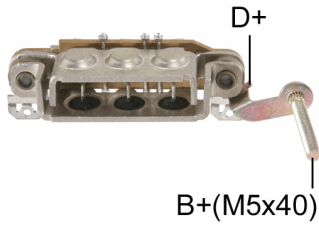

Replaces

MAZDA :
S205-24-510
MITSUBISHI :
A860T08570

Unit no.

MAZDA					
S515-18-300	SE45-18-300	SL01-18-300	SL07-18-300	SL44-18-300A	SL50-18-300C
MITSUBISHI					
A1T33576	A1T33676	A1T71076	A1T71176	A1T71276	A1T71576
MITSUBISHI MOTORS					
S51518300	SE4518300	SL0118300	SL0718300	SL4418300A	SL5018300C

RM-80

*100mm Mtg. Length
*M5 Battery Post
*6-30 Amp Diodes
*O.E. Compatible

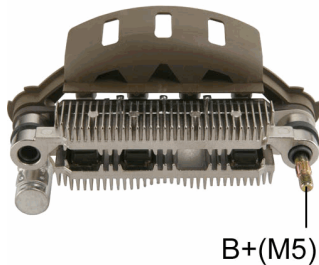

Replaces

MITSUBISHI :
A860T26470

Unit no.

MITSUBISHI	
A3T01877	A3T01877A

RM-81

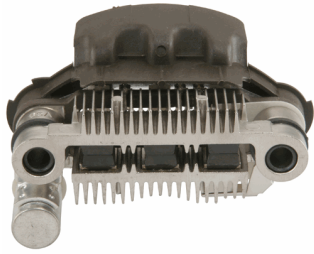

- *64mm Mtg. Length
- *6-30 Amp Diodes
- *O.E. Compatible

Replaces

MITSUBISHI :

A860T18870 A860T18899

NISSAN :

23124-17B10

Unit no.

MITSUBISHI

A5T01892 A5T22971B A5T22997 A5T22997B

RM-82

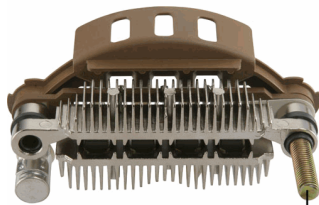

B+(M8)

- *100mm Mtg. Length
- *M8 Battery Post
- *8-30 Amp Diodes
- *O.E. Compatible

Unit no.

MITSUBISHI

A4T02891 A4T02891A A4T02891B A4T02892 A4T02892A A4T03292
 A4T03292A

RM-83

*85mm Mtg. Length
*6-35 Amp Diodes

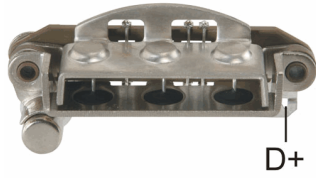

Replaces

MAZDA :

FE01-24-510A HE41-24-510

MITSUBISHI :

A860T08370 A860T10470

MITSUBISHI MOTORS :

MD607693

Unit no.

MAZDA

F601-18-300A	F807-18-300A	FE01-18-300B	H834-18-300	HE19-18-300A	HE41-18-300
--------------	--------------	--------------	-------------	--------------	-------------

MITSUBISHI

A2T31677	A2T31977	A2T40374	A2T40377	A2T40571	A2T40577
----------	----------	----------	----------	----------	----------

A2T40671	A2T41191	A2T41371	A2T41377	A2T41991	
----------	----------	----------	----------	----------	--

MITSUBISHI MOTORS

MD015020	MD015021	MD019179	MD025679	MD074645	
----------	----------	----------	----------	----------	--

RM-84

*71mm Mtg. Length
*M5 Battery Post
*6-35 Amp Diodes
*For use on:
*MAZDA Titan E2500,E3000 series.

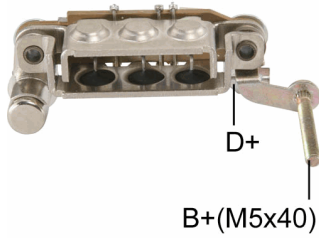

Replaces

MITSUBISHI :

A860T12870

RM-85

*80mm Mtg. Length
*6-35 Amp Diodes

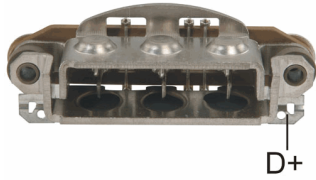

Replaces

LUCAS :

21511122

MITSUBISHI :

A860T08470

NISSAN :

23124-W5811

Unit no.

MITSUBISHI

A5T00272

A5T20871

A5T20872

A5T21871

A5T21897

NISSAN

23100-05B10

23100-10B10

23100-27G10

23100-M6610

23100-N9512

RM-86

*80mm Mtg. Length
*M5 Battery Post
*6-35 Amp Diodes

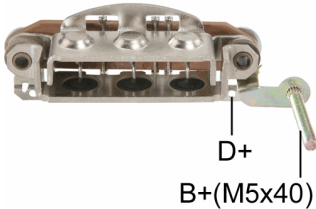

Replaces

MITSUBISHI :

A860T14570

MITSUBISHI MOTORS :

ME700555

Unit no.

MITSUBISHI

A5T22578

A5T22583

A5T70178

A5T70183

A5T70283

MITSUBISHI MOTORS

ME001570

ME007577

ME007578

ME017560

ME017561

RM-87

*100mm Mtg. Length
*M8 Battery Post
*6-30 Amp Diodes
*O.E. Compatible

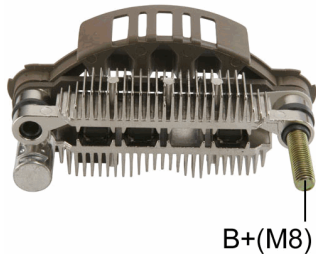

Unit no.

MITSUBISHI

A3TA0591

A3TA0591C

A3TA0591D

A3TA0591E

A3TA0591F

A3TA0593C

A3TA0791

RM-88

- *71mm Mtg. Length
- *M5 Battery Post
- *6-35 Amp Diodes



B+(M5x40)

D+

Replaces

MITSUBISHI :
A860T09470

NISSAN :
23124-U0114

Unit no.

MITSUBISHI

3066856101	3066857101	3066859601	A1T22581	A1T24371	A1T24471
A1T25477	A1T25483	A1T70883			

NISSAN

23100-M0414	23100-U0114
-------------	-------------

RM-89

- *100mm Mtg. Length
- *M8 Battery Post
- *8-30 Amp Diodes
- *O.E. Compatible

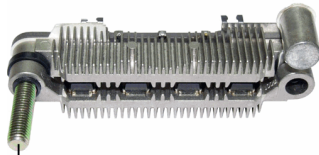

B+(M8x30)

Unit no.

MITSUBISHI

A4T00891	A4T00991	A4T03392	A4T03492
----------	----------	----------	----------

RM-90

- *85mm Mtg. Length
- *M6 Battery Post
- *6-30 Amp Diodes
- *O.E. Compatible

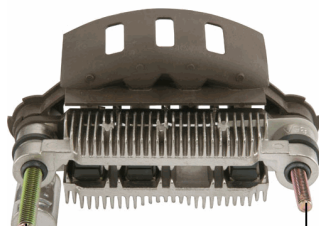

B+(M6x32)

D+(M5x20)

Unit no.

MITSUBISHI

A2T81891	A2TA2591
----------	----------

RM-91

*71mm Mtg. Length
*6-35 Amp Diodes



B+

Replaces

MAGNETI MARELLI :
940038275

Unit no.

MITSUBISHI

A3T03291	A3T03291B	A3T03292	A3T03298	A3T03298A	A3T03298B
A3T45191	A3T45292				

RM-92

*85mm Mtg. Length
*M6 Battery Post
*6-30 Amp Diodes
*O.E. Compatible

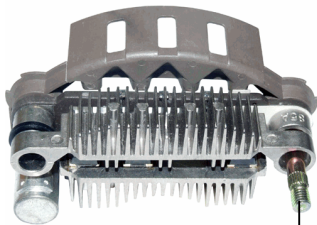

B+ (M6x18)

Replaces

MAZDA :
BPE8-18-W60

Unit no.

MAZDA

B6BF-18-360

MITSUBISHI

A2T39391	A2TA3991
----------	----------

RM-94

*85mm Mtg. Length
*M5 Battery Post
*6-30 Amp Diodes
*O.E. Compatible



B+(M5)

Replaces

MITSUBISHI :
A860T06870

Unit no.

MITSUBISHI

A2TA1991	A2TA1991D	A2TA1994	A2TA1994B	A2TA1994C	A2TA1994D
A2TA2091D	A2TA2091E	A2TA2091F	A2TA2094	A2TA2094B	A2TA2094C
A2TA2094D					

RM-95HV

B+(M5)



- *75mm Mtg. Length
- *M5 Battery Post
- *O.E. Compatible Design with 8-50 Amp Diodes
- *RM-95 With Block Diodes

Replaces

MITSUBISHI :
A860T18570

Unit no.

MITSUBISHI
A2T46591

RM-96

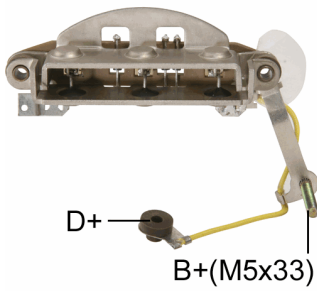

- *100mm Mtg. Length
- *M5 Battery Post
- *6-35 Amp Diodes

Replaces

MITSUBISHI :
A860T06270
NISSAN :
23124-W1715

Unit no.

MITSUBISHI
A3T33678 A3T33684 A3T33698

RM-97HV

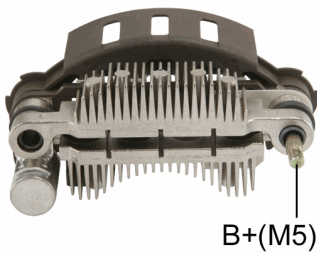

- *85mm Mtg. Length
- *M5 Battery Post
- *OE Compatible Design with 6-50 Amp Diodes
- *RM-97 With Block Diodes

Replaces

MITSUBISHI :
A860T41670

Unit no.

MITSUBISHI
A2T36478

RM-98

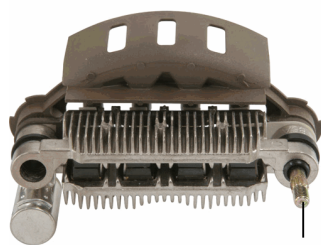

B+(M5)

- *85mm Mtg. Length
- *M5 Battery Post
- *8-30 Amp Diodes
- *Same as RM-38 except RM-98 is with 8 diodes

Replaces

MITSUBISHI :

A860T33470 A860T38270

Unit no.

MITSUBISHI

A2T17574 A2T18874 A2T34477

RM-99HV

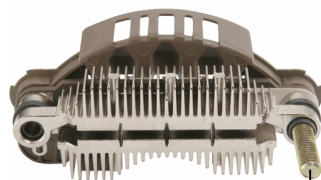

B+(M8)

- *100mm Mtg. Length
- *M8 Battery Post
- *O.E. Compatible Design with 8-50 Amp Diodes
- *RM-99 With Block Diodes

Unit no.

MITSUBISHI

A3TN1791

RP-44A

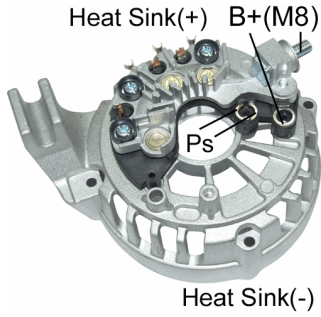

- *103mm OD
- *6-50A Avalanche Diodes
- *Negative & Positive Assembly

Unit no.

DELCO					
10317647	10440635				
VALEO					
2542558	2650010	2650016	SG10S029	SG10S035	SG10S037
SG12S029	SG12S035				

RP-59

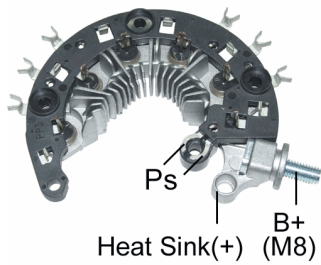

- *114mm OD
- *M8 Battery Post
- *6-50A Avalance Diodes

Unit no.

BMW	
12317521178	12317525376

Used On

BMW		
325i	N52B30A	2005-2007
330	N52B30O0	2005-
520i	N46B20B	2007-2010
523i	N52B25A	2007-
525i	N52B25O0	2005-2010
530i	N52B30O0	2007-
525i Touring	N52B25O0	2005-2007
630i	N52B30O0	2004-2007
730i	N52B30O0	2005-2007
530i Touring	N52B30A	2007-
325i Coupe	N52B25O0	2006-
325i Convertible	N52B25A	2007-
318 d	M47D20U2	2005-2007

RP-64

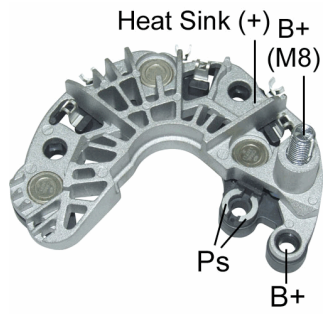

- *3-50A Avalanche Diodes
- *M8 Battery Post
- *Positive rectifier

Replaces

VALEO :

20030412	20030919	20050726	2600172	2604417
----------	----------	----------	---------	---------

Unit no.

HYUNDAI

37300-38400

VALEO

18470128	20090724	A0002655009	TG11C028
----------	----------	-------------	----------

RU-01

*6-25 Amp Diodes

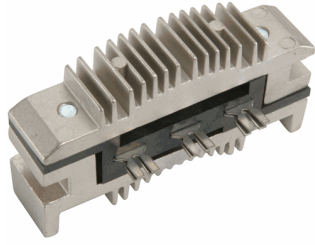

Replaces

VALEO :

NC013 NC014

VALEO(DUCELLIER) :

581025	581071	581078	593074	606625	611197
611199	611788	618093	618439	618503	618720
690260	690971				

Unit no.

VALEO(DUCELLIER)

513001A	513001B	513001C	513003A	513003B	513003C
513008A	513008B	513008C	513008D	514006A	514006B
514011A	514011B	514011C	514011D	514012A	514012B
514012C	514012D	514013A	515001A	515002A	515002B
515002C	515003A	515003B	515003C	515009A	515014A
515015A	515016A	515018A	516006A	516006B	516006C
516006D	516006E	516017A	516017B	516020A	516020B
516020C	516020D	516023A	516023B	516023C	516023D
516024A	516024B	516024C	516024D	516025A	516025B
516025C	516026A	516026B	516033A	516033B	516033C
516035A	516035B	516035C	516037A	516037B	516037C
516038A	516038B	516038C	516044A	516044B	516044C
516047A	516048A	516048B	516057A	516057B	516058A
516062A	581207A	581207B	581207C	581207D	581208A
581208B	593009A	593009B	593009C	750A	750B
750C	750D	750E	750F	750G	7527B
7527C	7548A	7549A	7549B	7549C	7549D
7549E	7549F	7549G	7558A	7558B	7558C
7575A	7575B	7575C	7575D	7575E	7576A
7577A	7577B	7577C	7577D	7577E	7577F
7577G	7577H	7578A	7578B	7578C	7578D
7581A	7581B	7581C	7582A	7584C	7584D
7585A	7585B	7585C	7585D	7586A	7586B
7586C	7586D	7586E	7591A	7591B	7591C
7591D	7591E	7596A	7596B	7596C	7596D
7596E	7596F	7597A	7597B	7597C	7597D
7597E	7597F				

RU-01H

*RU-01H(35A)
*35 Amp Diodes

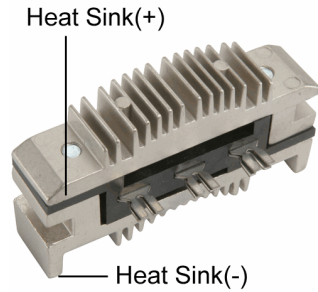

Replaces

VALEO :

NC013 NC014

VALEO(DUCELLIER) :

581025	581071	581078	593074	606625	611197
611199	611788	618093	618439	618503	618720
690260	690971				

Unit no.

VALEO(DUCELLIER)

513001A	513001B	513001C	513003A	513003B	513003C
513008A	513008B	513008C	513008D	514006A	514006B
514011A	514011B	514011C	514011D	514012A	514012B
514012C	514012D	514013A	515001A	515002A	515002B
515002C	515003A	515003B	515003C	515009A	515014A
515015A	515016A	515018A	516006A	516006B	516006C
516006D	516006E	516017A	516017B	516020A	516020B
516020C	516020D	516023A	516023B	516023C	516023D
516024A	516024B	516024C	516024D	516025A	516025B
516025C	516026A	516026B	516033A	516033B	516033C
516035A	516035B	516035C	516037A	516037B	516037C
516038A	516038B	516038C	516044A	516044B	516044C
516047A	516048A	516048B	516057A	516057B	516058A
516062A	581207A	581207B	581207C	581207D	581208A
581208B	593009A	593009B	593009C	750A	750B
750C	750D	750E	750F	750G	7527B
7527C	7548A	7549A	7549B	7549C	7549D
7549E	7549F	7549G	7558A	7558B	7558C
7575A	7575B	7575C	7575D	7575E	7576A
7577A	7577B	7577C	7577D	7577E	7577F
7577G	7577H	7578A	7578B	7578C	7578D
7581A	7581B	7581C	7582A	7584C	7584D
7585A	7585B	7585C	7585D	7586A	7586B
7586C	7586D	7586E	7591A	7591B	7591C
7591D	7591E	7596A	7596B	7596C	7596D
7596E	7596F	7597A	7597B	7597C	7597D
7597E	7597F				

RU-02H

*6-35 Amp Diodes

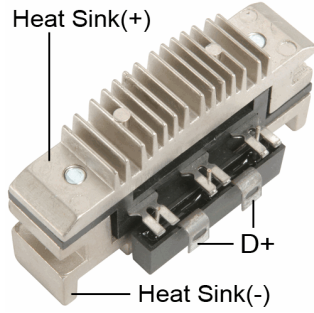

Replaces

DELCO REMY (LUCAS) :
21220366

VALEO :
NB928 NB931

VALEO(DUCELLIER) :

581004	581015	581020	581064	581090	593075
611544	612318	618043	618487	618568	690744
691337					

Unit no.

VALEO(DUCELLIER)

506053A	513002A	513002B	513002C	513004A	513004B
513004C	513005A	513005B	513009D	513010A	513010B
513010C	513010D	513011A	513014A	514002A	514002B
514004A	514005A	514005B	514005C	514005D	514005E
514005F	514007A	514007C	514007D	514007E	514007F
514010A	514010B	514010C	514010D	514014A	515006A
515008A	515008B	515010A	515013A	515014B	516002A
516002B	516002C	516002D	516003A	516003B	516003C
516004A	516004B	516005A	516012A	516012B	516012C
516014A	516019A	516019B	516021A	516027B	516032A
516032B	516040A	516040B	516040C	516041A	516041B
516041C	516046A	516054A	516055A	516055B	7564A
7564B	7569D	7571A	7571B	7571C	7590A
7590B	7590C	7590D	7590E	7595A	7595B
7599A	7599B				

RU-03

*6-25 Amp Diodes

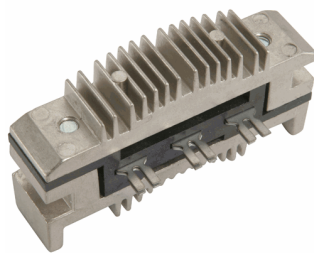

Replaces

VALEO :
NC015

VALEO(DUCELLIER) :
581162 690973

Unit no.

VALEO(DUCELLIER)

516013A	516013B	516013C	516015A	516016A	516016B
516050A	7584E				

RU-03H

*6-35 Amp Diodes

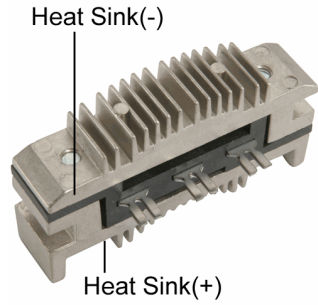

Replaces

VALEO :

NC015

VALEO(DUCELLIER) :

581162 690973

Unit no.

VALEO(DUCELLIER)

516013A	516013B	516013C	516015A	516016A	516016B
516050A	7584E				

RU-04H

*6-35 Amp Diodes

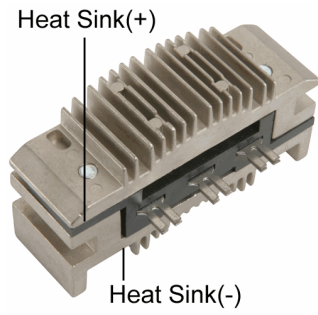

Replaces

VALEO :

NC016

VALEO(DUCELLIER) :

618559 618640 669250 690972 691452

Unit no.

VALEO(DUCELLIER)

433368	436326	515004A	515004B	515005A	515005B
515012A	516008A	516008B	516008C	516008D	516009A
516009B	516009C	516030C	516030D	516030E	516034A
516034B	516042A	516042B	516042C	516045A	516045B
516045C	516049A	516049B	7580A	7580B	7580C
7584B	7593A				

RU-05H

*6-35 Amp Diodes

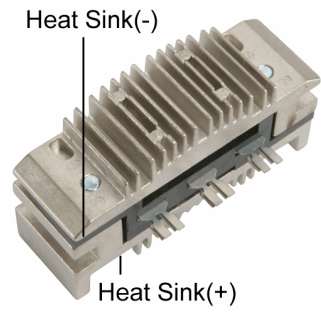

Replaces

VALEO :
NC017

VALEO(DUCELLIER) :
581163 690974 691463

Unit no.

VALEO(DUCELLIER)
516007A 516007B 516007C 516007D 516029A 516029B

RT-01H

*6-35 Amp Diodes

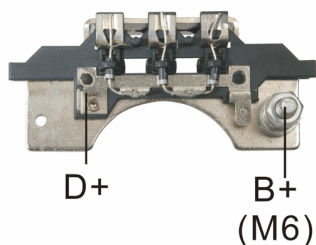

Replaces

LUCAS :

21229200 UBB509

MAGNETI MARELLI :

940038290

VALEO :

2522179 501049 A418320A NB444

VALEO(DUCELLIER) :

593068

VALEO(MOTOROLA) :

501-037 501-038 501-046 501-065 501-46

Unit no.

VALEO(MOTOROLA)

9AL2969F	9AR2682F	9AR2716G	9AR2717G	9AR2718G	9AR2719G
9AR2749G	9AR2750G	9AR2751G	9AR2799G	9AR2814D	9AR2821G
9AR2882F	9AR2887G				

RT-02H

*6-35 Amp Diodes

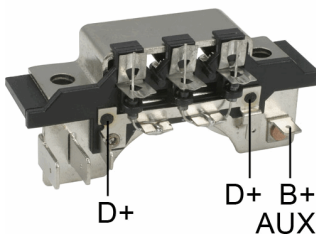

Replaces

MAGNETI MARELLI :

940038287

VALEO :

2522172 2522173 NB427 NB751

VALEO(DUCELLIER) :

593070

VALEO(MOTOROLA) :

501-024 501-063

Unit no.

VALEO(MOTOROLA)

9AR2526F	9AR2527K	9AR2528F	9AR2605L	9AR2610G	9AR2622L
9AR2627G	9AR2636G	9AR2650D	9AR2651D	9AR2652F	9AR2653F
9AR2654G	9AR2655G	9AR2683G	9AR5098F1		

RT-03H

*6-35 Amp Diodes

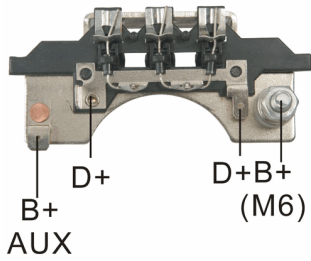

Replaces

LUCAS :
21229204 UBB508

MAGNETI MARELLI :
940038289

VALEO :
2522178 NB095

VALEO(MOTOROLA) :
501-027

Unit no.

VALEO(MOTOROLA)
9AR2662F 9AR2664F 9AR2748G 9AR2828G 9AR2829G 9AR2871F
9AR2875G

RT-04H

*6-35 Amp Diodes

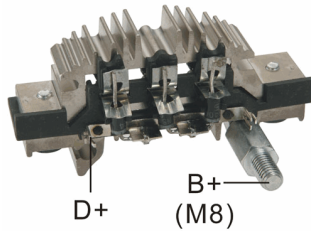

Replaces

VALEO :
2522200

VALEO(MOTOROLA) :
501-104

Unit no.

VALEO(MOTOROLA)
9AR3802L 9AR3835L 9AR6035L 9AR6057L 9AR6058L

RT-05H

*6-35 Amp Diodes

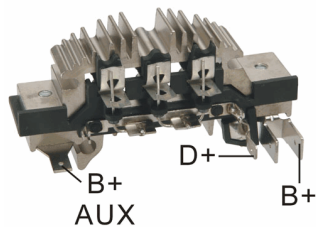

Replaces

LUCAS :

21229192 21229218 UBB506 UBB513

MAGNETI MARELLI :

940038282

VALEO :

2522148 2522165 592555 NB128 NB142 NC481

VALEO(DUCELLIER) :

593073

VALEO(MOTOROLA) :

501-004 501-006 501-007 501-030 501-044 501-058
 501-092 501-105 501-124

Unit no.

VALEO(MOTOROLA)

9AL2615G	9AL2688K	9AL2689K	9AR11711	9AR2512P	9AR2530K
9AR2533P	9AR2539K	9AR2545K	9AR2561K	9AR2562K	9AR2569G
9AR2570G	9AR2594G	9AR2602F	9AR2603F	9AR2604L	9AR2611F
9AR2612G	9AR2613F	9AR2614G	9AR2630K	9AR2637P	9AR2684P
9AR2725F	9AR27459K02	9AR2759K	9AR2759K0	9AR2759K01	9AR2759K02
9AR2784K	9AR2785K	9AR2786K	9AR2833K	9AR2846K	9AR2851K
9AR2852K	9AR2853K	9AR2861K	9AR2862K	9AR2929G	9AR2944K
9AR29631	9AR2963L	9AR2970K	9AR2971G	9AR2972G	9AR2973L
9AR2974L	9AR2975L	9AR2976K	9AR2977L	9AR2981L	9AR2982L
9AR3802L	9AR3825L	9AR5010F	9AR5010K	9AR5028K	9AR5028K0
9AR5028K01	9AR5028K02	9AR5040K	9AR5044K	9AR5046G	9AR5070K
9AR5081K	9AR5082G	9AR5083G	9AR5084L	9AR5085L	9AR5086L
9AR5087K	9AR5088L	9AR5089G	9AR5090L	9AR5092K	9AR5092K0
9AR5092K01	9AR5092K02	9AR5099L	9AR5100G	9AR5101K	9AR5107L
9AR5108K	9AR6053L	9AR6057L	9AR6058L		

RT-06H

*6-35 Amp Diodes
 *Economy Version: RT-06HA

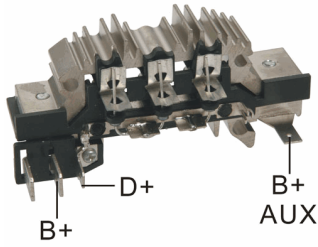

Replaces

BOSCH :

30509

DENSO :

0260002432	0260002540	0260002680	0260002720	0260003190	0260003230
0260003330	0260003350	0260003510	0260003560	0260003570	0260003700
0260003860	0260003861	0260003880	0260003980		

ISKRA :

16905321

ISUZU :

1-81270001-0

LUCAS :

21229191 UBB505

MAGNETI MARELLI :

940038283

NIKKO :

7-44000-0900

VALEO :

NB739	NB744	NB763	NB428	NB435	2522190
-------	-------	-------	-------	-------	---------

VALEO(DUCELLIER) :

593069 592837

VALEO(MOTOROLA) :

501-093	501-001	501-009	501-053	501-076	501-111
---------	---------	---------	---------	---------	---------

Unit no.

VALEO(MOTOROLA)

2941388	9AR2500K	9AR2506K	9AR2511F	9AR2515K	9AR2516F
9AR2517K	9AR2518F	9AR2519F	9AR2520K	9AR2524F	9AR2525K
9AR2709L	9AR2756F	9AR2884L	9AR2897L	9AR2919P	9AR2920P
9AR2997K	9AR5036L				

RT-07H

*6-35 Amp Diodes

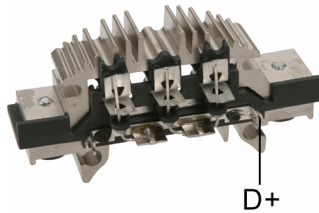

Replaces

LUCAS :

21229193 UBB503

MAGNETI MARELLI :

940038281 940038292

VALEO :

NB117	NB120	NB122	NB123	NB136	NB436
NB439					

VALEO(MOTOROLA) :

501-003	501-008	501-012	501-015	501-019	501-025
501-032	501-039	501-041	501-043	501-047	501-048
501-056	501-062	501-067	501-068	501-071	501-073
501-096	501-098	501-100	501-101	501-102	501-107
501-108	501-112	501-114	501-115	501-118	

Unit no.

VALEO(MOTOROLA)

9AR2501K	9AR2566K	9AR2596K	9AR2714F	9AR2810L	9AR2930G
9AR3599G	9AR5037L	9AR6095G			

RT-08H

*6-35 Amp Diodes

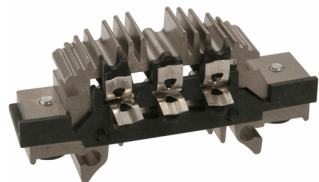

Replaces

LUCAS :

21229194 UBB507

MAGNETI MARELLI :

940038284

VALEO :

2522197	2522208	501077	NB126	NB138	
---------	---------	--------	-------	-------	--

VALEO(MOTOROLA) :

501-002	501-010	501-011	501-017	501-018	501-052
501-057	501-059	501-069	501-103	501-106	501-109
501-110	501-116	501-120	501-123		

Unit no.

VALEO(MOTOROLA)

9AL2502K	9AL2505P	9AL2538K	9AL2559G	9AL2572K	9AL2577G
9AL2583K	9AL2584G	9AL2589K	9AL2590K	9AL2591K	9AL2592K
9AL2593K	9AL2600G	9AL2628P	9AL2834K	9AL2873K	9AL2937K
9AL2939K	9AR2501K	9AR2559G	9AR2572K	9AR2592K	9AR2600G
9AR2834K					

RT-09H

*6-35 Amp Diodes

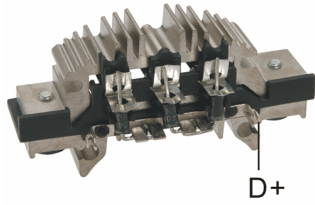

Replaces

LUCAS :

21229203 UBB512

MAGNETI MARELLI :

940038286

VALEO :

2522084 501102 592254 NB787

VALEO(DUCELLIER) :

593027

VALEO(MOTOROLA) :

501-014 501-020 501-060 501-095

Unit no.

VALEO(MOTOROLA)

9AI2617K	9AR2556K	9AR2566K	9AR2638P	9AR2663K	9AR2672P
9AR2673K	9AR2690P	9AR2691G	9AR2692G	9AR2693P	9AR2694P
9AR2714F	9AR2715F	9AR2755P	9AR2794K	9AR2815K	9AR2856K
9AR2904L	9AR2909P	9AR2930G	9AR2941L0	9AR2941L02	9AR2941L03
9AR2964K	9AR2990P	9AR2995R	9AR2998K	9AR3599G	9AR3620G
9AR3649G	9AR3949K	9AR3949K0	9AR3949K01	9AR3949K02	9AR5001K
9AR5062K	9AR5097P	9AR6093K	9AR6095G		

RT-10H

*6-35 Amp Diodes
 *Economy Version: RT-10HA

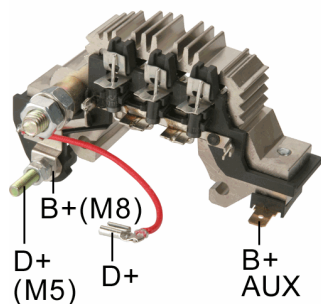

Replaces

AUDI/VW :
 036903359J

LUCAS :
 UBB502

MAGNETI MARELLI :
 940038293

VALEO :
 A940677A

VALEO(MOTOROLA) :
 2523321

Unit no.

AUDI/VW

026903015E

VALEO

026903015EV	026903015EX	026903015EY	0269033015E	049903119L	098603031KV
098603171	098903031KX	2541221	2541222	2541395	2541396
2541402	2541438	436191	436192	436193	436296
436368	436369	436370	436399	436400	A13E02
A13E03	A13E04	A13E05	A13E06	A13E07	A13E08
A13E09	A13E10	A13E11	A13E12	A13E13	A13E21
A13E22	A13E43	A13E47	A13E48	A13E49	A13E54
A13E58					
VALEO(MOTOROLA)					
290-300	290-301	290-302	290-303	290-304	290-306
290-307	290-308	290-309	290-310	290-363	290-365
290-367	290-369	290-371	290-373	290-375	2940300
2940301	2940302	2940303	2940304	2940305	2940306
2940307	2940308	2940309	2940310	2940311	2940363
2940365	2940367	2940369	2940371	2940373	2940375

RT-12H

*6-35 Amp Diodes

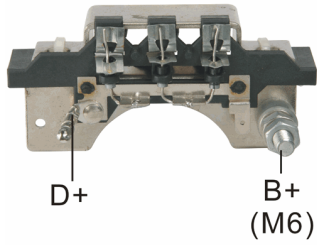

Replaces

MAGNETI MARELLI :

940038288

VALEO :

NB094

VALEO(MOTOROLA) :

501-023

501-026

501-054

Unit no.

VALEO(MOTOROLA)

9AL2633G

9AL2666F

9AL2774G

9AR2633G

9AR2662F

9AR2664F

9AR2729G

9AR2748G

9AR2828G

9AR2829G

9AR2847F

9AR2871G

9AR2875G

RT-13H

*6-35 Amp Diodes

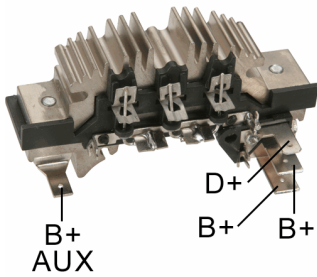

Replaces

LUCAS :

21229220

UBB504

MAGNETI MARELLI :

940038291

VALEO :

A940163A

NB119

VALEO(MOTOROLA) :

2522148

501-030

Unit no.

VALEO(MOTOROLA)

9AR2759

9AR5081K

9AR5082G

9AR5083G

9AR5084L

9AR5085L

9AR5086L

9AR5087K

9AR5088L

9AR5089G

9AR5090L

RT-21H

*6-35 Amp Diodes

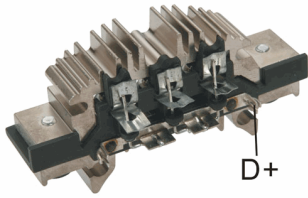

Replaces

LUCAS :

21229202 UBB511

VALEO :

2522190 501079 NB121 NB785

VALEO(MOTOROLA) :

501-034 501-061 501-066 501-078 501-097 501-119

Unit no.

VALEO

433430 433437 433453 436318 510146 510147

RT-23HD

*Industrial Alternator Version
*6-70 Amp Diodes

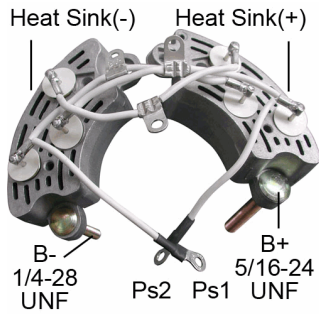

Unit no.

VALEO(MOTOROLA)

110555

RT-24HD

*Industrial Alternator Version
*6-70 Amp Diodes

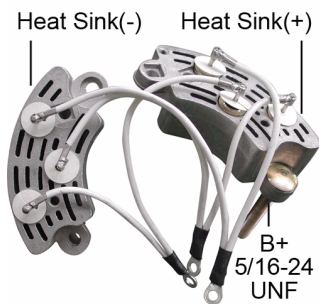

Replaces

VALEO(MOTOROLA) :

101-205

Unit no.

VALEO(MOTOROLA)

110279 110296 110309

RP-01

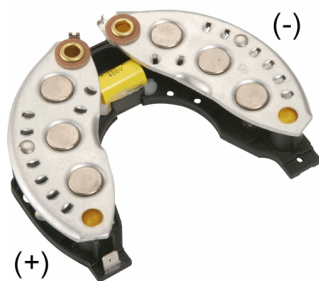

*115mm OD
 *6-35 Amp Diodes
 *With Capacitor

Replaces

DELCO REMY (LUCAS) :

21225386

LUCAS :

UBB232

VALEO :

NC145

VALEO(PARIS RHONE) :

101743 102527 103543 105380 180593

Unit no.

VALEO(PARIS RHONE)

A13N104	A13N110	A13N12	A13N121	A13N13	A13N136
A13N137	A13N139	A13N14	A13N15	A13N150	A13N156
A13N157	A13N158	A13N160	A13N161	A13N162	A13N163
A13N17	A13N187	A13N188	A13N27	A13N29	A13N30
A13N49	A13N50	A13N53	A13N6	A13N64	A13N65
A13N7	A13N85	A13N86	A13N89	A13N97	A14N106
A14N107	A14N12	A14N125	A14N13	A14N131	A14N151
A14N40	A14N50	A14N69	A14N70	A14N85	A14N86

RP-02

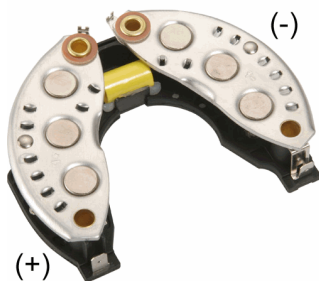

*115mm OD
 *6-35 Amp Diodes
 *With Capacitor, Diode Trio

Replaces

LUCAS :

UBB235

VALEO :

NC136 NC730 592754 593188 593199 593309

VALEO(PARIS RHONE) :

102556 103551 181155

Unit no.

VALEO(PARIS RHONE)

A13N147M	A13N148M	A13N149M	A13N152M	A13N186	A13N1M
A13N28M	A13N2M	A13N33M	A13N34	A13N35M	A13N36M
A13N51	A13N52	A13N57M	A13N66M	A14N100M	A14N112M
A14N118M	A14N119M	A14N122M	A14N137M	A14N47M	A14N81M

RP-03

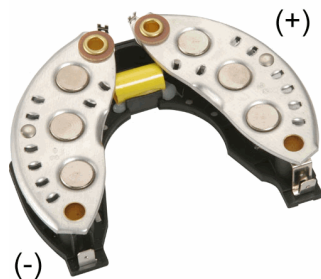

- *115mm OD
- *6-35 Amp Doides
- *With Capacitor

Replaces

SEV MARCHAL :
71215303

VALEO :
NC133 NC139 NC216 NC936

VALEO(PARIS RHONE) :
100157 101217 101759 103539 103576 104292
105135 105135 105629 300082 593194

Unit no.

SEV MARCHAL

71635102	71635602	71635902	71636102	71650002	71650402
71650802	71651802	71651902	71652402	71652602	71770102
71770202					

VALEO(PARIS RHONE)

A13N103	A13N106	A13N113	A13N114	A13N116	A13N120
A13N124	A13N125	A13N126	A13N127	A13N128	A13N146T
A13N159	A13N172	A13N173	A13N18	A13N180	A13N19
A13N20	A13N31	A13N43	A13N62	A13N82	A13N84
A13N87	A13N91	A13N92	A13R258	A14N1	A14N10
A14N101	A14N102	A14N103	A14N113	A14N117	A14N121
A14N130	A14N134	A14N142	A14N150	A14N2	A14N22
A14N35	A14N36	A14N42	A14N51	A14N55	A14N56
A14N59	A14N60	A14N63	A14N64	A14N65	A14N77
A14N83	A14N84	A14N89	A14N9	A14N99	

RP-04

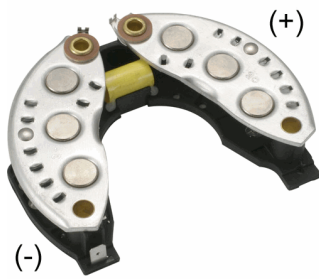

*115mm OD
 *6-35 Amp Diodes
 *With Capacitor, Diode Trio

Replaces

DELCO REMY (LUCAS) :
 21225400

SEV MARCHAL :
 71215003 71215103 71215603 71216203 71216903

VALEO :
 592-596 NC138 NC388 NC877

VALEO(PARIS RHONE) :
 100931 104971 350011

Unit no.

SEV MARCHAL					
71635202	71635502	71635802	71636002	71645002	71650202
71651202	71651302	71651602	71652202	71655002	71655102
71655302	71655502	71770002			
VALEO(PARIS RHONE)					
A13N109	A13N129	A13N25	A13N39	A13N40	A13N41
A13N42	A13N46	A13N47	A13N83	A13N9	A13N94
A14N07	A14N23	A14N78	A14N90	A14N93	A14N97

RP-04H

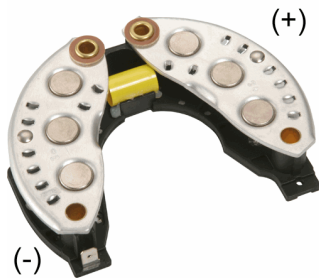

*115mm OD
 *6-50 Amp Diodes
 *With Capacitor

Replaces

LUCAS :
 UBB233

VALEO :
 592595 NC144 101217 101759 103539 103576
 104292 104971 592779 592877 593180

VALEO(PARIS RHONE) :
 180537

Unit no.

VALEO(PARIS RHONE)					
A13N123	A13N178	A13N179	A14N18	A14N91	A14N92

RP-04HR

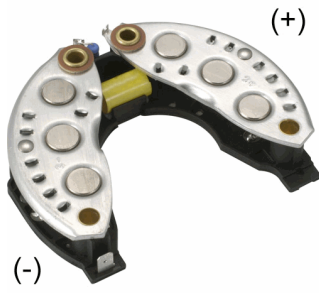

- *115mm OD
- *6-50 Amp Diodes
- *With Capacitor, Resistor, Diode Trio

Replaces

PEUGEOT :
5744.61

VALEO(PARIS RHONE) :
105554 2181241

Unit no.

VALEO(PARIS RHONE)
A13N130 A14N80 A14N82 A14N88

RP-04R

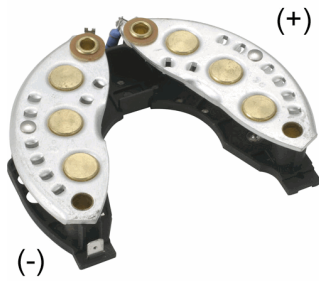

- *115mm OD
- *6-35 Amp Diodes
- *With Resistor, Diode Trio

Replaces

SEV MARCHAL :
71215403

VALEO :
NC134 NC217

VALEO(PARIS RHONE) :
101773 101776 103546

Unit no.

SEV MARCHAL
71635702 71636202 71636302 71636402 71636802 71636902
71651502 71652002 71652102 71652302 71652703 71653102
71653202

VALEO(PARIS RHONE)
A13N32 A13N38 A13N40 A13N41 A13N42 A13N83
A13N94 A13R248 A13R259 A13R266 A13R267 A13R268
A14N23 A14N78

RP-05H

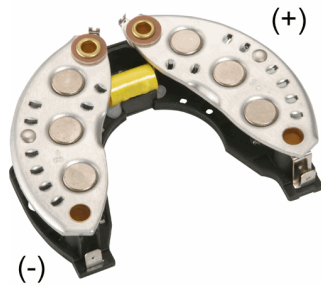

- *115mm OD
- *6-50 Amp Diodes
- *With Capacitor, Diode Trio

Replaces

VALEO(PARIS RHONE) :
101713

Unit no.

VALEO(PARIS RHONE)
A14N11 A14N38 A14N71

RP-06H

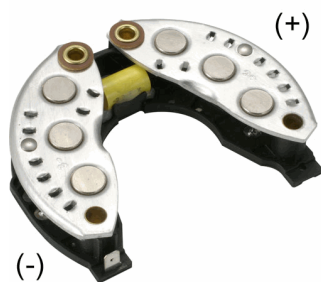

- *115mm OD
- *6-50 Amp Diodes
- *With Capacitor, Diode Trio

Replaces

VALEO :
NC137
VALEO(PARIS RHONE) :
101227 104269

Unit no.

VALEO(PARIS RHONE)
A13N11 A13N133 A13N135 A13N39 A13N44T A13N45T
A13R33

RP-06HR

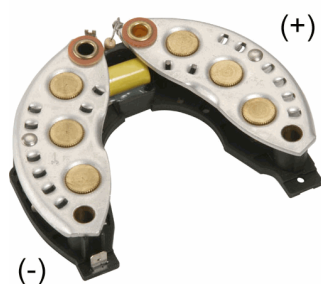

- *115mm OD
- *6-50 Amp Diodes
- *With Capacitor, Resistor, Diode Trio

Replaces

VALEO :
NC161
VALEO(PARIS RHONE) :
101342

Unit no.

VALEO(PARIS RHONE)
A13N22T A13N28T A13N32T A13N3T A13N4T A13N5T
A13N61T

RP-07

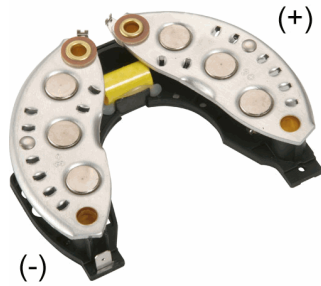

- *115mm OD
- *6-35 Amp Diodes
- *With Capacitor

Replaces

LUCAS :
UBB237

VALEO :
NC141 592881

VALEO(PARIS RHONE) :
105252 105690

Unit no.

VALEO(PARIS RHONE)
A13N171 A13N62 A13N88

RP-08

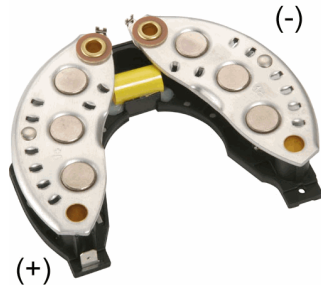

- *115mm OD
- *6-35 Amp Diodes
- *With Capacitor

Replaces

LUCAS :
UBB238

VALEO :
NC143 592880 593190 593193

VALEO(PARIS RHONE) :
104615 105522 105523 106016

Unit no.

VALEO(PARIS RHONE)
A13N107 A13N108 A13N112 A13N117 A13N119 A13N164
A13N185 A13N81 A13N90 A14N132 A14N4 A14N53
A14N54

RP-09

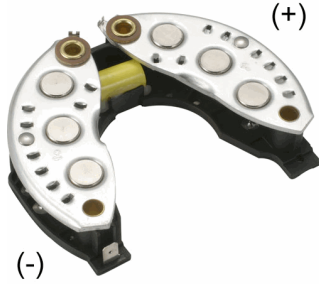

- *115mm OD
- *6-35 Amp Diodes
- *With Capacitor, Diode Trio

Replaces

DELCO REMY (LUCAS) :
21225379

VALEO :
NC976

VALEO(PARIS RHONE) :
592747 592749

Unit no.

VALEO(PARIS RHONE)
A13N181 A13N182 A13N183 A13N218 A13N220

RP-09A

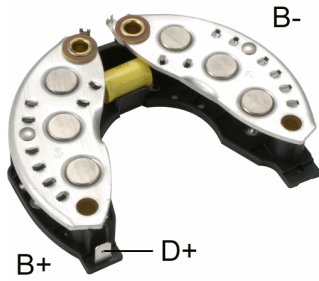

- *115mm OD
- *6-35 Amp Diodes
- *Cut D+ Terminal

Unit no.

VALEO(PARIS RHONE)
A13N220

RP-09R

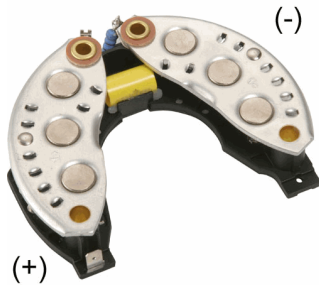

- *115mm OD
- *6-35 Amp Diodes
- *With Capacitor, Resistor, Diode Trio

Replaces

VALEO :
NC142

VALEO(PARIS RHONE) :
105813 592747

Unit no.

VALEO(PARIS RHONE)
A13N167 A13N181 A13N182 A13N95 A14N16

RP-10

*6-25 Amp Diodes



Replaces

VALEO :
NC124

VALEO(PARIS RHONE) :

92086 92785 92919 92928 92939

Unit no.

VALEO(PARIS RHONE)

A11R1	A11R2	A11R3	A11R4	A12R1	A12R10
A12R11	A12R12	A12R13	A12R14	A12R16	A12R17
A12R19	A12R2	A12R20	A12R21	A12R22	A12R23
A12R24	A12R25	A12R26	A12R27	A12R28	A12R3
A12R30	A12R31	A12R32	A12R33	A12R34	A12R36
A12R37	A12R38	A12R4	A12R42	A12R43	A12R44
A12R45	A12R46	A12R47	A12R48	A12R50	A12R52
A12R53	A12R54	A12R55	A12R56	A12R59	A12R6
A12R8	A12R9				

RP-11

*4-35 Amp Diodes



Replaces

VALEO :
NC126

VALEO(PARIS RHONE) :

78810 92734 94450 96314

Unit no.

VALEO(PARIS RHONE)

A11M10	A11M14	A12M1	A12M10	A12M18	A12M2
A12M3	A12M6	A12M7			

RP-13

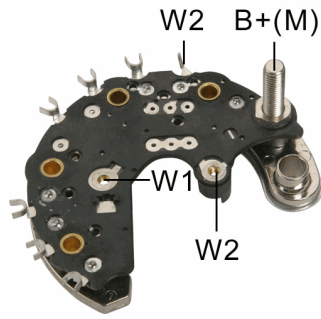

- *107mm OD
- *6-50A Avalanche Diodes
- *w/o Diode Trio

Replaces

CITROEN :
 95644506 5744C9

LUCAS :
 UBB254

VALEO :
 592848

Unit no.

VALEO					
2541356	2541360	2541361	2541362	2541455	436259
436261	436336	436340	436362		
VALEO(PARIS RHONE)					
A11VI15	A11VI16	A11VI17	A11VI18	A11VI47	A11VI48
A13VI101	A13VI102	A13VI31	A13VI48	A13VI85	A13VI86
A13VI87					

RP-14

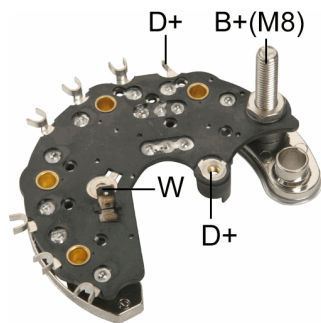

- *107mm OD
- *M8 Battery Post
- *8-50A Avalanche Diodes

Replaces

LUCAS :
 UBB250 UBB251 UBB253

MAGNETI MARELLI :
 940038315 940038326

PEUGEOT :
 5744.02

VALEO :
 NF006

VALEO(PARIS RHONE) :
 2546062 2546076 592844 592917 A546076A

Unit no.

VALEO					
1541683	1541696	1541697	2541348	2541473	2541644
2541656	2541678	2541680	436381	436386	436387
436389					
VALEO(PARIS RHONE)					
A13VI134	A13VI135	A13VI137	A13VI138	A13VI155	A13VI156
A13VI170	A13VI175	A13VI176	A13VI180	A13VI198	A13VI24
A13VI54	A13VI67	A13VI69	A13VI70	A13VI74	A13VI75
A13VI77	A13VI78	A13VI79			

RP-15

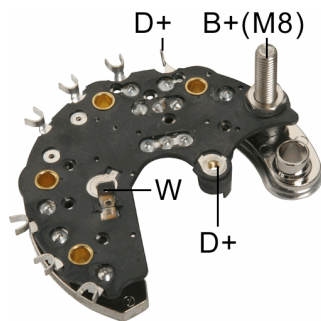

- *107mm OD
- *M8 Battery Post
- *6-50A Avalanche Diodes

Replaces

VALEO :
592845

Unit no.

VALEO(PARIS RHONE)

A11VI10	A11VI11	A11VI23	A11VI24	A11VI25	A13VI46
A13VI49	A11VI32	A11VI33	A11VI37	A11VI40	A11VI43
A11VI44	A11VI45				

RP-16

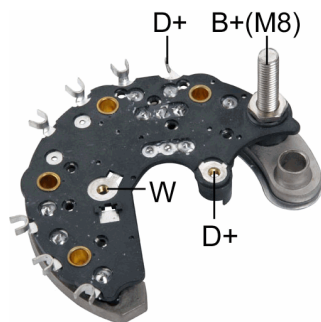

- *107mm OD
- *M8 Battery Post
- *6-50A Avalanche Diodes
- *w/diode trio
- *Same as RP-24 but without spade W terminal

Replaces

VALEO :
592842

Unit no.

VALEO(PARIS RHONE)

A13VI126

RP-17

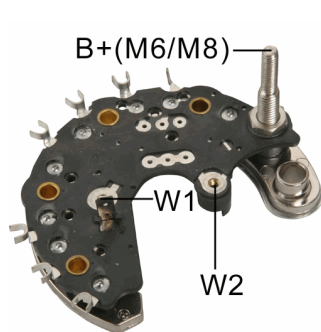

- *107mm OD
- *M6/M8 Battery Post
- *8-50A Avalanche Diodes

Replaces

LUCAS :
UBB252

MAGNETI MARELLI :
940038316

VALEO :
NF007

VALEO(PARIS RHONE) :
2545941 545940 592846 592847

Unit no.

VALEO(PARIS RHONE)					
A11VI104	A11VI105	A11VI106	A11VI107	A11VI11	A11VI13
A11VI131	A11VI29	A11VI30	A11VI31	A11VI59	A11VI61
A13VI14	A13VI153	A13VI16	A13VI17	A13VI20	A13VI21
A13VI22	A13VI23	A13VI25	A13VI28	A13VI30	A13VI32
A13VI34	A13VI35	A13VI45	A13VI47	A13VI52	A13VI55
A13VI57	A13VI62	A13VI64	A13VI65	A13VI66	

RP-18

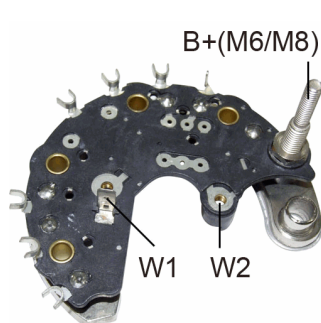

- *107mm OD
- *M6/M8 Battery Post
- *6-50A Avalanche Diodes

Replaces

VALEO(PARIS RHONE) :
2545938 592937 545937

Unit no.

VALEO(PARIS RHONE)	
A11VI26	A11VI28

RP-19

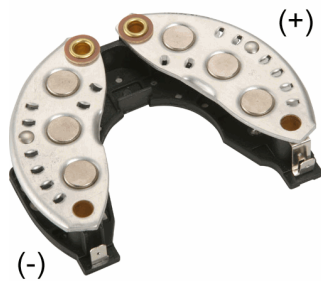

*115mm OD
 *6-35 Amp Diodes
 *Same as RP-03 except RP-19 is without Capacitor

Replaces

VALEO(PARIS RHONE) :
 102817

Unit no.

VALEO(PARIS RHONE)
 A13N37 A13N62 A13N69 A13N76 A14N19

RP-20

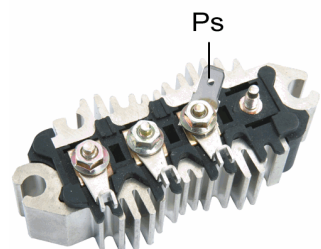

*6-35 Amp Diodes

Replaces

LUCAS :
 UBB256
 VALEO(PARIS RHONE) :
 300903

Unit no.

VALEO(PARIS RHONE)
 A14N104 A14N124 A14N140 A14N67 A14N73 A14N75
 A14N76 A14N95

RP-21

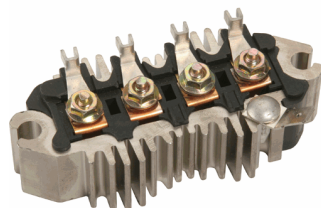

*8-35 Amp Diodes
 *Same as RP-20 but w/8 diodes

Replaces

VALEO(PARIS RHONE) :
 300903

Unit no.

VALEO(PARIS RHONE)
 A14N104 A14N124 A14N140 A14N67 A14N73 A14N75
 A14N76 A14N95

RP-22

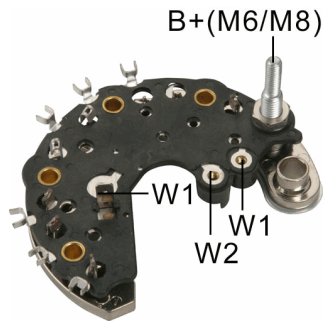

- *107mm OD
- *M6/M8 Battery Post
- *6-50A Avalanche Diodes

Replaces

VALEO :
593175

Unit no.

VALEO(PARIS RHONE)
A11VI54 A11VI76 A11VI77 A11VI79

RP-23

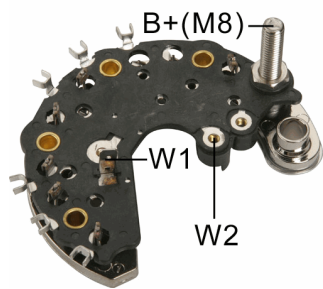

- *107mm OD
- *M8 Battery Post
- *8-50A Avalanche Diodes

Replaces

VALEO :
593174

Unit no.

VALEO(PARIS RHONE)
A13VI118

RP-24

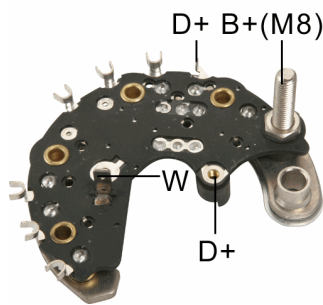

- *107mm OD
- *M8 Battery Post
- *6-50A Avalanche Diodes
- *w/diode trio
- *Same as RP-16 but w/ spade W terminal

Replaces

VALEO :
592842

Unit no.

VALEO(PARIS RHONE)
A13VI126

RP-27

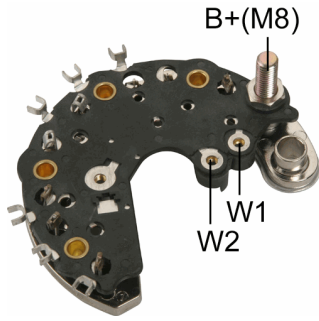

- *107mm OD
- *M8 Battery Post
- *6-50A Avalanche Diodes
- *w/o diode trio

Replaces

VALEO :
593320

Unit no.

VALEO(PARIS RHONE)

A13VI178

A13VI202

A13VI237

A13VI257

RP-28

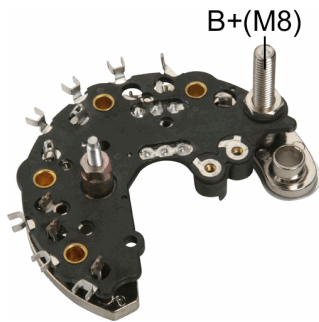

- *107mm OD
- *M8 Battery Post
- *6-50 Amp Avalanche Diodes

Replaces

VALEO(PARIS RHONE) :
593205

Unit no.

VALEO(PARIS RHONE)

A14VI19

A14VI20

RP-35



- *107mm OD
- *M6/M8 Battery Post
- *8-50A Avalanche Diodes

Replaces

VALEO :
593172

Unit no.

VALEO(PARIS RHONE)

A13VI167

RP-36



- *107mm OD
- *M8 Battery Post
- *6-50A Avalanche Diodes

Replaces

VALEO :
546351

RP-37

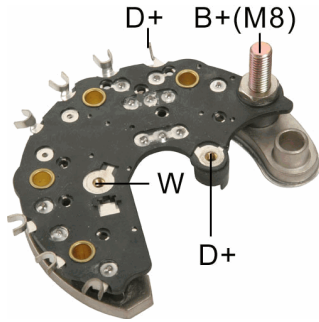

- *107mm OD
- *M8 Battery Post
- *6-50A Avalanche Diodes
- *w/ diode trio

Replaces

VALEO :
2546041 593202 2546040

Unit no.

VALEO(PARIS RHONE)

A14VI10 A14VI11 A14VI13 A14VI130 A14VI131 A14VI14

RP-38

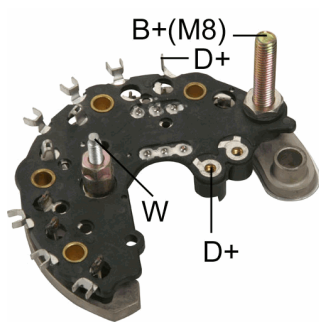

- *107mm OD
- *M8 Battery Post
- *6-50A Avalanche Diodes

Replaces

VALEO :
2548083

Unit no.

VALEO
2542433A

RP-39H

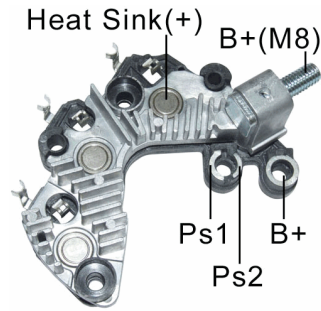

*6-50A Avalanche Diodes
 *w/o Diode Trio
 *Used on Citroen C2/C3/Xsara, Peugeot 307

Replaces

VALEO :
 593487

Unit no.

VALEO
 2542485A 603030256 9642879480

RP-40H

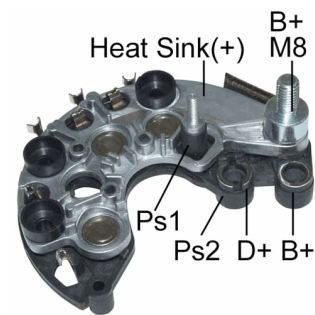

*M8 Battery Post
 *6-50A Avalanche Diodes
 *w/ Diode Trio
 *Used on Renault Magnum, Premium, Maxter

Unit no.

RENAULT
 5010306710
 VALEO
 2542310

SG12B020

RP-41

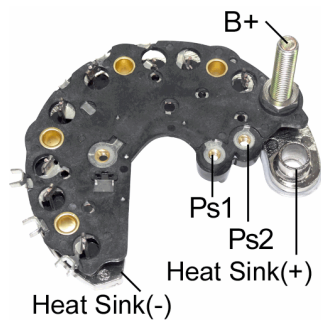

*8-50A Avalanche Diodes

Replaces

VALEO :
 593667

Unit no.

VALEO
 SG15L020 SG15L023 SG15L027

RP-48

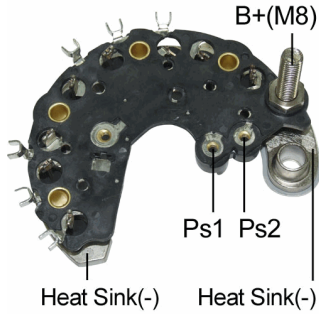

107mm OD
 *M8 Battery Post
 *8-50A Avalanche Diodes

Replaces

VALEO :

593366	593364	593351	593348	593327	593204
592842					

Unit no.

VALEO

A11VI10	A11VI110	A11VI111	A11VI87	A11VI88	A11VI94
A11VI95	A11VI98	A13VI10	A13VI126	A13VI130	A13VI150

RP-51

*103mm OD
 *M8 Battery Post
 *3-50A Avarance Diodes

Replaces

VALEO :

593530	235653
--------	--------

Unit no.

VALEO

SG10B021	SG10B022	SG10B023	SG10B048
----------	----------	----------	----------

RT-19H

*6-35 Amp Diodes
 *Economy Version: RT-19HA

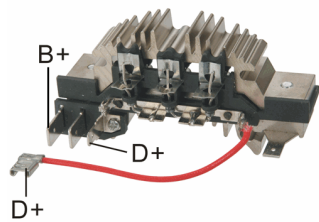

Replaces

ISKRA :

16906614

RT-20H

*6-35 Amp Diodes
*Economy Version: RT-20HA

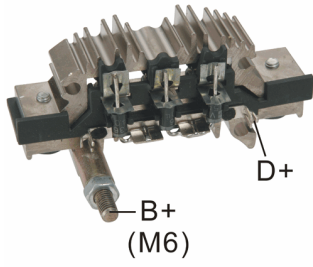

Replaces

VALEO(PARIS RHONE) :
592893

Unit no.

VALEO(PARIS RHONE)
S13E50

Diode & Diode Trio

DD-1001



*Negative
*25A/400V, 4 μ A
*Pressfit Flag Lead
*Diameter(mm):1/2"
*Lead(mm):1.3

DD-1002



*Positive
*25A/400V, 4 μ A
*Pressfit Flag Lead
*Diameter(mm):1/2"
*Lead(mm):1.3

DD-1003



*Negative
*35A/400V, 4 μ A
*Pressfit Insulated Lead
*Diameter(mm):1/2"
*Lead(mm):1.3

DD-1004



*Positive
*35A/400V, 4 μ A
*Pressfit Flag Lead
*Diameter(mm):1/2"
*Lead(mm):1.3

Diode & Diode Trio

DD-1005



*Negative
*25A/400V, 4 μ A
*Pressfit Hook Lead
*Diameter(mm):1/2"
*Lead(mm):1.3

DD-1006



*Positive
*25A/400V, 4 μ A
*Pressfit Hook Lead
*Diameter(mm):1/2"
*Lead(mm):1.3

DD-1007



*Negative
*25A/400V, 4 μ A
*Straight Lead, Tin Can
*Diameter(mm):5/16"mm
*Lead(mm):1.5 X 26L

DD-1008



*Positive
*25A/400V, 4 μ A
*Straight Lead, Tin Can
*Diameter(mm):5/16"mm
*Lead(mm):1.5 X 26L

Diode & Diode Trio

DD-1010



*Negative
*35A/400V, 4 μ A
*Straight Lead, Tin Can
*Diameter(mm):5/16"mm
*Lead(mm):1.5 X 26L

DD-1011



*Positive
*35A/400V, 4 μ A
*Straight Lead, Tin Can
*Diameter(mm):5/16"mm
*Lead(mm):1.5 X 26L

DD-1012



*Negative
*25A/400V, 4 μ A
*Pressfit Straight Lead
*Diameter(mm):1/2"mm
*Lead(mm):1.3 X 33.5L

DD-1013



*Positive
*25A/400V, 4 μ A
*Pressfit Straight Lead
*Diameter(mm):1/2"mm
*Lead(mm):1.3 X 33.5L

Diode & Diode Trio

DD-1014



*Negative
*35A/400V, 4 μ A
*Pressfit Straight Lead
*Diameter(mm):1/2"mm
*Lead(mm):1.3 X 33.5L

DD-1015



*Positive
*35A/400V, 4 μ A
*Pressfit Straight Lead
*Diameter(mm):1/2"mm
*Lead(mm):1.3 X 33.5L

DD-1016



*Negative
*35A/400V, 4 μ A
*Pressfit Hook Lead
*Diameter(mm):1/2"
*Lead(mm):1.3

DD-1017



*Positive
*35A/400V, 4 μ A
*Pressfit Hook Lead
*Diameter(mm):1/2"
*Lead(mm):1.3

Diode & Diode Trio

DD-1020



- *Negative
- *25A/400V, 4 μ A
- *Pressfit Straight Lead
- *Bosch Type
- *Diameter(mm):12.8
- *Lead(mm):1.3 X 29L

DD-1021



- *Positive
- *25A/400V, 4 μ A
- *Pressfit Straight Lead
- *Bosch Type
- *Diameter(mm):12.8
- *Lead(mm):1.3 X 29L

DD-1022



- *Negative
- *35A/400V, 4 μ A
- *Pressfit Straight Lead
- *Bosch Type
- *Diameter(mm):12.8
- *Lead(mm):1.3 X 29L

DD-1023



- *Positive
- *35A/400V, 4 μ A
- *Pressfit Straight Lead
- *Bosch Type
- *Diameter(mm):12.8
- *Lead(mm):1.3 X 29L

Diode & Diode Trio

DD-1024



*Negative
*50A/400V, 4 μ A
*Pressfit Straight Lead
*Bosch Type
*Diameter(mm):12.8
*Lead(mm):1.3 X 29L

DD-1025



*Positive
*50A/400V, 4 μ A
*Pressfit Straight Lead
*Bosch Type
*Diameter(mm):12.8
*Lead(mm):1.3 X 29L

DD-1026



*Negative
*50A/400V, 4 μ A
*Pressfit Straight Lead
*Diameter(mm):1/2"mm
*Lead(mm):1.3 X 33.5L

DD-1027



*Positive
*50A/400V, 4 μ A
*Pressfit Straight Lead
*Diameter(mm):1/2"mm
*Lead(mm):1.3 X 33.5L

Diode & Diode Trio

DD-1028



*Negative
*50A/400V, 4 μ A
*Pressfit Flag Lead
*Diameter(mm):1/2"
*Lead(mm):1.3

DD-1029



*Positive
*50A/400V, 4 μ A
*Pressfit Flag Lead
*Diameter(mm):1/2"
*Lead(mm):1.3

DD-1030



*Negative
*50A/400V, 4 μ A
*Pressfit Hook Lead
*Diameter(mm):1/2"
*Lead(mm):1.3

DD-1031



*Positive
*50A/400V, 4 μ A
*Pressfit Hook Lead
*Diameter(mm):1/2"
*Lead(mm):1.3

Diode & Diode Trio

DD-1034



*Negative
*35A/400V, 4 μ A
*Pressfit Straight Lead
*Motorola Type
*Diameter(mm):12.8
*Lead(mm):1.3 X 29.1L

DD-1035



*Positive
*35A/400V, 4 μ A
*Pressfit Straight Lead
*Motorola Type
*Diameter(mm):12.8
*Lead(mm):1.3 X 29.1L

DD-1036



*Negative
*50A/400V, 4 μ A
*Pressfit Straight Lead
*Motorola Type
*Diameter(mm):12.8
*Lead(mm):1.3 X 29.1L

DD-1037



*Positive
*50A/400V, 4 μ A
*Pressfit Straight Lead
*Motorola Type
*Diameter(mm):12.8
*Lead(mm):1.3 X 29.1L

Diode & Diode Trio

DD-1038



*Negative
*35A/400V, 4 μ A
*Pressfit Straight Lead
*Lucas Type
*Diameter(mm):10
*Lead(mm):1.3 X 29L

DD-1039



*Positive
*35A/400V, 4 μ A
*Pressfit Straight Lead
*Lucas Type
*Diameter(mm):10
*Lead(mm):1.3 X 29L

DD-1040



*Negative
*25A/400V, 4 μ A
*Dish Type
*Diameter(mm):8.4
*Lead(mm):1.5 X min.21.5L

DD-1041



*Positive
*25A/400V, 4 μ A
*Dish Type
*Diameter(mm):8.4
*Lead(mm):1.5 X min.17.8L

Diode & Diode Trio

DD-1042



*Negative
*35A/400V, 4 μ A
*Dish Type
*Diameter(mm):9.5
*Lead(mm):1.5 X min.21.5L

DD-1043



*Positive
*35A/400V, 4 μ A
*Dish Type
*Diameter(mm):9.5
*Lead(mm):1.5 X min.17.8L

DD-1047



*Negative
*50A/24~32V, 1 μ A
*Avalanche diode
*Motorola Type
*Diameter(mm):12.8
*Lead(mm):1.3 X 32.5L

DD-1048



*Positive
*50A/24~32V, 1 μ A
*Avalanche diode
*Motorola Type
*Diameter(mm):12.8
*Lead(mm):1.3 X 32.5L

Diode & Diode Trio

DD-1053



- *Negative
- *50A/24~32V, 1 μ A
- *Avalanche diode
- *Bosch Pressfit Type
- *Diameter(mm):12.8
- *Lead(mm):1.3 X 34L

DD-1054



- *Positive
- *50A/24~32V, 1 μ A
- *Avalanche diode
- *Bosch Pressfit Type
- *Diameter(mm):12.8
- *Lead(mm):1.3 X 34L

DD-1055



- *Negative
- *25A/400, 4 μ A
- *Pressfit Fork Lead
- *Hitachi Type
- *Diameter(mm):11

DD-1056



- *Positive
- *25A/400, 4 μ A
- *Pressfit Fork Lead
- *Hitachi Type
- *Diameter(mm):11

Diode & Diode Trio

DD-1059



*Negative
*35A/400V, 4 μ A
*Pressfit Straight Lead
*Hitachi Type
*Diameter(mm):11.7
*Lead(mm):1.5 X min.23L

DD-1060



*Positive
*35A/400V, 4 μ A
*Pressfit Straight Lead
*Hitachi Type
*Diameter(mm):11.7
*Lead(mm):1.5 X min.19L

DD-1061



*Negative
*50A/400V, 4 μ A
*Pressfit Straight Lead
*Diameter(mm):1/2"mm
*Lead(mm):2.5 X 23.5L

DD-1062



*Positive
*50A/400V, 4 μ A
*Pressfit Straight Lead
*Diameter(mm):1/2"mm
*Lead(mm):2.5 X 23.5L

Diode & Diode Trio

DD-1063



*Negative
*50A/19~24V, 1 μ A
*Avalanche diode
*Motorola Type
*Diameter(mm):12.8
*Lead(mm):1.3 X 32.5L

DD-1064



*Positive
*50A/19~24V, 1 μ A
*Avalanche diode
*Motorola Type
*Diameter(mm):12.8
*Lead(mm):1.3 X 32.5L

DD-1065



*Negative
*25A/400V, 4 μ A
*Pressfit Straight Lead
*Hitachi Type
*Diameter(mm):11.7
*Lead(mm):1.5 X min.23L

DD-1066



*Positive
*25A/400V, 4 μ A
*Pressfit Straight Lead
*Hitachi Type
*Diameter(mm):11.7
*Lead(mm):1.5 X min.19L

Diode & Diode Trio

DD-1067



- *Negative
- *50A/400V, 4 μ A
- *Pressfit Straight Lead
- *Hitachi Type
- *Diameter(mm):11.7
- *Lead(mm):1.5 X min.23L

DD-1068



- *Positive
- *50A/400V, 4 μ A
- *Pressfit Straight Lead
- *Hitachi Type
- *Diameter(mm):11.7
- *Lead(mm):1.5 X min.19L

DD-1069



- *Negative
- *50A/24~32V, 1 μ A
- *Pressfit Avalanche
- *Hitachi Type
- *Diameter(mm):11.7
- *Lead(mm):1.5 X min.23L

DD-1070



- *Positive
- *50A/24~32V, 1 μ A
- *Pressfit Avalanche
- *Hitachi Type
- *Diameter(mm):11.7
- *Lead(mm):1.5 X min.19L

Diode & Diode Trio

DD-1071



*Negative
*50A/400V, 4 μ A
*Dish Type
*Diameter(mm):9.5
*Lead(mm):1.5 X min.21.5L

DD-1072



*Positive
*50A/400V, 4 μ A
*Dish Type
*Diameter(mm):9.5
*Lead(mm):1.5 X min.17.8L
*

DD-1073



*Negative
*50A/400V, 4 μ A
*Straight Lead, Tin Can
*Diameter(mm):5/16"mm
*Lead(mm):1.5 X 26L
*

DD-1074



*Positive
*50A/400V, 4 μ A
*Straight Lead, Tin Can
*Diameter(mm):5/16"mm
*Lead(mm):1.5 X 26L

Diode & Diode Trio

DD-1075



*Negative
*35A/400V, 4 μ A
*Fork Lead, Tin Can
*Diameter(mm):5/16"mm
*Lead(mm):1.5 X 26L

DD-1076



*Positive
*35A/400V, 4 μ A
*Fork Lead, Tin Can
*Diameter(mm):5/16"mm
*Lead(mm):1.5 X 26L

DD-1077



*Negative
*35A/24~32V, 1 μ A
*Avalanche diode
*Motorola Type
*Diameter(mm):12.8
*Lead(mm):1.3 X 32.5L

DD-1078



*Positive
*35A/24~32V, 1 μ A
*Avalanche diode
*Motorola Type
*Diameter(mm):12.8
*Lead(mm):1.3 X 32.5L

Diode & Diode Trio

DD-1079



*Negative
*35A/19~24V, 1 μ A
*Avalanche diode
*Motorola Type
*Diameter(mm):12.8
*Lead(mm):1.3 X 32.5L

DD-1080



*Positive
*35A/19~24V, 1 μ A
*Avalanche diode
*Motorola Type
*Diameter(mm):12.8
*Lead(mm):1.3 X 32.5L

DD-1081



*Negative
*35A/32~40V, 1 μ A
*Avalanche diode
*Motorola Type
*Diameter(mm):12.8
*Lead(mm):1.3 X 32.5L

DD-1082



*Positive
*35A/32~40V, 1 μ A
*Avalanche diode
*Motorola Type
*Diameter(mm):12.8
*Lead(mm):1.3 X 32.5L

Diode & Diode Trio

DD-1083



*Negative
*70A/24~32V, 1 μ A
*Avalanche diode
*Motorola Type
*Diameter(mm):12.8
*Lead(mm):1.3 X 32.5L

DD-1084



*Positive
*70A/24~32V, 1 μ A
*Avalanche diode
*Motorola Type
*Diameter(mm):12.8
*Lead(mm):1.3 X 32.5L

DD-1085



*Negative
*35A/400V, 4 μ A
*Dish Type
*Diameter(mm):8.4
*Lead(mm):1.5 X min.21.5L

DD-1086



*Positive
*35A/400V, 4 μ A
*Dish Type
*Diameter(mm):8.4
*Lead(mm):1.5 X min.17.8L

Diode & Diode Trio

DD-1087



*Negative
*70A/32~40V, 1 μ A
*Avalanche diode
*Motorola Type
*Diameter(mm):12.8
*Lead(mm):1.3 X 32.5L

DD-1088



*Positive
*70A/32~40V, 1 μ A
*Avalanche diode
*Motorola Type
*Diameter(mm):12.8
*Lead(mm):1.3 X 32.5L

DD-1089



*Negative
*70A/19~24V, 1 μ A
*Avalanche diode
*Motorola Type
*Diameter(mm):12.8
*Lead(mm):1.3 X 32.5L
*M.O.Q. 500EA

DD-1090



*Positive
*70A/19~24V, 1 μ A
*Avalanche diode
*Motorola Type
*Diameter(mm):12.8
*Lead(mm):1.3 X 32.5L
*M.O.Q. 500EA

Diode & Diode Trio

DD-1091



*Negative
*50A/32~40V, 1 μ A
*Avalanche diode
*Motorola Type
*Diameter(mm):12.8
*Lead(mm):1.3 X 32.5L

DD-1092



*Positive
*50A/32~40V, 1 μ A
*Avalanche diode
*Motorola Type
*Diameter(mm):12.8
*Lead(mm):1.3 X 32.5L

DD-1093



*Negative
*35A/24~32V, 1 μ A
*Pressfit Avalanche
*Hitachi Type
*Diameter(mm):11.5
*Lead(mm):1.5 X min.23L

DD-1094



*Positive
*35A/24~32V, 1 μ A
*Pressfit Avalanche
*Hitachi Type
*Diameter(mm):11.5
*Lead(mm):1.5 X min.19L

Diode & Diode Trio

DD-1095



*Negative
*25A/400V, 4 μ A
*Fork Lead, Tin Can
*Diameter(mm):5/16"mm
*Lead(mm):1.5 X 26L

DD-1096



*Positive
*25A/400V, 4 μ A
*Fork Lead, Tin Can
*Diameter(mm):5/16"mm
*Lead(mm):1.5 X 26L

DD-1097



*Negative
*50A/400V, 4 μ A
*Fork Lead, Tin Can
*Diameter(mm):5/16"mm
*Lead(mm):1.5 X 26L

DD-1098



*Positive
*50A/400V, 4 μ A
*Fork Lead, Tin Can
*Diameter(mm):5/16"mm
*Lead(mm):1.5 X 26L

Diode & Diode Trio

DD-1099



*Negative
*25A/400V, 4 μ A
*Pressfit Insulated Lead
*Diameter(mm):1/2"
*Lead(mm):1.3

DD-1100



*Positive
*25A/400V, 4 μ A
*Pressfit Insulated Lead
*Diameter(mm):1/2"
*Lead(mm):1.3

DD-1101



*Negative
*35A/400V, 4 μ A
*Pressfit Insulated Lead
*Diameter(mm):1/2"
*Lead(mm):1.3

DD-1102



*Positive
*35A/400V, 4 μ A
*Pressfit Insulated Lead
*Diameter(mm):1/2"
*Lead(mm):1.3

Diode & Diode Trio

DD-1103



*Negative
*50A/400V, 4 μ A
*Pressfit Insulated Lead
*Diameter(mm):1/2"
*Lead(mm):1.3

DD-1104



*Positive
*50A/400V, 4 μ A
*Pressfit Insulated Lead
*Diameter(mm):1/2"
*Lead(mm):1.3

DD-1105



*Negative
*35A/24~32V, 1 μ A
*Pressfit Avalanche
*Lucas Type
*Diameter(mm):10
*Lead(mm):1.3 X 29L

DD-1106



*Positive
*35A/24~32V, 1 μ A
*Pressfit Avalanche
*Lucas Type
*Diameter(mm):10
*Lead(mm):1.3 X 29L

Diode & Diode Trio

DD-1107



*Negative
*50A/24~32V, 1 μ A
*Pressfit Avalanche
*Lucas Type
*Diameter(mm):10
*Lead(mm):1.3 X 29L

DD-1108



*Positive
*50A/24~32V, 1 μ A
*Pressfit Avalanche
*Lucas Type
*Diameter(mm):10
*Lead(mm):1.3 X 29L

DD-1109



*Negative
*35A/24~32V, 1 μ A
*Avalanche diode
*Bosch Pressfit Type
*Diameter(mm):12.8
*Lead(mm):1.3 X 34L

DD-1110



*Positive
*35A/24~32V, 1 μ A
*Avalanche diode
*Bosch Pressfit Type
*Diameter(mm):12.8
*Lead(mm):1.3 X 34L

Diode & Diode Trio

DD-1111



*Negative
*50A/400V, 4 μ A
*Dish Type
*Diameter(mm):8.4
*Lead(mm):1.5 X min.21.5L

DD-1112



*Positive
*50A/400V, 4 μ A
*Dish Type
*Diameter(mm):8.4
*Lead(mm):1.5 X min.17.8L

DD-1113



*Negative
*25A/400V, 4 μ A
*Dish Type
*Diameter(mm):9.5
*Lead(mm):1.5 X min.21.5L

DD-1114



*Positive
*25A/400V, 4 μ A
*Dish Type
*Diameter(mm):9.5
*Lead(mm):1.5 X min.17.8L

Diode & Diode Trio

DD-1115



*Negative
*35A/400, 4 μ A
*Pressfit Fork Lead
*Hitachi Type
*Diameter(mm):11

DD-1116



*Positive
*35A/400, 4 μ A
*Pressfit Fork Lead
*Hitachi Type
*Diameter(mm):11

DD-1117



*Negative
*50A/400, 4 μ A
*Pressfit Fork Lead
*Hitachi Type
*Diameter(mm):11

DD-1118



*Positive
*50A/400, 4 μ A
*Pressfit Fork Lead
*Hitachi Type
*Diameter(mm):11

Diode & Diode Trio

DD-1119



*Negative
*25A/400V, 4 μ A
*Pressfit Straight Lead
*Lucas Type
*Diameter(mm):10
*Lead(mm):1.3 X 29L

DD-1120



*Positive
*25A/200V, 4 μ A
*Pressfit Straight Lead
*Lucas Type
*Diameter(mm):10
*Lead(mm):1.3 X 29L

DD-1121



*Negative
*50A/400V, 4 μ A
*Pressfit Straight Lead
*Lucas Type
*Diameter(mm):10
*Lead(mm):1.3 X 29L

DD-1122



*Positive
*50A/400V, 4 μ A
*Pressfit Straight Lead
*Lucas Type
*Diameter(mm):10
*Lead(mm):1.3 X 29L

Diode & Diode Trio

DD-1125



*Negative
*70A/400V, 4 μ A
*Pressfit Straight Lead
*Diameter(mm):1/2"mm
*Lead(mm):2.5 X 23.5L

DD-1126



*Positive
*70A/400V, 4 μ A
*Pressfit Straight Lead
*Diameter(mm):1/2"mm
*Lead(mm):2.5 X 23.5L

DT-02

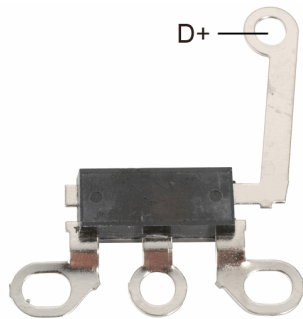

Replaces

DELCO :
1984032 3472312 7962635 DR3901
OPEL :
1205436

DT-07

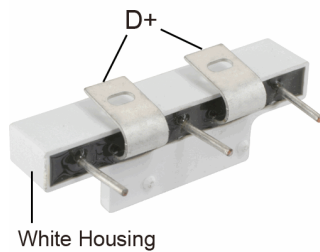

Replaces

VALEO(DUCELLIER) :
669303

Diode & Diode Trio

DT-08



DT-09

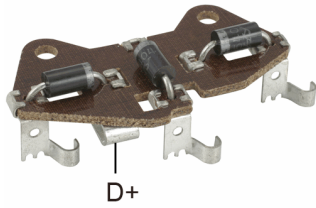

Replaces

BOSCH :

1-121-009-003	1121098002	1121099002	1121099003	1121099005	1121099006
1121099007	1121099008	1121099009	1121099010	1121099011	

DT-13

Replaces

LEECE NEVILLE :

79027

DT-14

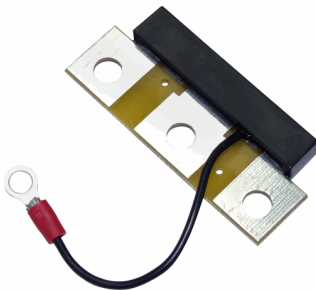

Replaces

LEECE NEVILLE :

79480

Unit no.

LEECE NEVILLE

3425-3725L 4525-4725J

Diode & Diode Trio

DT-15

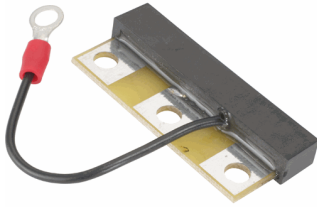

Replaces

LEECE NEVILLE :
79026

DT-17

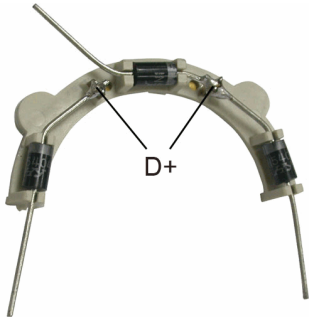

Replaces

BOSCH :
9-121-450-594

DT-18

*For DELCO 22SI Alternators

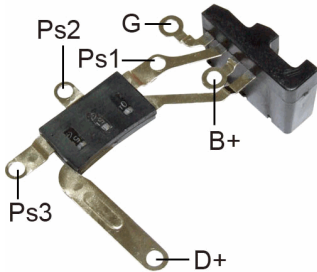

Replaces

DELCO :
10487805